





















 Summary	 Sommaire	 Sumario	 Inhaltsangabe
--	--	---	---

<b>1</b>	<b>Informazioni</b>	 Information	
		 Renseignements	
		 Informaciones	
		 Informationen	
<b>2</b>	<b>Lame circolari</b>	 Circular saw blades	
		 Lames circulaires	
		 Sierras circulares	
		 Kreissägeblätter	
<b>3</b>	<b>Frese saldobrasate HS e HW</b>	 Cutters with HS/HW brazed tips	
		 Fraises à mises rapportées en HS et HW	
		 Fresas con dientes soldados de HS y HW	
		 Bestückte Fräse mit HS und HW Messer	
<b>4</b>	<b>Teste con inserti reversibili</b>	 Cutter heads with turnover knives	
		 Porte-outils à plaquettes réversibles	
		 Cabezales con cuchillas reversibles	
		 Wendepatte-Messerköpfe	
<b>5</b>	<b>Teste con inserti profilati</b>	 Cutter heads with profiled plates	
		 Porte-outils à plaquettes profilées	
		 Cabezales con cuchillas perfiladas	
		 Messerköpfe mit Profilplatten	
<b>6</b>	<b>Punte e utensili per centri di lavoro</b>	 Bits and tools for CNC machining centres	
		 Mèches et outils pour CNC	
		 Brocas y herramientas por CNC	
		 Bohrer und Werkzeuge für CNC	
<b>7</b>	<b>Utensili in DP</b>	 DP Tools	
		 Outils en DP	
		 Herramientas de DP	
		 DP Werkzeuge	
<b>8</b>	<b>Accessori e Ricambi</b>	 Complementary items and Spare parts	
		 Accessoires et rechanges	
		 Accesorios y repuestos	
		 Zubehör und Ersatzteile	
<b>9</b>	<b>Attrezzature per Infissi</b>	 Window tool sets	
		 Outillage pour fenêtres	
		 Herramientas para ventanas	
		 Fenster-Garnituren	



Information	Renseignements	Informaciones	Informationen
Introduzione	1.2	Introduction	1.2
		Introduction	1.2
		Introduccion	1.2
		Einführung	1.2
Tecnologia applicata	1.3	Applied technology	1.3
		Technologie appliquée	1.3
		Tecnología aplicada	1.3
		Angewandte Technologie	1.3
Sigle - Simboli	1.4	Initials - Symbols	1.4
		Sigles - Symboles	1.4
		Siglas - Pictogramas	1.4
		Kurzzeichen - Piktogramme	1.4
Utensili speciali	1.6	Special tools	1.6
		Outils speciaux	1.6
		Herramientas especiales	1.6
		Werkzeuge in Sonderfertigung	1.6
Impiego degli utensili	1.7	Tool usage	1.7
		Emploi des outils	1.7
		Empleo de las herramientas	1.7
		Werkzeug - Verwendung	1.7
Dati tecnici	1.8	Technical data	1.8
		Données techniques	1.8
		Datos tecnicos	1.8
		Technische Daten	1.8
Condizioni di vendita	1.11	General terms of sale	1.11
		Conditions generales de vente	1.11
		Condiciones generales de venta	1.11
		Allgemeine Verkaufsbedingungen	1.11



Gli utensili per la lavorazione del legno illustrati in questo catalogo sono per la maggior parte prodotti in serie e disponibili a magazzino, e costituiscono una gamma completa che permette di soddisfare in tempi brevi ed a prezzi competitivi le richieste dei nostri clienti.

Tutti gli utensili elencati sono conformi alla normativa sulla sicurezza degli utensili EN 847-1/2 e quindi rispondenti ai requisiti sulla prevenzione degli infortuni.

La particolare attenzione che poniamo alle sempre crescenti esigenze del mercato ci induce ad una costante ricerca di nuove soluzioni tecniche e nuove proposte commerciali.

La progettazione basata su oltre 50 anni di esperienza, l'utilizzo di materiali appropriati, l'uso di tecnologie avanzate, gli assidui controlli qualitativi, garantiscono la produzione di utensili di precisione di ottima qualità.

## Introduction

The woodworking tooling shown in this catalogue is mainly our series production tooling and is usually available from stock. It forms a comprehensive and competitively priced range of tooling that is able to rapidly satisfy customer demand.

All the listed tools are manufactured to conform with the requirements detailed on EEC directives EN 847-1/2 which address the safety aspects in order to reduce the probability of accident.

The particular attention we pay to the growing market demands, gives us the impetus for constant research for new and innovative technology and new business opportunities.

Our designs based on more than 50 years experience, the use of the most appropriate materials, advanced technology and strict quality control procedures, guarantee the production of precision tooling of the highest quality.

## Introduction

Les outils pour le travail du bois illustrés dans ce catalogue sont fabriqués pour la plupart en série et disponibles en stock et ils constituent une gamme complète que peut répondre très rapidement et à prix compétitifs à toutes les demandes de nos clients.

Tous nos produits sont conformes à la norme européenne sur la sûreté des outils EN 847-1/2 et donc répondent à les qualité requises pour la prévention des accidents.

L'attention particulière que nous adressons aux exigences continues du marché nous porte à une recherche constante de nouvelles solutions techniques et nouvelle offres commerciales.

Le project basé sur plus de 50 ans d'expérience, utilisation de matériaux appropriés, l'emploi des technologies de pointe et les contrôles fréquents de la qualité, garantissent la production d'outils de précision et d'excellent qualité.

## Introducción

Las herramientas para la elaboración de la madera ilustradas en este catalogo son producidas en sus mayor parte en serie y se encuentran disponibles en almacen. Ellas constituyen, por lo tanto, una gama completa que permite satisfacer en un tiempo breve y a precios competitivos las exigencias de nuestros clientes.

Todas las herramientas listadas son conformes a la normativa sobre la seguridad de las herramientas EN 847-1/2 para la prevención de los accidentes.

La grande atención que ponemos en las exigencias del mercado en continuo aumento, nos induce a buscar nuevas soluciones técnicas y nuevas propuestas comerciales.

El proyecto que se basa en mas de 50 años de experiencia, la utilización de tecnologías avanzadas, las frecuentes inspecciones cualitativas, aseguran la producción de herramientas de precisión de calidad excelente.

## Einführung

Die Werkzeuge für die Holzbearbeitung die in diesem Katalog beschreiben werden, sind zum Grossteil in Serie hergestellt und ab Lager zu Verfügung. Sie bestehen aus einer vollständigen Auswahl, die uns erlaubt, kurzfristig und konkurrenzfähig die Anfragen unserer Kunden zufriedenzustellen.

Alle Werkzeuge entsprechen den Rechtsvorschriften EN 847-1/2 über die Sicherheit der Werkzeuge.

Unsere Aufmerksamkeit zum Marktansprüchen, bringt uns zu einer beständiger Suche von neuer technischer Lösungen und neuer Geschäfts-vorschlag.

Die Planung gestützt über 50 Erfahrungsjahre, der Gebrauch der geeigneter Materialien, die sorgfältige Qualitätprüfungen, sichern die Herstellung von feiner Werkzeuge von hochwertiger Qualität.



## 3D CAD-CAM



## MATERIALS





## MACHINING



## TESTING



 Applied technology.

 Tecnología aplicada.

 Technologie appliquée.

 Angewandte technologie.



Initials - Symbols



Sigles - Symboles



Siglas - Pictogramas



Kurzzeichen - Piktogramme

<b>a</b>	<b>= Spessore del coltello</b>
	Knife thickness
	Epaisseur du couteau
	Espesor de la cuchilla
	Messerdicke
<b>A1</b>	<b>= Interasse fori</b>
	Pin hole distance
	Distance entre les trous
	Distancia entre los agujeros auxiliares
	Nebenlöcher Abstand
<b>A2</b>	<b>= Interasse fori</b>
	Pin hole distance
	Distance entre les trous
	Distancia entre los agujeros auxiliares
	Nebenlöcher Abstand
<b>b</b>	<b>= Profondità ripresa</b>
	Depth of the recess
	Profondeur de creux
	Profundidad del collar
	Rastetiefe
<b>B</b>	<b>= Altezza totale del tagliente</b>
	Tool width
	Largeur de coupe
	Ancho de corte
	Werkzeugbreite
<b>B1</b>	<b>= Spessore del corpo</b>
	Thickness of the tool body
	Epaisseur du corps de l'outil
	Espesor del cuerpo de la herramienta
	Werkzeug-Körper Dicke
<b>B3</b>	<b>= Spessore min. del dente conico</b>
	Min. width of the conical tooth
	Largeur min. du dent conique
	Espesor min. del diente cónico
	Min. Schnittbreite des Konischzahns
<b>B4</b>	<b>= Spessore max. del dente conico</b>
	Max. width of the conical tooth
	Largeur max. du dent conique
	Espesor max. del diente cónico
	Max. Schnittbreite des Konischzahns
<b>C</b>	<b>= Spessore del tenone</b>
	Thickness of the tenon
	Epaisseur du tenon
	Espesor de la espiga
	Zapfendicke

<b>COD</b>	<b>= Codice articolo</b>
	Code of the item
	Code de l'article
	Código del artículo
	Artikel-Kodex
<b>d</b>	<b>= Diametro del foro</b>
	Bore diameter
	Diamètre de l'alésage
	Diametro del agujero
	Bohrungsdurchmesser
<b>D</b>	<b>= Diametro esterno tagliente</b>
	Tool cutting diameter
	Diamètre extérieur coupant
	Diametro de la herramienta
	Werkzeugdurchmesser
<b>D1</b>	<b>= Diametro ripresa</b>
	Diameter of the recess
	Diamètre du creux
	Diametro del collar
	Rastedurchmesser
<b>D2</b>	<b>= Diametro della testa porta-coltelli</b>
	Diameter of the cutter head
	Diamètre du porte-outil
	Diametro del cabezal
	Messerkofdurchmesser
<b>DP</b>	<b>= Diamante policristallino</b>
	Polycrystalline diamond
	Diamant polycristalline
	Diamante policristalino
	Polykristalldiamanten
<b>E</b>	<b>= Dimensione chiave esagonale</b>
	Size of hexagonal wrench
	Dimension clé exahagonale
	Dimensión llave exahagonale
	Sechskant-Schlüssel Abmessung
<b>H</b>	<b>= Larghezza del coltello</b>
	Knife width
	Largeur du couteau
	Altura de la cuchilla
	Messerhöhe
<b>HL</b>	<b>= Acciaio altamente legato</b>
	High-alloyed steel
	Acier fortement allié
	Acero de alta aleación
	Hochlegierter Stahl

<b>HS</b>	<b>= Acciaio super - rapido (ex HSS)</b>
	High speed steel (ex HSS)
	Acier super-rapide (ex HSS)
	Acero super-rápido (ex HSS)
	Hochleistungsschnellstahl (ex HSS)
<b>HW</b>	<b>= Carburo di tungsteno (ex HM)</b>
	Tungsten carbide (ex HM)
	Carbure de tungstène (ex HM)
	Métal duro (ex HM)
	Hartmetall (ex HM)
<b>L</b>	<b>= Lunghezza utile</b>
	Cutting length
	Longueur utile
	Largo útil
	Nutzlänge
<b>L1</b>	<b>= Lunghezza del corpo-mandrino</b>
	Length of the chuck-body
	Longueur du corps du mandrin
	Largo del cuerpo del mandril
	Länge des Spannfutterkörpers
<b>LH</b>	<b>= Rotazione sinistra</b>
	Left-hand rotation
	Rotation à gauche
	Giro a izquierda
	Linkslauf
<b>LS</b>	<b>= Leva-spigoli</b>
	Edge-breakers
	Brise-arêtes
	Mata-cantos
	Kantenbrecher
<b>LT</b>	<b>= Lunghezza totale</b>
	Overall length
	Longueur totale
	Largo total
	Gesamtlänge
<b>M</b>	<b>= Filettatura metrica</b>
	Metric Thread
	Filetage métrique
	Filete métrico
	Metrisches Gewinde
<b>MAN</b>	<b>= Avanzamento manuale</b>
	Manual feed
	Avancement manuelle
	Avance manual
	Handvorschub







 Initials - Symbols

 Sigles - Symboles





 Siglas - Pictogramas

 Kurzzeichen - Piktogramme

## MAT = Qualità del tagliente

	Cutting edge material
	Qualité du matériel de coupe
	Calidad del cortante
	Schneidenwerkstoff





## MEC = Avanzamento meccanico

	Mechanical feed
	Avancement mécanique
	Avance mecànico
	Mechanischer Vorschub





## MK = Cono Morse

	Morse taper
	Cone morse
	Cono morse
	Morsekonus





## n = Numero di giri / 1'

	R.P.M.
	Nombre de tours / 1'
	Numéro de revoluciones / 1'
	Umdrehung / 1'

## n max = Velocità di rotazione massima

	Max. R.P.M.
	Max. Vitesse de rotation permis
	Max. velocidad de rotación consentida
	Max. Zulässige Drehzahl

## P = Profondità del profilo

	Profile depth
	Profondeur du profil
	Profundidad del perfil
	Profiltiefe

## Q = Quantità

	Quantity
	Quantité
	Cantidad
	Menge





## R = Raggio

	Radius
	Rayon
	Radio
	Radius

## RH = Rotazione destra

	Right-hand rotation
	Rotation à droite
	Giro a derecha
	Rechtslauf





## S = Gambo cilindrico

	Cylindrical shank
	Queue cylindrique
	Mango cilíndrico
	Zylindrischer Schaft





## SP = Acciaio legato

	Alloyed steel
	Acier allié
	Acero aleado
	Legierter Stahl





## T = Profondità max. della fresatura

	Max. milling depth
	Max. profondeur de fraisage
	Profundidad max. de fresado
	Max. Fraesungtiefe

## V = Numero dei rasanti





	Number of spurs
	Numéro de araseurs
	Numéro de precortadores
	Vorschneiderzahl

## Z = Numero di taglienti





	Number of teeth
	Numéro de dents
	Numéro de dientes
	Zähnezahl





## = Senza leva-spigoli

	Without edge-breakers
	Sans brise-arêtes
	Sin mata-cantos
	Ohne Kantenbrechern





## 45° = Con leva-spigoli 45°

	With 45° edge-breakers
	Avec brise-arêtes 45°
	Con mata-cantos 45°
	Mit Kantenbrechern 45°





## R 1.5 = Con leva-spigoli R=1.5

	With R=1.5 edge-brakers
	Avec brise-arêtes R=1.5
	Con mata-cantos R=1.5
	Mit Kantenbrechern R=1.5





## R 3 = Con leva-spigoli R=3

	With R=3 edge-breakers
	Avec brise-arêtes R=3
	Con mata-cantos R=3
	Mit Kantenbrechern R=3

## R 5 = Con leva-spigoli R=5

	With R=5 edge-breakers
	Avec brise-arêtes R=5
	Con mata-cantos R=5
	Mit Kantenbrechern R=5

## ∞ = Angolo inclinazione del profilo

	Angle of profile inclination
	Angle d'inclination du profil
	Angulo de inclinación del perfil
	Neigungswinkel des Profils



La produzione di utensili speciali soddisfa specifiche richieste che per forma, dimensioni, tipo di attacco, produttività, etc. non trovano riscontro nella gamma di utensili di serie.

Se la richiesta riporta tutti i dati utili alla progettazione degli utensili speciali, relativi sia al materiale da fresare che alle caratteristiche tecniche della macchina usata, questi offriranno il miglior rendimento sia produttivo che qualitativo.

## Special tools

The production of custom-made tools satisfies specific requirements connected to the shape, size, type of shank, productivity, etc. that cannot be found in the range of the standard tools.

If the request includes all the relevant information regarding the design of the special tools, connected to the material to be machined and to the technical data of the machine used, then we will be able to offer the best performance both in productivity and quality.

## Outils speciaux

La production d'outils speciaux satisfait demandes particulière que pour forme, dimensions, modèle de queue, productivité etc. ne trouvent pas confirmation dans la gamme d'outils de série.

Si la demande mentionne tous les éléments nécessaires pour le plan des outils speciaux, relatifs soit à le materiel à fraiser que aux caractéristiques techniques de la machine utilisée, ceux offriront le meilleure rendement de production et qualitatif.

## Herramientas especiales

La produccion de herramientas especiales satisfa las peticiones que per forma, dimensiones, tipo de mango, productividad, etc. no corresponden a la gama de herramientas producidas en serie.

Si la peticion tiene todos los datos necesario a la creacion de las herramientas especiales, relativos tanto al material de fresar como a las características técnicas de la maquina usada, estas herramientas ofreceran el mejor rendimiento productivo y cualitativo.

## Werkzeuge in Sonderfertigung

Die Herstellung der Werkzeuge in Sonderfertigung befriedige die Anfragen, dass für Form, Dimensionen, Schaftabmessung, Produktivität, usw in Serie hergestellten sind nicht.

Wenn die Anfrage alle nützliche Auskünfte, wie das Material zu fräsen und die technische Daten der gebrauchte Maschine enthält, die Werkzeuge die bessere Produktiv-und-Qualitativleistung haben.

# Impiego degli utensili



🇬🇧 Tool usage. 
 🇫🇷 Emploi des outils. 
 🇪🇸 Empleo de las herramientas. 
 🇩🇪 Werkzeug-Verwendung

## SENSO DI ROTAZIONE

In mancanza di specifica la rotazione dell' utensile é da intendersi " RH "

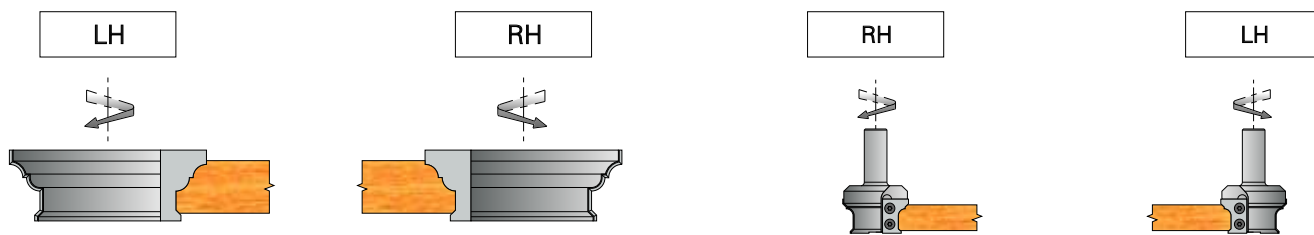

🇬🇧 **Rotation wise.** If it is not specified, the tool rotation is " RH ".  
🇫🇷 **Sens de rotation.** Quand il n'y a aucune spécification, la rotation de l' outil s'entende " RH ".  
🇪🇸 **Sentido de rotacion.** En ausencia de especificaciones, la rotacion de la herramienta debe entenderse " RH ".  
🇩🇪 **Rotationweise.** Man hält die Rotation des Werkzeuges "RH", wenn keine Spezifikation angeben ist.

## VELOCITA' DI ROTAZIONE

Rispettare le indicazioni riportate sull' utensile ( n o n max )



🇬🇧 **Rotation speed.** Observe the instructions marked on the tool.  
🇫🇷 **Vitesse de rotation.** Respecter les indications marqués sur l' outil.  
🇪🇸 **Velocidad de rotacion.** Respetar las indicaciones reflejadas sobre la herramienta.  
🇩🇪 **Rotationgeschwindigkeit.** Man soll die Anweisungen auf den Werkzeugen beachten.

## TIPO DI AVANZAMENTO

Gli utensili marcati **MAN** possono essere usati con avanzamento manuale del pezzo in direzione contraria alla rotazione dell' utensile.

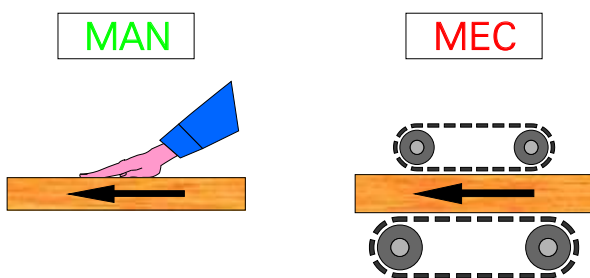

Gli utensili marcati **MEC** devono essere usati per lavorazione con avanzamento meccanico.

🇬🇧 **Kind of feed motion.** The tools marked **MAN** may be used with manual feed of the piece following the opposite direction of the tool rotation. The tools marked **MEC** must be used for working with mechanical feed.  
🇫🇷 **Type d' avancement.** Les outils marqués **MAN** peuvent être employés avec avancement manuel de la pièce en direction contraire à la rotation de l' outil. Les outils marqués **MEC** doivent être employés pour le travail avec avancement mécanique.  
🇪🇸 **Tipo de avance.** Las herramientas marcadas **MAN** pueden ser usadas con avance manual de la pieza en direccion contraria a la rotacion de la herramienta. Las herramientas marcadas **MEC** deben ser usadas para trabajos con avance mecanico.  
🇩🇪 **Vorschub-art.** Die Werkzeuge mit dem Zeichen **MAN** können mit dem Handvorschub des Stücks in Gegenlauf benutzen werden. Die Werkzeuge mit dem Zeichen **MEC** müssen mit mechanischen Vorschub benutzen werden.

## VELOCITA' DI AVANZAMENTO

Attenersi al diagramma Tab. 3



🇬🇧 **Feed rate.** Follow the chart Tab. 3.  
🇫🇷 **Vitesse d' avancement.** Suivre le diagramme Tab. 3.  
🇪🇸 **Velocidad de avance.** Atenerse al diagrama Tab. 3.  
🇩🇪 **Vorschubgeschwindigkeit.** Tab. 3 befolgen.





## Dati tecnici

## Tab. 1

		TECHNICAL DATA			
		DONNEES TECHNIQUES			
		DATOS TECNICOS			
		TECHNISCHE DATEN			
		MATERIALS	MATERIAUX	MATERIALES	WERKSTOFF
		NATURAL WOOD	BOIS NATURELS	MADERAS	NATURHÖLZER
		Softwood	Bois tendres	Madera blanda	Weichholz
		Hardwood	Bois durs	Madera dura	Hartholz
		Veneers	Pièces	Chapas finas	Furniere
		RAW CHIPBOARDS Plywood	PANNEAUX NON PLAQUES Panneaux contreplaqués	TABLEROS SIN RECHAPAR Tableros compensados	UNBELEGTE SPANPLATTEN Sperrholzplatten
		Blockboard	Panneaux latés	Tableros alistados	Tischlerplatten
		Raw chipboard	Panneaux de particules bruls	Tableros aglomerados en bruto	Rohtspanplatten
		Fibreboard	Panneaux - fibres	Tableros de fibras	Faserplatten
		VENERED BOARDS	PANNEAUX PLAQUES	TABLEROS RECHAPADOS	FURNIERTE PLATTEN
		Veneers	Pièces	Chapas finas	Furniere
		Plastic laminated	Laminifés	Estratificados	Kunststoffe
		High pressure laminated	Stratifiés	Melamina	Schichtstoffe
		PLASTIC	MATERIES PLASTIQUES	PLASTICOS	KUNSTOFFE
		Plastic laminated	Laminifés	Estatificados	Kunststoffe
		Thermoplastics	Termoplastiques	Termoplásticos	Termoplastik
		Duroplastics	Duroplastiques	Duroplásticos	Duroplastik
		Plastic profiles	Profils plastiques	Perfiles plásticos	Kunststoffprofile
		CARD-BOARDS	CARTONS	CARTONES	KARTONE
		LIGHT-ALLOYS PROFILES	ALLAGES-LEGERES	PERFILES DE LIGAS LIGERAS	LEICHT - METALLE PROFILE
		ARTICOLO			
		Article number	Numéro de l'article	Número del artículo	Artikelnummer
		312 318 324 326 328 329 330 331 333 334 336 338 339 340 346 357 358	325	332 337	341 342 343 344
		314 320			
		316 323			
		CONDIZIONI D' IMPIEGO			
		Parameters for woodworking			
		Conditions of utilisation			
		Condiciones de trabajo			
		Einsatzbedingungen			
		Velocità periferica	Asportazione dente		
		Cutting speed	Feed rate/tooth		
		Vitesse de coupe	Avance/dent		
		Velocidad de corte	Avance/diente		
		Schnittgeschwindigkeit	Vorschub/Zahn		
		$V_p = 3,14 \times \frac{D \times n}{1.000 \times 60}$	$sz = \frac{V_a}{n \times Z}$		
		m/sec.	mm.		
		60 ÷ 90	0.1 ÷ 0.2		
		60 ÷ 90	0.1 ÷ 0.2		
		50 ÷ 85	0.1 ÷ 0.2		
		50 ÷ 85	0.1 ÷ 0.2		
		70 ÷ 100	0.1 ÷ 0.2		
		LEGNI NATURALI			
		Legni teneri			
		Taglio long.			
		Taglio trasv.			
		Legni duri e abrasivi			
		Taglio long.			
		Taglio trasv.			
		( a pacchetto )			
		PANNELLI DERIVATI DAL LEGNO NON RIVESTITI			
		Compensati			
		Multistrati			
		Pannelli di particelle ( trucolari )			
		Pannelli di fibre ( faesite, M.D. )			
		PANNELLI RIVESTITI			
		con impiallacciatura			
		con laminato plastico ( decorativo )			
		con carta melaminica ( nobilitati )			
		MATERIE PLASTICHE			
		Laminati plastici ( a pacchetto )			
		Termoindurenti			
		Duroplastici			
		Profili plastici			
		CARTONI			
		40 ÷ 60			
		0.03 ÷ 0.06			
		40 ÷ 70			
		●			



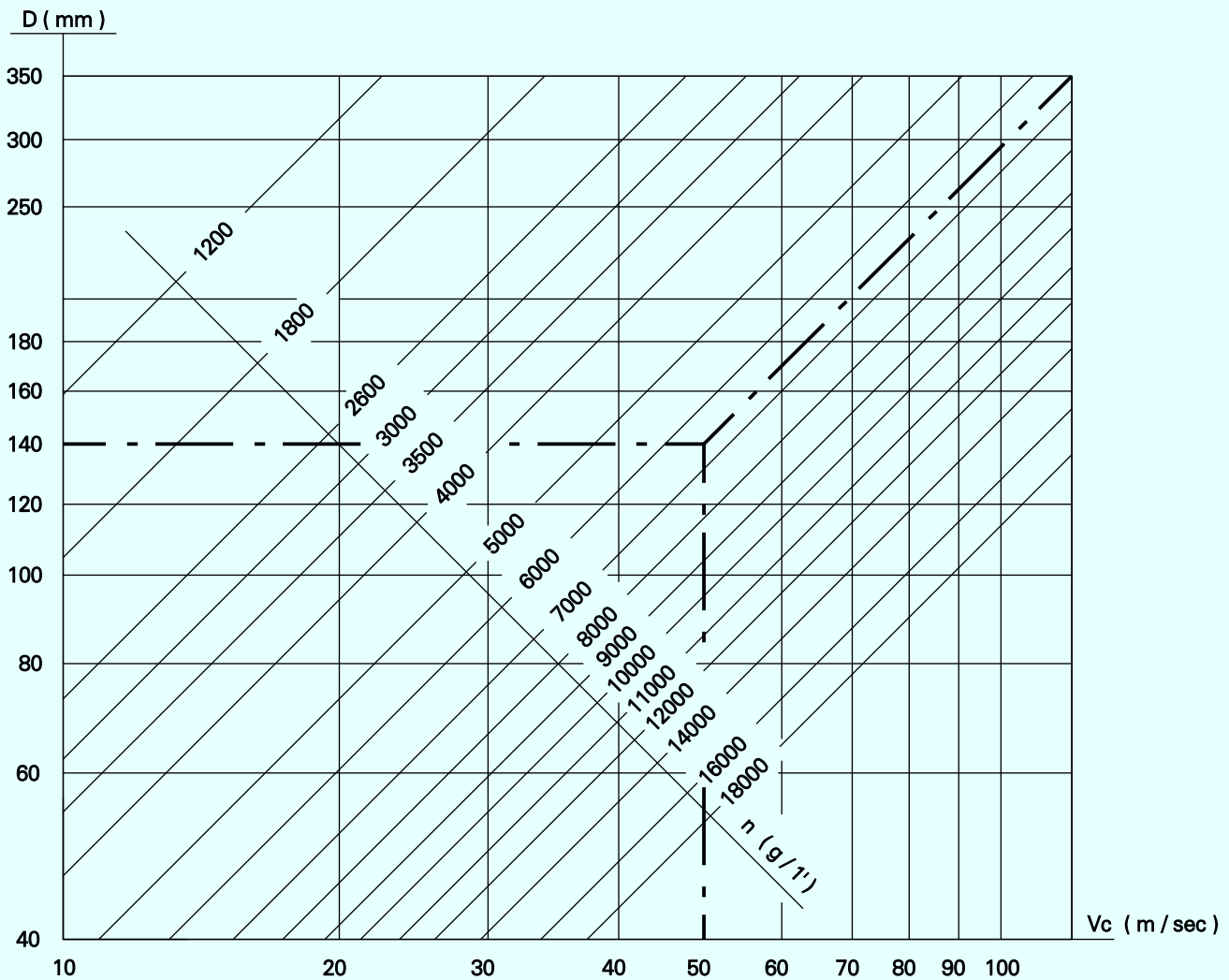

DIAGRAMMA PER RILEVARE IL NUMERO DEI GIRI DEGLI UTENSILI IN RAPPORTO AL DIAMETRO ED ALLA VELOCITA' DI TAGLIO PRESCELTA.



Esempio :  $D=140$   $V_c=50$   $n = \frac{V_c \times 60 \times 1.000}{3.14 \times D} = 6.800 \text{ g/1'}$

MATERIALE	Velocità di taglio consigliate (Vc)				Recommended cutting speed (Vc) for:	Vitesse de coupe (Vc) recommandée pour:	Velocidad de corte (Vc) recomendada para:	Empfohlene Schnitt-Geschwindigkeit (Vc) für:
	SP (m/sec.)	HL (m/sec.)	HS (m/sec.)	HW (m/sec.)	MATERIAL	MATERIEL	MATERIAL	WERKSTOFF
Legni teneri	40 - 50	40 - 50	50 - 65	60 - 70	Soft woods	Bois tendres	Maderas blandas	Weichhölzer
Legni duri			40 - 60	50 - 70	Hard woods	Bois durs	Maderas duras	Harthölzer
Pannelli di part. (truciolari)				60 - 70	Particle board	Panneaux particules	Tableros aglomerados	Spannplatten
Multistrati				60 - 70	Blockboard	Panneaux lattés	Tableros alistonados	Tischlerplatten
Pannelli di fibre				40 - 60	Hard board	Panneaux-fibres durs	Tableros de fibras	Hartfaserplatten

 Determination of the tool rotation speed at a given tool diameter and cutting speed.

 Determinación de la velocidad de rotación de l' herramienta en relación con el diámetro y con la velocidad de corte.

 Détermination de la vitesse de rotation de l' outil en fonction du diamètre et de la vitesse de coupe.

 Ermittlung der Rotationsgeschwindigkeit in Abhängigkeit von der Werkzeugdurchmesser und der Schnittgeschwindigkeit.



DIAGRAMMA PER RILEVARE LA VELOCITA' DI AVANZAMENTO PER DENTE



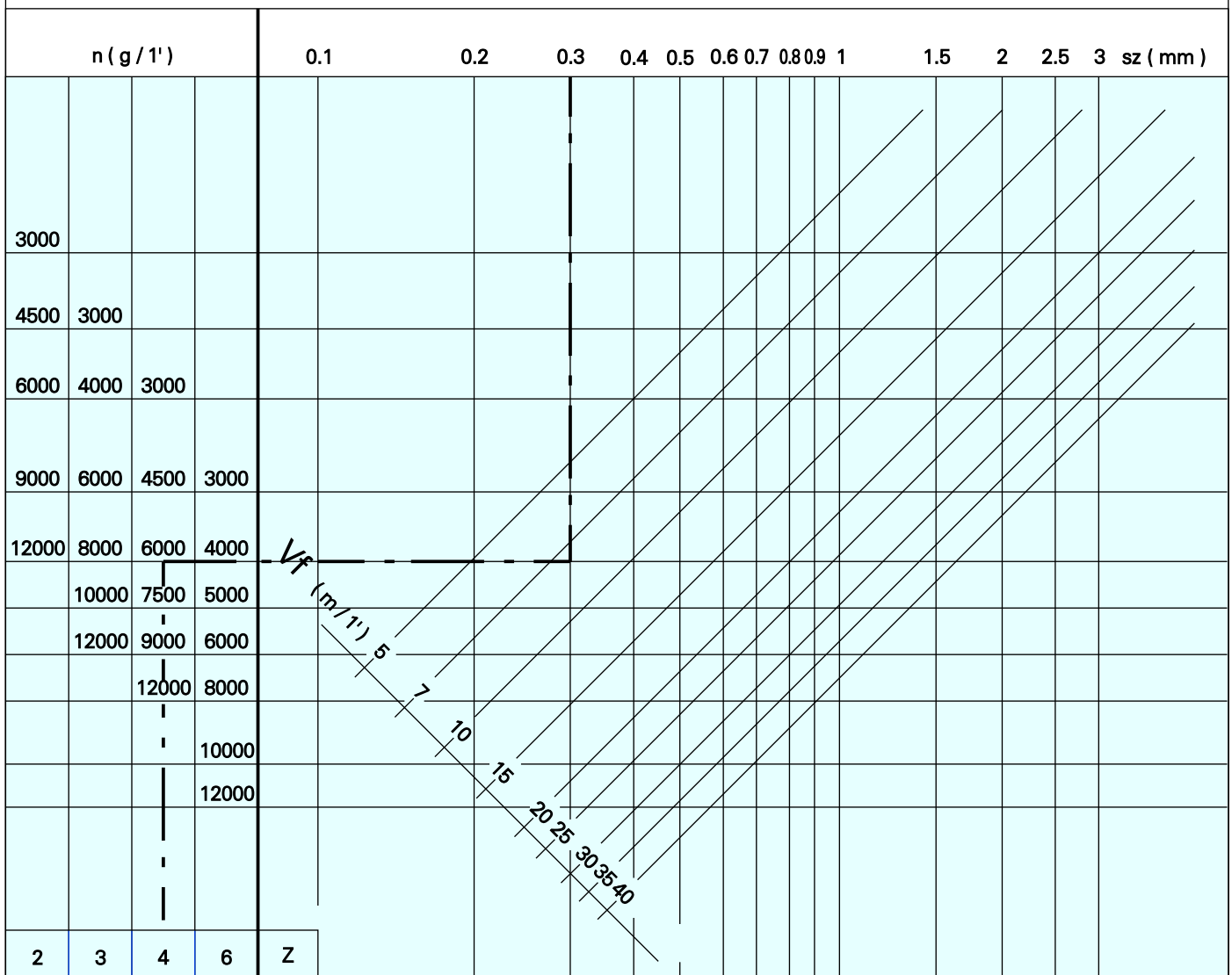

Esempio :  $Z = 4$   
 $n = 6.000$   
 $sz = 0.3 \text{ mm}$

$$V_f = \frac{Z \times n \times sz}{1.000} = 7.2 \text{ m/1'}$$

sz (mm.)	Grado di finitura	Degree of smoothness	Qualità de coupe	Calidad de l' acabado	Glättungsgrad
0.2 ÷ 0.6	Finitura buona	Fine	Fine	Fina	Fein
0.7 ÷ 2	Finitura media	Middle	Moyene	Media	Schlicht
> 2	Sgrossatura	Rough	Dégrossissage	Bruta	Schrupp

 Determination of the feed rate at a given feed rate/tooth.

 Determinación de la velocidad de avance en relación con l' avance/diente.

 Détermination de la vitesse d' avancement en fonction de l' avance/dent.

 Ermittlung der Vorschubsgeschwindigkeit in Abhängigkeit vom Vorschub/Zahn.



a) **ORDINAZIONI**

Le ordinazioni si intendono accettate alle condizioni indicate nella conferma d'ordine e non potranno essere annullate né parzialmente né totalmente. In mancanza di conferma d'ordine valgono le condizioni generali di contratto pattuite con il committente.

b) **TERMINI DI CONSEGNA**

Decorrono dalla data di definizione di tutti i dettagli inerenti l'ordinazione. Possono essere prorogati in conseguenza di impedimenti impreveduti, quali mancata consegna di materie prime, guasti agli impianti, calamità naturali, scioperi, serrate, etc. Non sono ammesse richieste di indennizzo per il mancato rispetto dei termini di consegna.

c) **SPEDIZIONE DELLA MERCE**

La merce viene resa franco sede OMAS e viaggia a rischio e pericolo del destinatario dal momento in cui viene caricata sul mezzo di trasporto, anche se questo è di proprietà OMAS, indipendentemente dalle modalità di pagamento del trasporto. La spedizione viene assicurata solo dietro esplicita richiesta del destinatario. L'imballo è sempre a carico del destinatario.

d) **RESTITUZIONI - RECLAMI**

Non si accettano restituzioni della merce, a nessun titolo, se non preventivamente autorizzate da OMAS. I reclami dovranno essere avanzati per iscritto entro 8 giorni dal ricevimento della merce dovranno contenere la descrizione del difetto riscontrato.

e) **GARANZIA**

La durata della garanzia è conforme alla normativa vigente. La garanzia non copre difetti dovuti a logorio, uso improprio, mancata o errata manutenzione, manipolazioni o modifiche arbitrariamente apportate, né danni causati dal trasporto. Gli utensili che OMAS giudicherà viziati da difetti di fabbricazione o non rispondenti alla richiesta del cliente potranno essere riparati o sostituiti a discrezione del fabbricante. Non vengono accettate richieste di indennizzo dovute alla fornitura di utensili difettosi, né per danni diretti né per danni indiretti, a meno che sia riconosciuta colpa grave a carico del costruttore.

f) **PREZZI**

I prezzi si intendono sempre IVA esclusa, che sarà applicata con l'aliquota in vigore alla data della fatturazione. Salvo accordi particolari comprovati dalla conferma d'ordine, vengono applicati i prezzi di listino in vigore alla data della consegna della merce.

g) **PAGAMENTI**

Gli importi delle fatture vanno pagati per intero alle scadenze stabilite. Tutte le spese accessorie sono a carico del cliente. I pagamenti effettuati tramite banca hanno valore dalla data di arrivo dell'estratto conto bancario. In caso di reclamo relativo a una parte della fornitura non è ammesso ritardo nel pagamento della parte non contestata della fornitura, né tanto meno nel pagamento di altra fornitura. Il mancato rispetto dei termini di pagamento dà diritto a OMAS di sospendere eventuali nuove forniture, di addebitare gli interessi maturati ed ogni altro onere accessorio. In caso di sospensione delle forniture per i motivi di pagamento suddetti, i termini di consegna previsti per dette forniture vengono automaticamente prorogati. La merce rimane proprietà di OMAS fino al pagamento totale della fornitura e delle eventuali spese accessorie.

h) **CONTROVERSIE**

Per dirimere eventuali controversie si applica esclusivamente la legge italiana ed il foro competente è solo quello di Ancona.



a) **ORDERS**

Orders are accepted with the conditions indicated in the order confirmations and cannot be cancelled either in part or completely. Without an order confirmation, the general conditions of the agreement stipulated with the customer are valid.

b) **DELIVERY TERMS**

They start from the date when all the details concerning the order are fixed. They may be extended because of unexpected events such as non-delivery of raw materials, breakdown on the equipment, natural disasters, strikes, lockouts etc. Claims for damages are not accepted if delivery terms are longer.

c) **FORWARDING OF THE GOODS**

Goods are delivered free on our firm and travel at the consignee's own risk from when they are on the vehicle, even if it is OMAS property and independently of payment formalities concerning the transport. Forwarding is covered by an insurance guarantee only if the consignee asked it expressly. Packing is always charged to the consignee.

d) **RETURNS - CLAIMS**

OMAS does not accept returns of the goods if not previously authorized. Claims will have to be put forward in writing within 8 days from the receipt of the goods. A description of the fault is necessary.

e) **GUARANTEE**

The guarantee term is in conformity with the rules in force. The guarantee does not provide for those faults due to wear, improper use, wrong or non-maintenance, handlings or modifications arbitrarily done, damages due to transport. Those tools, that OMAS considers damages by manufacturing defects or different from those ordered by the customer, will be repaired or substituted at maker's discretion. Claims for damages are not accepted if they are due to the supply of faulty tools which could have caused direct or indirect damages, unless the maker is to be blamed for gross negligence in manufacturing.

f) **PRICES**

Prices are considered without V.A.T. which will be imposed with the share in force during the invoicing. Except particular agreements indicated in the order confirmation, we impose the price list in force during the delivery of the goods.

g) **PAYMENTS**

The invoice amount has to be paid in full on stated maturity. All extra charges are at customer's expense. Banking payments are valid from the day of credit on OMAS account. Claims concerning a part of the supply do not involve any delay in the payment of the non-contested supply or the payment of another one. If terms of payment are not honoured OMAS can

interrupt new supplies and debit the accrued interests together with all the necessary extra charges. If supply is postponed because of the above mentioned reasons, delivery terms are automatically extended. Before the total payment of the invoice, and if necessary extra charges, goods are OMAS property.

**h) CONTROVERSY**

To settle a controversy is necessary to enforce the Italian law and the only competent court is in Ancona.



## Conditions generales de vente



**a) COMMANDES**

Les commandes sont acceptées aux conditions indiquées dans la confirmation de commande et elles ne pourront pas être annulées ni partiellement ni totalement. Si il n'y a pas la confirmation de commande seront utilisées les conditions générales du contrat établies avec le commettant.

**b) DELAI DE LIVRAISON**

Il passe depuis la date de définition de tous les détails concernant la commande. Il peut être prorogé à cause d'empêchements imprevisibles comme la livraison manquée des matières premières, les pannes aux installations, les calamités naturelles, les grèves, les grèves - patronales, etc. Les demandes de dommages pour le non - respect du délai de livraison ne sont pas acceptées.

**c) EXPEDITION DE LA MARCHANDISE**

La marchandise est expédiée FRANCO établissement OMAS et elle voyage à risque et péril du destinataire dès lors qu'elle est chargée sur le moyen de transport, même si elle est propriété de la société OMAS, indépendamment des modalités de paiement du transport. L'expédition sera assurée seulement sur demande du destinataire. L'emballage est toujours à charge du destinataire.

**d) RESTITUTIONS - RECLAMATIONS**

La société OMAS n'accepte pas la restitution de la marchandise à aucun titre, si elle n'a pas été préventivement autorisée. Les réclamations devront être avancées par écrit dans 8 jours de la réception de la marchandise et elles devront contenir la description du défaut vérifié.

**e) GARANTIE**

La durée de la garantie est conforme à la norme en vigueur. La garantie ne couvre pas les défauts causés par l'usure, l'emploi impropre (par exemple entretien non correct ou manqué), les manipulations ou les modifications arbitrairement apportées, ni les dommages causés par le transport. Les outils que la société OMAS jugera viciés par un défaut de fabrication ou non correspondants à la demande du client pourront être réparés ou remplacés à discrétion du producteur. La société OMAS n'accepte pas les demandes d'indemnité causées par la fourniture d'outils défectueux, ni pour les dommages directs ou indirects sauf le cas dont on a reconnu une grave responsabilité à charge du fabricant.

**f) PRIX**

Les prix s'entendent toujours sans T.V.A. Sauf que les cas particuliers attestés par la confirmation de commande, sont appliqués les prix du bulletin en vigueur à la date d'expédition de la marchandise.

**g) PAIEMENT**

Les factures doivent être payées entièrement aux échéances prévues. Tous les frais accessoires sont à charge du client. Les paiements effectués par l'entremise de la banque ont valeur de la date d'arrivée sur le compte bancaire. En cas de réclamation d'une partie de la fourniture, la société OMAS n'accepte pas un retard sur le paiement de la partie non contestée de la fourniture, ni d'autres fournitures. Le non - paiement aux termes établis donne le droit à la société OMAS de suspendre les fournitures successives et de débiter les intérêts échus et tous les autres charges accessoires. En cas de suspension des fournitures pour les motifs ci - dessus indiqués, les délais de livraison prévus seront automatiquement prorogés. La marchandise reste de propriété de la société OMAS jusqu'au paiement entière de la fourniture et des éventuels frais accessoires.

**h) CONTROVERSES**

Pour mettre fin aux éventuelles controverses, on doit appliquer exclusivement la loi italienne et le tribunal compétent est seulement celui d'Ancona.



## Condiciones generales de venta



**a) PEDIDOS**

Los pedidos se entienden aceptados con las condiciones indicadas en la confirmación de pedido y no podrán ser anulados ni parcial ni totalmente. En ausencia de confirmación de pedido son válidas las condiciones generales de contrato con el destinatario.

**b) PLAZOS DE ENTREGA**

Transcurren desde la fecha de definición de todos los detalles inherentes al pedido. Pueden ser prorrogados por consecuencia de impedimentos imprevistos como los retrasos sufridos en la entrega de materias primas, daños en las instalaciones, catastrophes naturales, huelgas, cierres, etc. No serán admitidas demandas de indemnización por el incumplimiento de los plazos de entrega.

**c) EXPEDICION DE LA MERCANCIA**

La mercancía se entrega franco establecimiento OMAS y viaja por cuenta y riesgo del Destinatario desde el momento en que es cargada sobre el medio de transporte, también si esta propiedad de OMAS, independientemente de la modalidad de pago del transporte. La mercancía se asegurará solo por orden explícita del destinatario. El embalaje será siempre a cargo del destinatario.

d) DEVOLUCIONES - RECLAMACIONES

No se aceptaran devoluciones de mercancia, bajo ningun concepto, si no han sido autorizadas por OMAS. Las reclamaciones deberan ser adelantadas por escrito dentro de los 8 dias transcurridos a partir de la recepcion de la mercancia y deberan contener la descripcion del defecto encontrado.

e) GARANTIA

La duracion de la garantia es conforme a la normativa vigente. La garantia no cubre defectos debidos a desgaste, falta error en la manutencion, manipulaciones o modificaciones arbitrariamente aportadas, ni a danos causados por el transporte. Le herramientas que OMAS juzgara viciadas por defectos de fabricacion o no correspondientes a la demanda del cliente, podran ser reparadas o sustituidas segun el criterio del fabricante. No se aceptaran demandas de indemnizacion debidas a la entrega de herramientas defectuosas, ni por danos directos ni indirectos, a menos que sea reconocida la culpa grave a cargo del constructor.

f) PRECIOS

Los precios se entienden siempre con el IVA excluido, que serà aplicado con la cuota en vigor en la fecha de la facturacion. Salvo acuerdos particulares señalados en la confirmacion de pedido, seran aplicados los precios de la tarifa en vigor en la fecha de la entrega de la mercancia.

g) PAGOS

Los importes de las facturas se pagaran por entero en los vencimientos establecidos. Todos los gastos suplementarios son a cargo del cliente. Los pagos efectuados por el banco tendran valor desde la fecha de llegada del extracto de la cuenta bancaria. En caso de reclamacion relativa a una parte de la entrega de la mercancia no se admitira retraso en el pago de la parte no conforme de la entrega, ni tampoco en el pago de otra entrega. El incumplimiento de los terminos de pago autoriza a OMAS a suspender eventuales nuevas entregas, y a adeudar los intereses correspondientes y cualquier otra tasa suplementaria. En caso de suspension de las entregas por los motivos de pago indicados, los plazos de entrega previstos se prorrogaran automaticamente. La mercancia serà propiedad de OMAS hasta el pago total de la entrega y de los eventuales gastos suplementarios.

h) COMPETENCIA JURIDICA

Para dirimir eventuales controversias se aplicaran exclusivamente las leyes italianas y el Tribunal competente es solamente el de Ancona.



## Allgemeine Verkaufsbedingungen



a) BESTELLUNGEN

Man hält die Bestellungen für queltig unter den Bedingungen, die in der Auftraghestätigung stehen, und man kann dieselben entweder zum Teil oder vollständig annullieren.

b) LIEFERZEIT

Sie laufen von dem angegebenen Datum der Bestellung, alle Details betreffend. Sie können sich infolge eines unvorhergesehenen Zwischenfalls verschieben, wie ausgefallene Lieferung der Rohstoffe, defekte Anlagen, Naturkatastrophen, Streiks, Aussperrung, u.s.w. Wir akzeptieren keine Schadensersatzansprüche bei Nichteinhaltung der Lieferzeit.

c) ZUSENDUNG DER WARE

Die Ware wird ab Lager OMAS geliefert und auf Risiko, und Gefahr des Empfängers transportiert, und zwar von dem Moment des Beladens auf ein Transportmittel an, auch wenn dieses der Firma OMAS gehört, ohne Rücksicht auf die Zahlungsweise des Transports. Die Zusendung wird auf Wunsch des Empfängers versichert. Die Verpackung geht immer zu Lasten des Empfängers.

d) RÜCKGABE BESCHWERDEN

Wir nehmen keinesfalls eine Rückgabe der Ware an, wenn wir das nicht im Voraus vereinbart haben. Die Beschwerden sollten schriftlich innerhalb 8 Tagen ab Wareneingang erfolgen und die Beschreibung des festgestellten Fehlers enthalten.

e) GARANTIE

Die Dauer der Garantie ist entsprechend der geltenden Rechtsvorschriften. Die Garantie bezieht sich nicht auf Fehler, die durch Verschleiss, unrechtmässigen Gebräch, fehlende oder falsche Instandhaltung, Manipulation oder willkürliche Änderung entstanden sind. Auch Transportschäden werden nicht ersetzt. Die Werkzeuge, deren Defekte von der Firma OMAS anerkannt werden oder der Bestellung des Kunden nicht entsprechen, können nach Urteil des Herstellers repariert oder ersetzt werden. Kein Schadensersatz wird auf Grund der Lieferung von defekten Werkzeuge Akzeptiert, weder auf Grund direkten noch indirekten Schadens, es sei denn, dass eine Schuld zu Lasten des Herstellers anerkannt wird.

f) PREISE

Die Preise verstehen sich immer exklusiv der MwSt, die im Moment des Rechnungsdatums auferlegt ist, es sei denn dass man besondere Vereinbarungen getroffen hat, die durch eine Auftragsbestätigung bewiesen werden müssen. Es wird die Preisliste angewandt, die am Tag der Lieferung der Ware gueltig ist.

g) ZAHLUNGEN

Der Rechnungsbetrag sollte vollständig an dem vereinbarten Termin bezahlt werden. Alle Nebenkosten gehen zu Lasten des Kunden. Die durch Banküberweisung geleisteten Zahlungen sind ab Ankunftsdatum der Ueberweisung ( des Kontoauszugs ) gueltig. Bei Beschwerden in Bezug auf einen Teil der Lieferung wird eine Verspätung in der Zahlung der nicht beanstandeten Lieferung nicht geduldet, noch weniger in der Zahlung einer weiteren Lieferung. Falls die Zalungstermine nicht respektiert werden sollten, behält sich die Firma OMAS das Recht vor, eventuell neue Lieferungen zu unterbrechen und die Zinsen und alle entfallenden Nebenkoster anzurechnen. Im Fall einer Unterbrechung der Lieferungen aus obengenannten Zahlungsgruenden werden die vorausgesehenen Lieferzeiten für diese Aufträge automatisch verschoben. Die Ware bleibt in Besitz der Firma OMAS bis zur vollständigen Zahlung der Lieferung inklusive eventuelle Nebenkosten.

h) STREITFÄLLE

Um eventuelle Streitfälle zu klären, wird nur das italienische Gesetz angewandt und der Gerichtsstand Ist nur in Ancona.

# Lame circolari



Circular saw blades.



Lames circulaires.



Discos de sierra.



Kreissägeblätter.

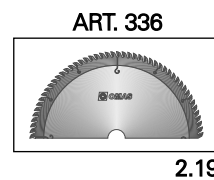
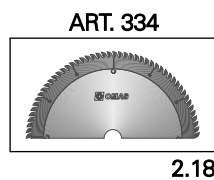
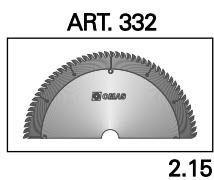
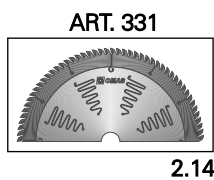
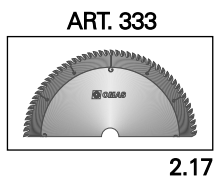
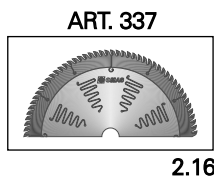
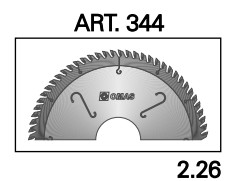
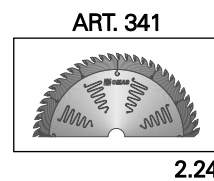
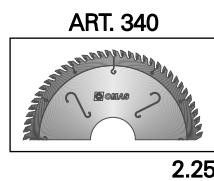
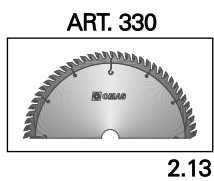
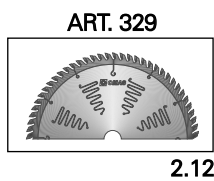
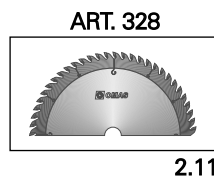
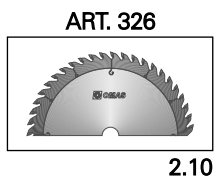
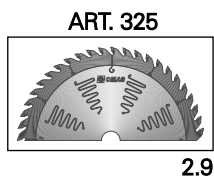
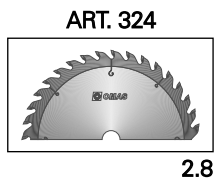
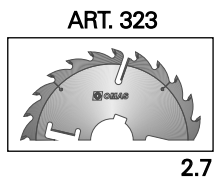
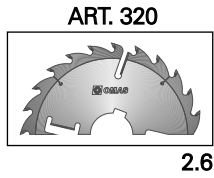
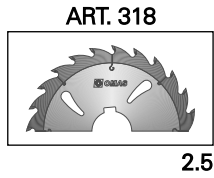
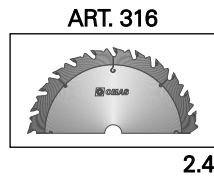
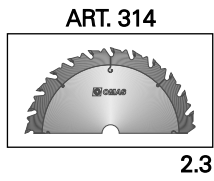
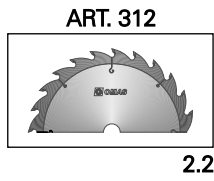



 Circular saw blades.  Lames circulaires.  Discos de sierra.  Kreissägeblätter.



ART. 339

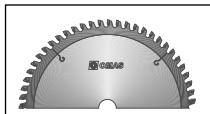

2.21



ART. 342



2.22

ART. 343



2.23



ART. 353



2.30



ART. 350



2.28

ART. 351

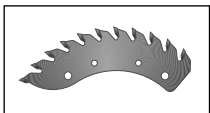

2.29

ART. 352



2.29



ART. 346



2.27



ART. 338



2.20

ART. 357



2.32

ART. 360



2.33



ART. 358

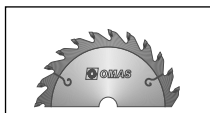

2.31





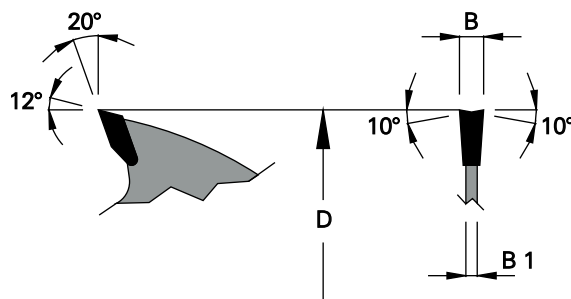
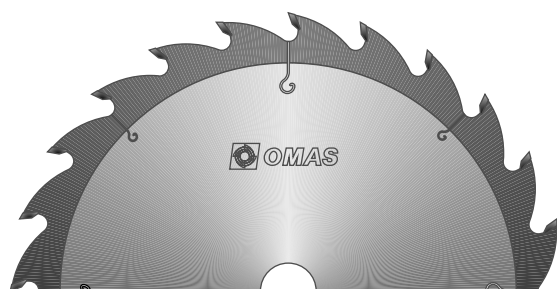

HW

- dente alternato



D	B	B1	d	Z	COD.
250	3.2	2.2	30	20	0312253020
250	3.2	2.2	35	20	0312253520
300	3.2	2.2	30	24	0312303024
300	3.2	2.2	35	24	0312303524
350	3.5	2.5	30	28	0312353028
350	3.5	2.5	35	28	0312353528
400	4	2.8	30	32	0312403032
400	4	2.8	35	32	0312403532
450	4.2	3	30	36	0312453036
450	4.2	3	35	36	0312453536
500	4.2	3	30	40	0312503040
500	4.2	3	35	40	0312503540
550	4.5	3.4	35	48	0312553548
600	4.7	3.5	35	56	0312603556



Rip circular saw blade.  
T.C.T. alternate bevel tooth.



Lame circulaire pour débit en long.  
Denture alternée en carbure.



Disco de sierra para corte longitudinal.  
Diente alterno de metal duro.



Zuschneid-Kreissägeblatt.  
Hartmetallbestückt Wechselzahn.

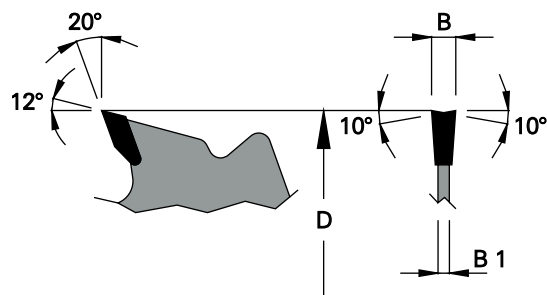

HW

- dente alternato.
- corpo con limitatore di truciolo.

D	B	B 1	d	Z	COD.
250	3.2	2.2	30	20	0314253020
250	3.2	2.2	35	20	0314253520
300	3.2	2.2	30	24	0314303024
300	3.2	2.2	35	24	0314303524
315	3.2	2.2	30	24	0314313024
350	3.5	2.5	30	28	0314353028
350	3.5	2.5	35	28	0314353528
400	4	2.8	30	32	0314403032
400	4	2.8	35	32	0314403532
450	4.2	3	30	36	0314453036
450	4.2	3	35	36	0314453536



Rip circular saw blade.  
T.C.T. alternate bevel tooth.  
Tool body with chip thickness limiter.



Disco de sierra para corte longitudinal.  
Diente alterno de metal duro.  
Cuerpo con limitador del espesor de la viruta.



Lame circulaire pour débit en long.  
Denture alternée en carbure.  
Corps avec limitateur de l'épaisseur des copeaux.



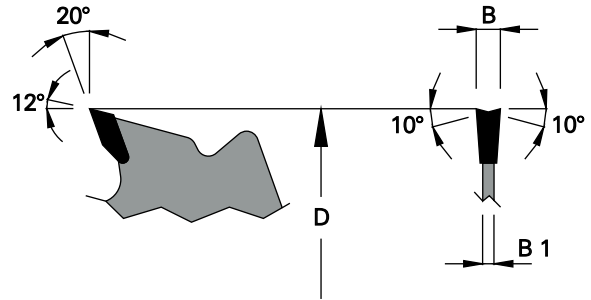

Zuschneid-Kreissägeblatt.  
Hartmetallbestückt Wechselzahn.  
Körper mit Spandickenbegrenzung.

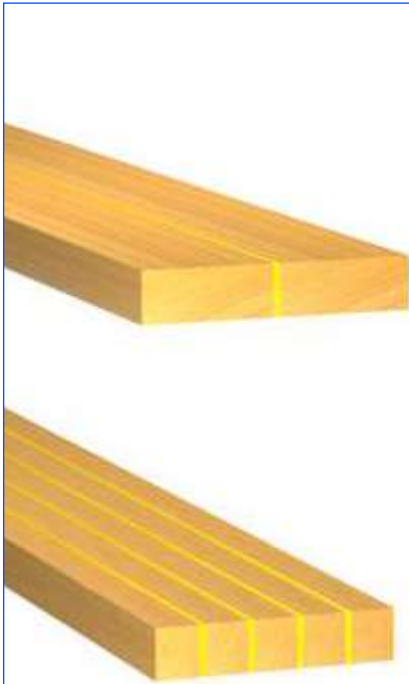

## HW

- dente alternato
- corpo con limitatore di truciolo
- spessore sottile



D	B	B1	d		Z	COD.
200	2	1.4	30		16	0316203016
200	2	1.4	35		16	0316203516
250	2.5	1.8	30		20	0316253020
250	2.5	1.8	35		20	0316253520
250	2.5	1.8	60	2/21x7	20	0316256020
250	2.5	1.8	70	2/21x7	20	0316257020
300	2.5	1.8	30		24	0316303024
300	2.5	1.8	35		24	0316303524
300	2.5	1.8	60	2/21x7	24	0316306024
300	2.5	1.8	70	2/21x7	24	0316307024
350	3	2.2	30		28	0316353028
350	3	2.2	35		28	0316353528
350	3	2.2	60	2/21x7	28	0316356028
350	3	2.2	70	2/21x7	28	0316357028



Rip circular saw blade.  
T.C.T. alternate bevel tooth.  
Tool body with chip thickness limiter.  
Thin cutting width.



Disco de sierra para corte longitudinal.  
Diente alterno de metal duro.  
Cuerpo con limitador del espesor de la viruta.  
Corte delgado.



Lame circulaire pour débit en long.  
Denture alternée en carbure.  
Corps avec limitateur de l'épaisseur des copeaux.  
Mince largeur de coupe.



Zuschneid - Kreissägeblatt.  
Hartmetallbestückt, Wechselzahn.  
Körper mit Spandickenbegrenzung.  
Dünne Schnittbreite.

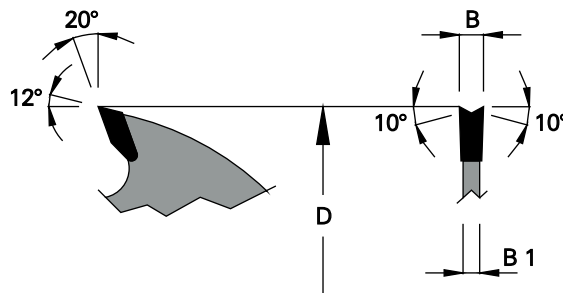

HW

- dente alternato
- corpo con cave di raffreddamento



D	B	B1	d		Z	COD.
200	3.2	2.2	30		16	0318203016
250	3.2	2.2	30		20	0318253020
250	3.2	2.2	60	2/21x7	20	0318256020
250	3.2	2.2	70	2/21x7	20	0318257020
300	3.2	2.2	30		24	0318303024
300	3.2	2.2	60	2/21x7	24	0318306024
300	3.2	2.2	70	2/21x7	24	0318307024
350	3.5	2.5	30		28	0318353028
350	3.5	2.5	60	2/21x7	28	0318356028
350	3.5	2.5	70	2/21x7	28	0318357028
400	4	2.8	30		32	0318403032
400	4	2.8	60	2/21x7	32	0318406032
400	4	2.8	70	2/21x7	32	0318407032



Saw blade for multiple rip saws.  
T.C.T. alternate bevel tooth.  
Tool body with cooling slots.



Disco de sierra para sierras multiples.  
Diente alterno de metal duro.  
Cuerpo con ranuras de refrigeración.



Lame circulaire pour scie multiple.  
Denture alternée en carbure.  
Corps avec éléments de refroidissement.



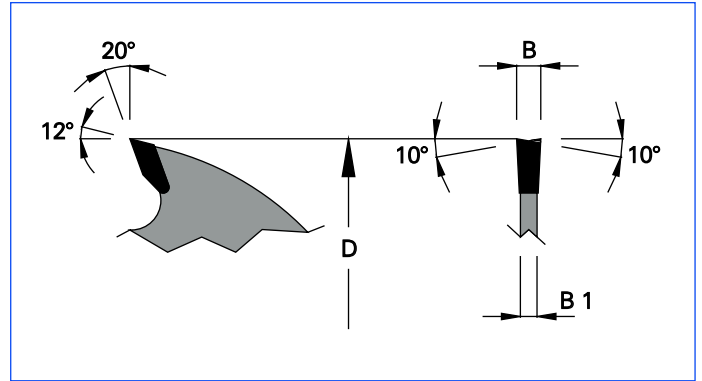
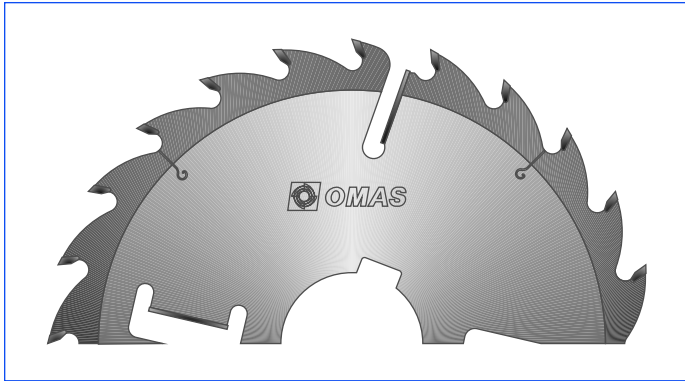

Kreissägeblatt für Mehrblattmaschinen.  
Hartmetallbestückt, Wechselzahn.  
Körper mit Kühllöchern.

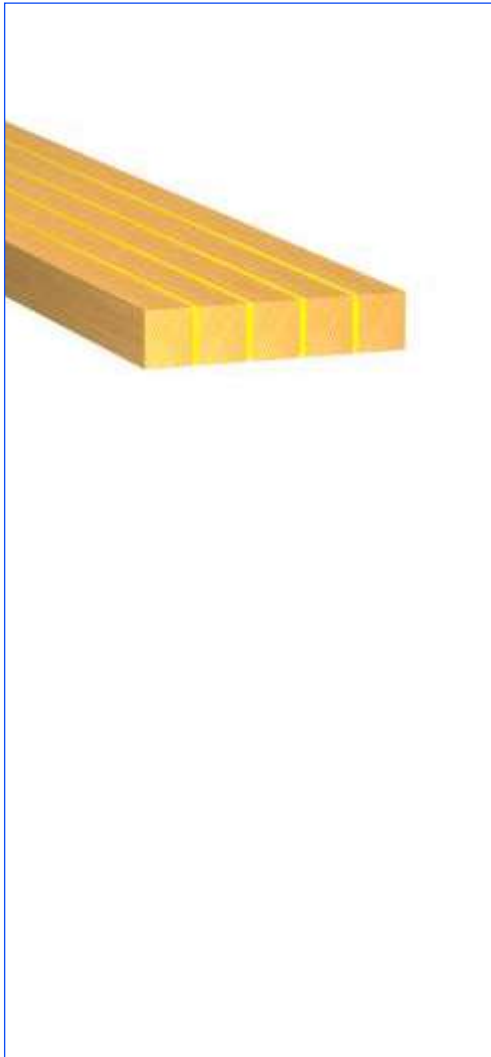

HW

- dente alternato
- con rasanti



D	B	B 1	d		Z	V	COD.
250	3.2	2.2	30		20	2	0320253020
250	3.2	2.2	60	2/21x7	20	2	0320256020
250	3.2	2.2	70	2/21x7	20	2	0320257020
250	3.2	2.2	80	2/13x6	20	2	0320258020
280	3.2	2.2	80	2/13x6	20	4	0320288020
300	3.2	2.2	30		24	4	0320303024
300	3.2	2.2	60	2/21x7	24	4	0320306024
300	3.2	2.2	70	2/21x7	24	4	0320307024
300	3.2	2.2	80	2/13x6	24	4	0320308024
320	3.2	2.2	70	2/21x7	24	4	0320327024
320	3.2	2.2	80	2/13x6	24	4	0320328024
350	3.5	2.5	30		28	4	0320353028
350	3.5	2.5	60	2/21x7	28	4	0320356028
350	3.5	2.5	70	2/21x7	28	4	0320357028
350	3.5	2.5	80	2/13x6	28	4	0320358028
400	4	2.8	30		32	6	0320403032
400	4	2.8	60	2/21x7	32	6	0320406032
400	4	2.8	70	2/21x7	32	6	0320407032
400	4	2.8	80	2/13x6	32	6	0320408032



Saw blade for multiple ripsaws.  
T.C.T. alternate bevel tooth.  
With T.C.T. wiper slots.



Disco de sierra para Sierras multiples.  
Diente altemo de metal duro.  
Con placas separadoras de metal duro.



Lame circulaire pour scie multiple.  
Denture alternée en carbure.  
Avec éléments de guidage en carbure.



Kreissägeblatt für Mehrblattmaschinen.  
Hartmetallbestückt, Wechselzahn.  
Mit HM - Räumern.

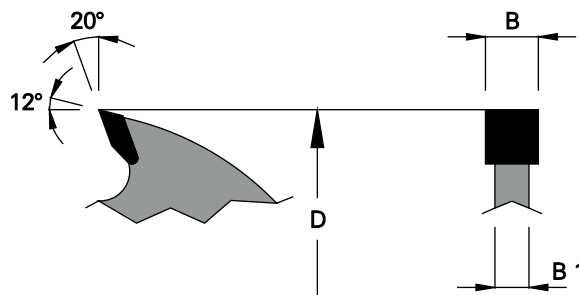
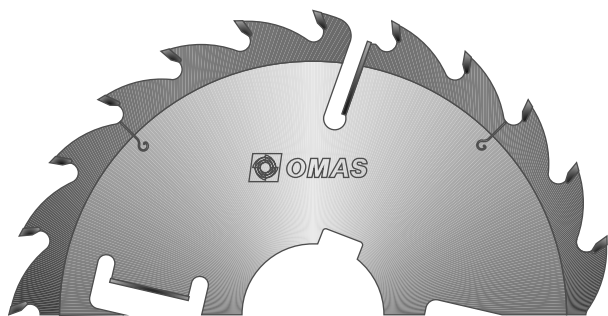

## HW

- dente piano
- con rasanti
- utilizzabile come lama laterale del gruppo ( lama di spalla )



D	B	B1	d		Z	V	COD.
250	7	4.5	30		20	2	0323253020
250	7	4.5	60	2/21x7	20	2	0323256020
250	7	4.5	70	2/21x7	20	2	0323257020
250	7	4.5	80	2/13x6	20	2	0323258020
280	7	4.5	80	2/13x6	20	4	0323288020
300	7	4.5	30		24	4	0323303024
300	7	4.5	60	2/21x7	24	4	0323306024
300	7	4.5	70	2/21x7	24	4	0323307024
300	7	4.5	80	2/13x6	24	4	0323308024
320	7	4.5	70	2/21x7	24	4	0323327024
320	7	4.5	80	2/13x6	24	4	0323328024
350	7	4.5	30		28	4	0323353028
350	7	4.5	60	2/21x7	28	4	0323356028
350	7	4.5	70	2/21x7	28	4	0323357028
350	7	4.5	80	2/13x6	28	4	0323358028
400	7	4.5	30		32	4	0323403032
400	7	4.5	60	2/21x7	32	4	0323406032
400	7	4.5	70	2/21x7	32	4	0323407032
400	7	4.5	80	2/13x6	32	4	0323408032



Saw blade for multiple rip saws.  
T.C.T. flat tooth.  
With T.C.T. wiper slots.  
Suitable as side saw of the set on multiple rip saws.



Disco de sierra para Sierras multiples.  
Diente recto de metal duro.  
Con placas separadoras de metal duro.  
Indicada como sierra lateral del juego para sierras multiple.



Lame circulaire pour scie multiple.  
Denture plate en carbure.  
Avec éléments de guidage en carbure.  
Utilisable comme lame extérieure du groupe sur scie multiple.



Kreissägeblatt für Mehrblattmaschinen.  
Hartmetallbestückt Flachzahn.  
Mit HM - Räumern.  
Benutzbar als seitlicher Blatt der Gruppe für Mehrblattmaschinen.

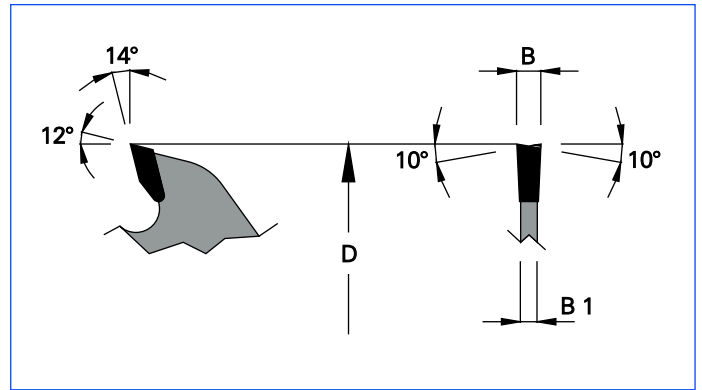
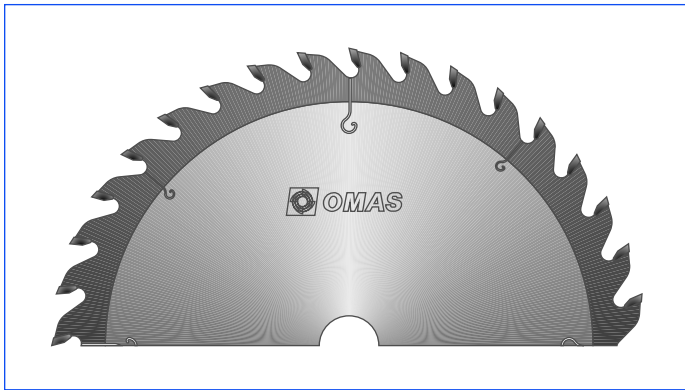

HW

- dente alternato

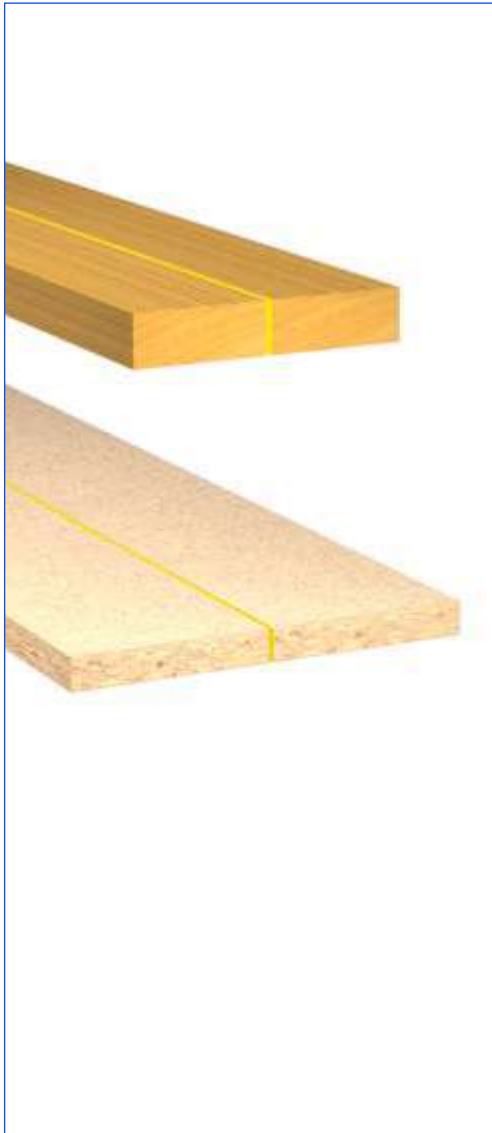

D	B	B 1	d	Z	COD.
180	3.2	2.2	30	20	0324183020
180	3.2	2.2	35	20	0324183520
200	3.2	2.2	30	24	0324203024
250	3.2	2.2	30	28	0324253028
300	3.2	2.2	30	36	0324303036
300	3.2	2.2	35	36	0324303536
350	3.5	2.5	30	44	0324353044
350	3.5	2.5	35	44	0324353544
400	4	2.8	30	48	0324403048
400	4	2.8	35	48	0324403548



Universal saw blade.  
T.C.T. alternate bevel tooth.



Disco de sierra universal.  
Diente alternativo de metal duro.



Lame circulaire universelle.  
Denture alternée en carbure.



Universal - Kreissägeblatt.  
Hartmetallbestückt, Wechselzahn.

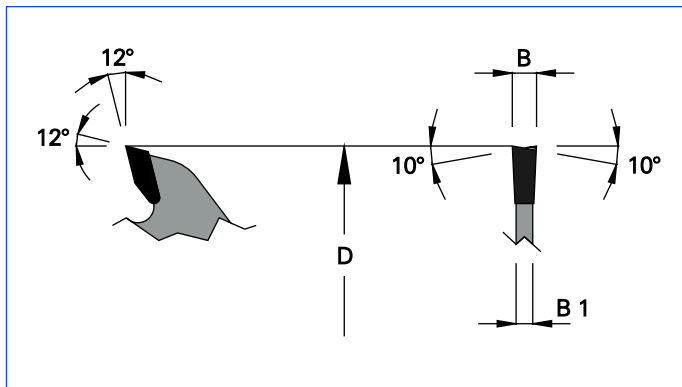
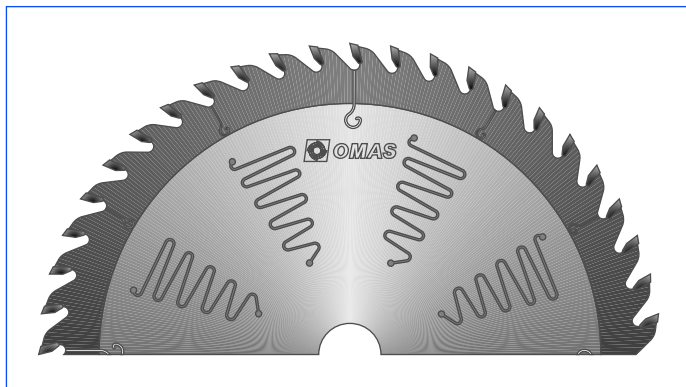

HW

- dente alternato
- corpo silenziato

D	B	B1	d	Z	COD.
250	3.2	2.2	30	40	0325253040
250	3.2	2.2	35	40	0325253540
300	3.2	2.2	30	48	0325303048
300	3.2	2.2	35	48	0325303548
350	3.5	2.5	30	56	0325353056
350	3.5	2.5	35	56	0325353556

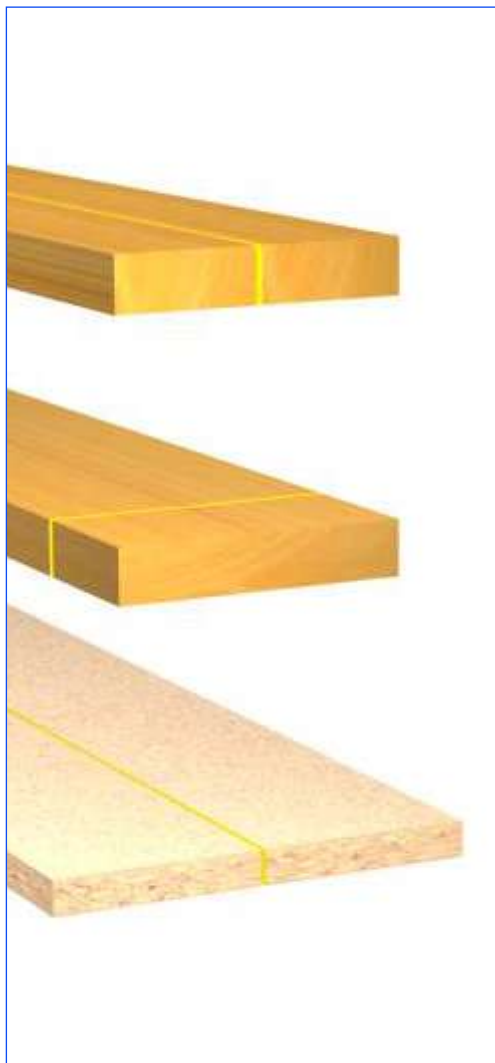

Noise reduction universal saw blade.  
T.C.T. alternate bevel tooth.  
Tool body with microleaves.



Disco de sierra universal silenciado.  
Diente alterno de metal duro.  
Cuerpo con microfisuras.



Lame circulaire universelle à bruit réduit.  
Denture alternée en carbure.  
Corps avec fentes micrométriques.



Geräuscharm Universal - Kreissägeblatt.  
Hartmetallbestückt Wechselzahn.  
Körper mit Mikroschlitzten.



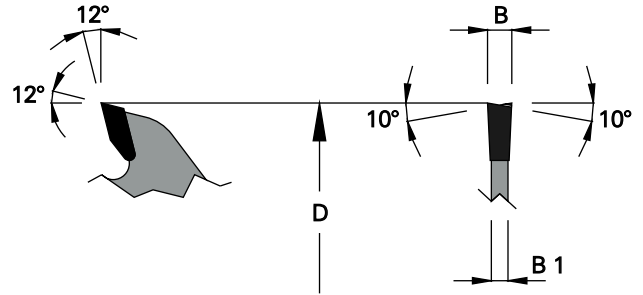
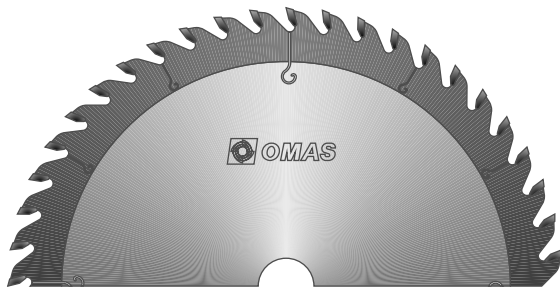

HW

- dente alternato

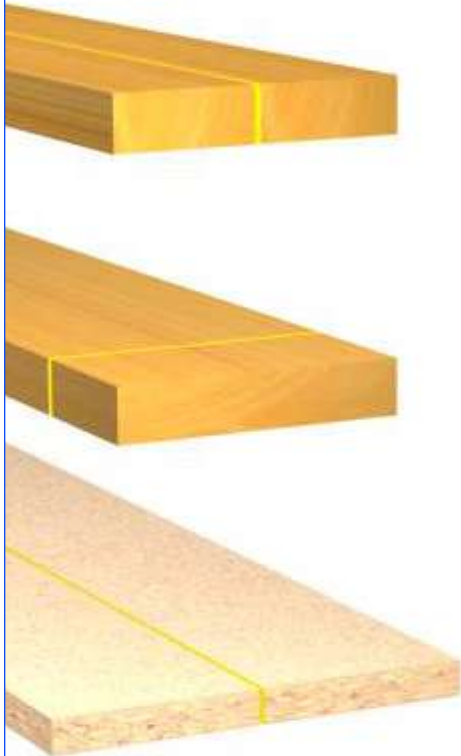

D	B	B1	d	Z	COD.
150	3.2	2.2	20	24	0326152024
150	3.2	2.2	30	24	0326153024
150	3.2	2.2	35	24	0326153524
180	3.2	2.2	30	28	0326183028
180	3.2	2.2	35	28	0326183528
200	3.2	2.2	30	32	0326203032
200	3.2	2.2	35	32	0326203532
225	3.2	2.2	30	36	0326223036
225	3.2	2.2	35	36	0326223536
250	3.2	2.2	30	40	0326253040
250	3.2	2.2	35	40	0326253540
300	3.2	2.2	30	48	0326303048
300	3.2	2.2	35	48	0326303548
315	3.2	2.2	30	48	0326313048
350	3.5	2.5	30	56	0326353056
350	3.5	2.5	35	56	0326353556
400	4	2.8	30	64	0326403064
400	4	2.8	35	64	0326403564
450	4.2	3	30	72	0326453072
450	4.2	3	35	72	0326453572
500	4.2	3	30	80	0326503080
500	4.2	3	35	80	0326503580
550	4.5	3.4	35	96	0326553596
600	4.6	3.5	35	108	0326603510



Universal saw blade.  
T.C.T. alternate bevel tooth.



Disco de sierra universal.  
Diente alternativo de metal duro.



Lame circulaire universelle.  
Denture alternée en carbure.



Universal - Kreissägeblatt.  
Hartmetallbestückt Wechselzahn.

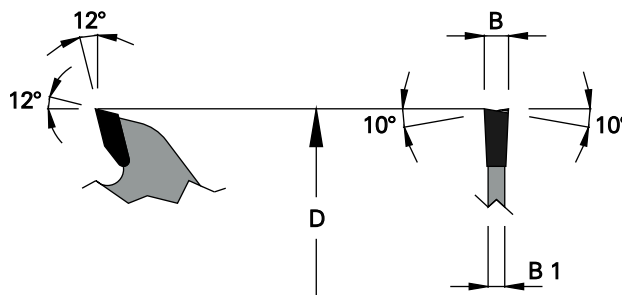
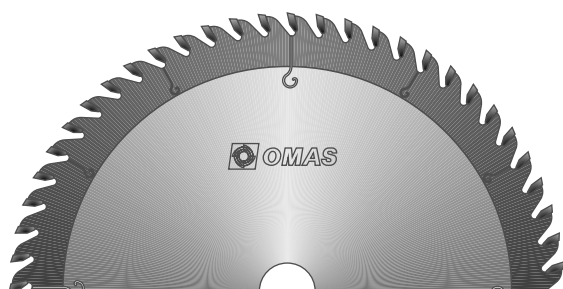



HW

- dente alternato

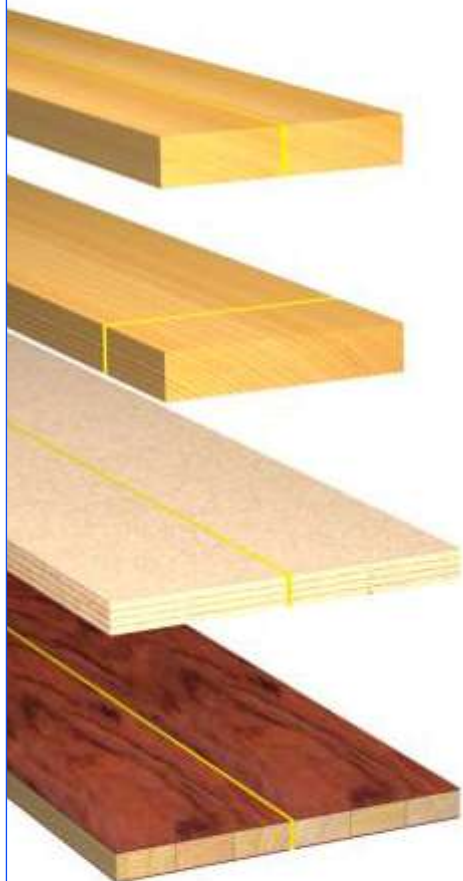
D	B	B1	d	Z	COD.
180	3.2	2.2	30	36	0328183036
180	3.2	2.2	35	36	0328183536
200	3.2	2.2	30	40	0328203040
200	3.2	2.2	35	40	0328203540
250	3.2	2.2	30	48	0328253048
250	3.2	2.2	35	48	0328253548
300	3.2	2.2	30	60	0328303060
300	3.2	2.2	35	60	0328303560
350	3.5	2.5	30	72	0328353072
350	3.5	2.5	35	72	0328353572
400	4	2.8	30	80	0328403080
400	4	2.8	35	80	0328403580



 Universal saw blade.  
T.C.T. alternate bevel tooth.

 lame circulaire universelle.  
Denture alternée en carbure.

 Disco de sierra universal.  
Diente alterno de metal duro.

 Universal - Kreissägeblatt.  
Hartmetallbestückt Wechselzahn.

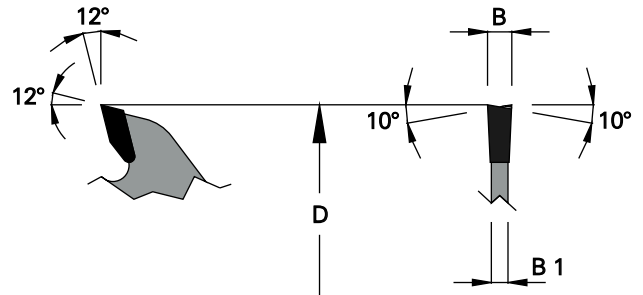
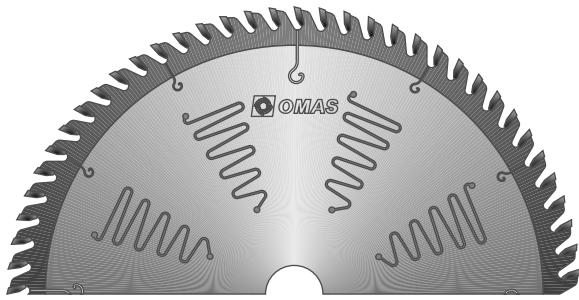

HW

- dente alternato
- corpo silenziato

D	B	B 1	d	Z	COD.
250	3.2	2.2	30	60	0329253060
250	3.2	2.2	35	60	0329253560
300	3.2	2.2	30	72	0329303072
300	3.2	2.2	35	72	0329303572
350	3.5	2.5	30	84	0329353084
350	3.5	2.5	35	84	0329353584



Noise reduction universal saw blade.  
T.C.T. alternate bevel tooth.  
Tool body with microleaves.



Disco de sierra universal silenciado.  
Diente altemo de metal duro.  
Cuerpo con microfisuras.



Lame circulaire universelle à bruit réduit.  
Denture alternée en carbure.  
Corps avec fentes micrométriques.



Geräuscharm Universal - Kreissägeblatt.  
Hartmetallbestückt Wechselzahn.  
Körper mit Mikroschlitzten.

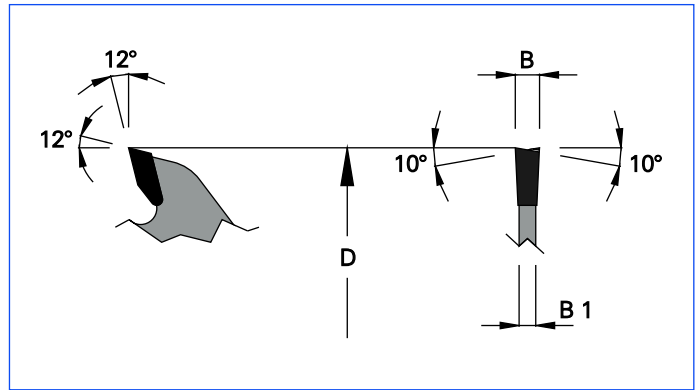
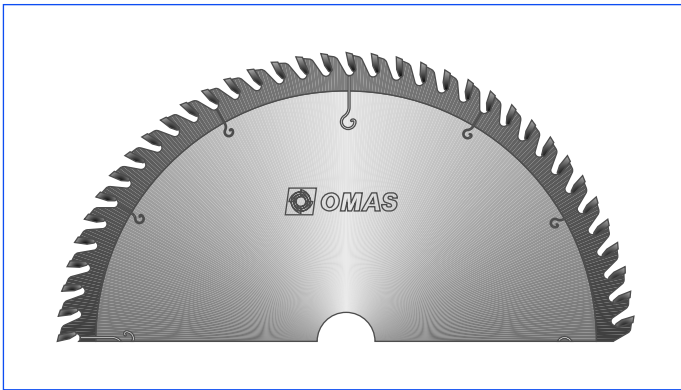



HW

- dente alternato



D	B	B1	d	Z	COD.
100	3.2	2.2	20	24	0330102024
100	3.2	2.2	30	24	0330103024
100	3.2	2.2	35	24	0330103524
110	3.2	2.2	20	24	0330112024
125	3.2	2.2	20	30	0330122030
125	3.2	2.2	30	30	0330123030
150	3.2	2.2	30	36	0330153036
150	3.2	2.2	35	36	0330153536
180	3.2	2.2	30	44	0330183044
180	3.2	2.2	35	44	0330183544
200	3.2	2.2	30	48	0330203048
200	3.2	2.2	35	48	0330203548
225	3.2	2.2	30	56	0330223056
250	3.2	2.2	30	60	0330253060
250	3.2	2.2	35	60	0330253560
300	3.2	2.2	30	72	0330303072
300	3.2	2.2	35	72	0330303572
315	3.2	2.2	30	72	0330313072
350	3.5	2.5	30	84	0330353084
350	3.5	2.5	35	84	0330353584
400	4	2.8	30	96	0330403096
400	4	2.8	35	96	0330403596
450	4.2	3	30	108	0330453010
450	4.2	3	35	108	0330453510
500	4.2	3	30	128	0330503012
500	4.2	3	35	128	0330503512

 Universal saw blade.  
T.C.T. alternate bevel tooth.

 Disco de sierra universal.  
Diente alterno de metal duro.

 lame circulaire universelle.  
Denture alternée en carbure.

 Universal - Kreissägeblatt.  
Hartmetallbestückt Wechselzahn.

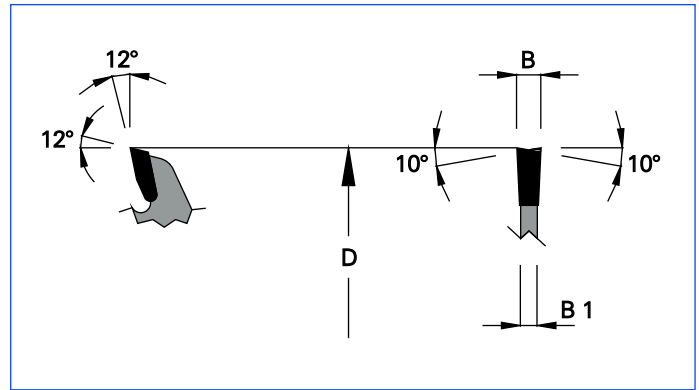
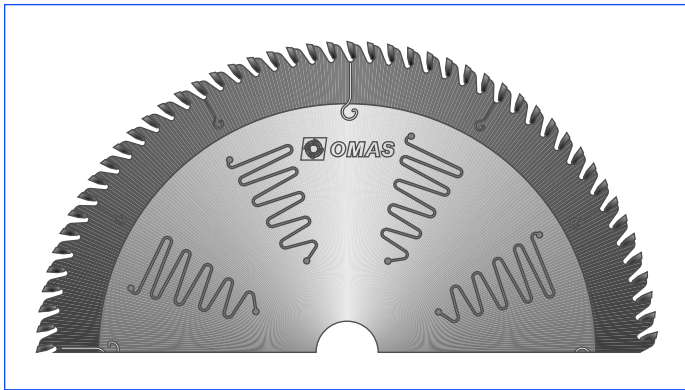

HW

- dente alternato
- corpo silenziato

D	B	B 1	d	Z	COD.
250	3.2	2.2	30	80	0331253080
250	3.2	2.2	35	80	0331253580
300	3.2	2.2	30	96	0331303096
300	3.2	2.2	35	96	0331303596
350	3.5	2.5	30	108	0331353010
350	3.5	2.5	35	108	0331353510



Noise reduction universal saw blade.  
T.C.T. alternate bevel tooth.  
Tool body with microleaves.



Disco de sierra universal silenciado.  
Diente altemo de metal duro.  
Cuerpo con microfisuras.



Lame circulaire universelle à bruit réduit.  
Denture alternée en carbure.  
Corps avec fentes micrométriques.



Geräuscharm Universal - Kreissägeblatt.  
Hartmetallbestückt Wechselzahn.  
Körper mit Mikroschlitzten.

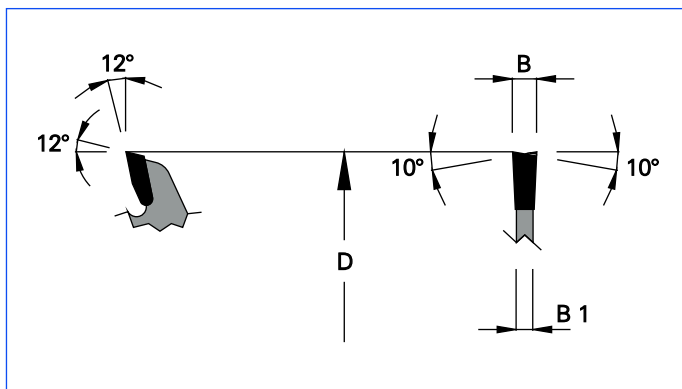
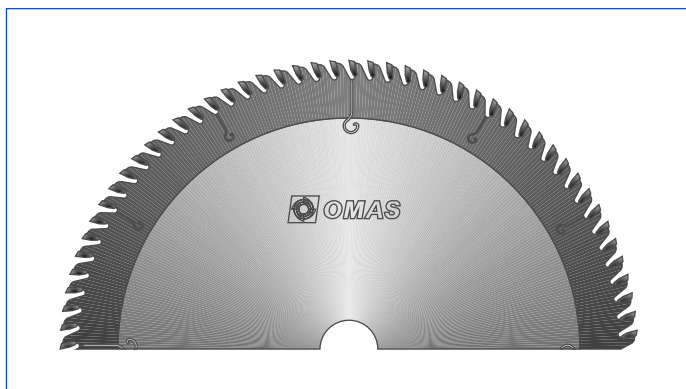

HW

- dente alternato



D	B	B1	d	Z	COD.
150	3.2	2.2	30	48	0332153048
180	3.2	2.2	30	56	0332183056
200	3.2	2.2	30	64	0332203064
200	3.2	2.2	35	64	0332203564
225	3.2	2.2	30	72	0332223072
250	3.2	2.2	20	80	0332252080
250	3.2	2.2	30	80	0332253080
250	3.2	2.2	35	80	0332253580
300	3.2	2.2	30	96	0332303096
300	3.2	2.2	35	96	0332303596
330	3.5	2.5	20	96	0332332096
330	3.5	2.5	30	96	0332333096
350	3.5	2.5	30	108	0332353010
350	3.5	2.5	35	108	0332353510
400	4	2.8	30	128	0332403012
400	4	2.8	35	128	0332403512



Universal saw blade.  
T.C.T. alternate bevel tooth.



Disco de sierra universal.  
Diente alternativo de metal duro.



Lame circulaire universelle.  
Denture alternée en carbure.

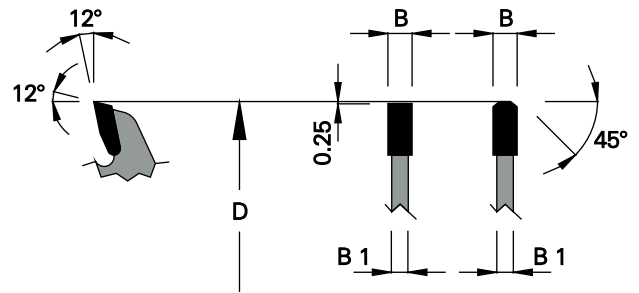
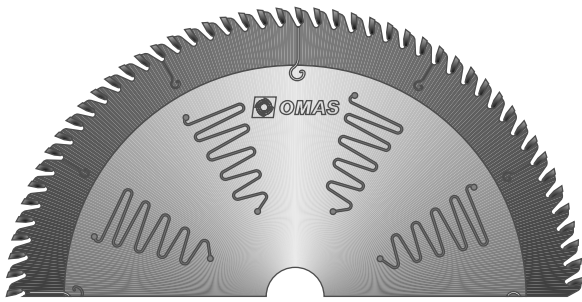

Universal - Kreissägeblatt.  
Hartmetallbestückt Wechselzahn.

**HW**

- dente piano + trapezoidale
- corpo silenziato

D	B	B 1	d	Z	COD.
250	3.2	2.2	30	80	0337253080
300	3.2	2.2	30	96	0337303096
350	3.5	2.5	30	108	0337353010
350	3.5	2.5	35	108	0337353510

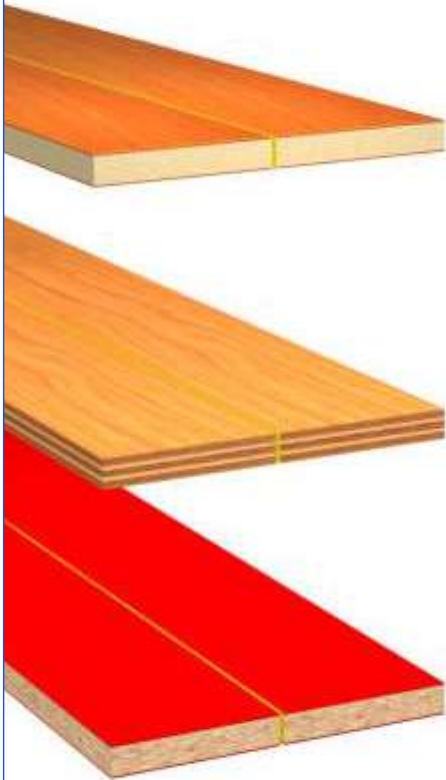

Noise reduction universal saw blade.  
T.C.T. flat + triple-chip tooth.  
Tool body with microleaves.



Lame circulaire universelle à bruit réduit.  
Denture plate + trapézoïdale en carbure.  
Corps avec fentes micrométriques.



Disco de sierra universal silenciado.  
Diente recto + trapecial de metal duro.  
Cuerpo con microfisuras.



Geräuscharm Universal - Kreissägeblatt.  
Hartmetallbestückt Trapez - und Flachzahn.  
Körper mit Mikroschlitzten.

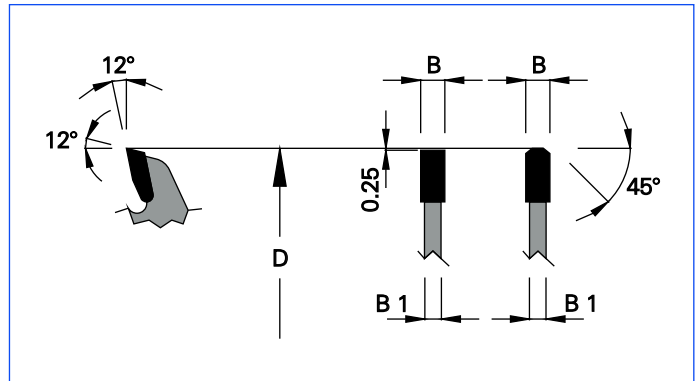

HW

– dente piano + trapezoidale

D	B	B1	d	Z	COD.
200	3.2	2.2	30	64	0333203064
250	3.2	2.2	30	80	0333253080
300	3.2	2.2	30	96	0333303096
350	3.5	2.5	30	108	0333353010
350	3.5	2.5	35	108	0333353510



Universal saw blade.  
T.C.T flat + triple-chip tooth.



Disco de sierra universal.  
Diente recto + trapecial de metal duro.



Lame circulaire universelle.  
Denture plate + trapézoïdale en carbure.



Universal - Kreissägeblatt.  
Hartmetallbestückt Trapez- und Flachzahn.



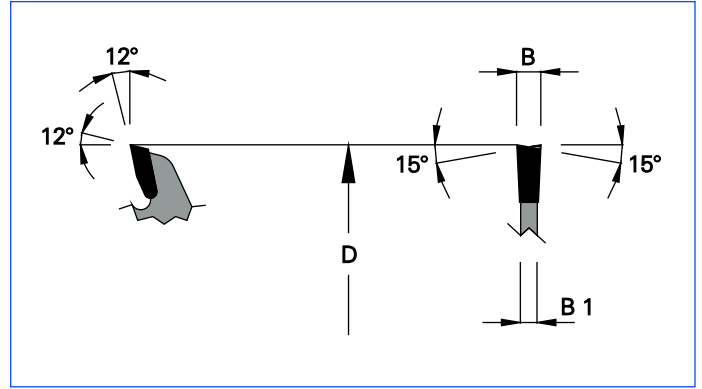
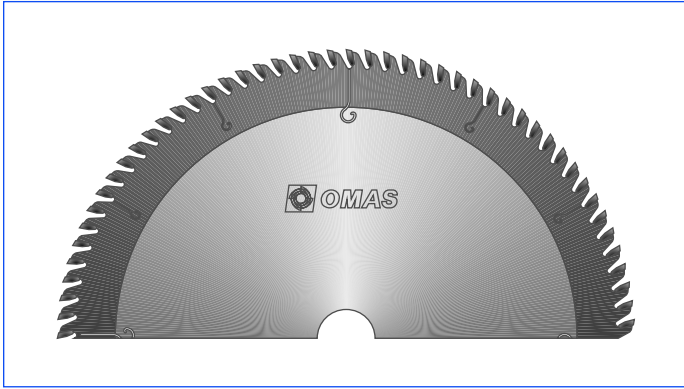

**HW**

– dente alternato

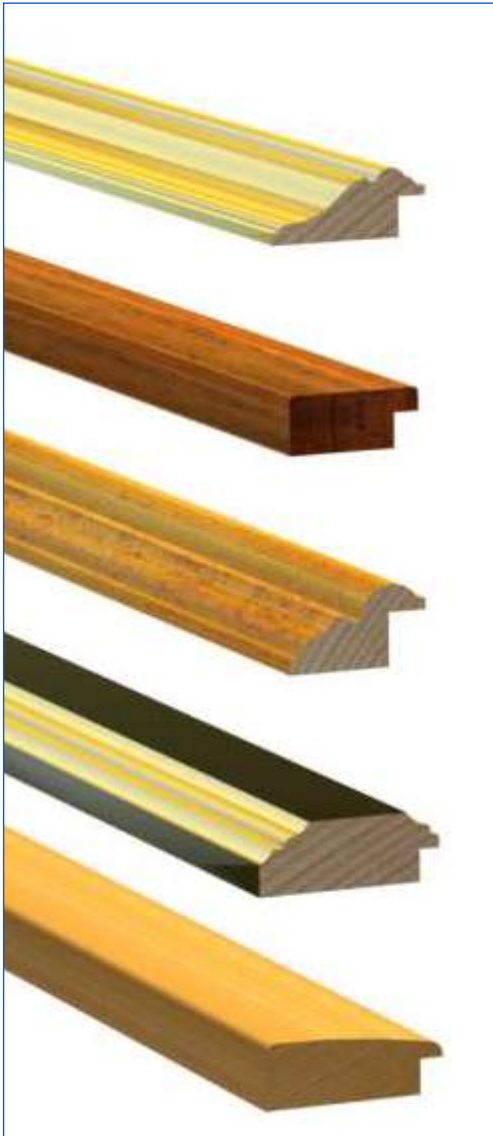

D	B	B 1	d	Z	COD.
200	3	2.5	20	70	0334202070
200	3	2.5	30	70	0334203070
250	3.1	2.5	20	90	0334252090
250	3.1	2.5	30	90	0334253090
300	3.2	2.6	30	100	0334303010
350	3.3	2.8	30	120	0334353012

 Saw blade for mitre sawing machines.  
T.C.T alternate bevel tooth.

 Disco de sierra para cortar ingletes.  
Diente alternativo de metal duro.

 Lame circulaire pour coupes d'onglet.  
Denture alternée en carbure.

 Kreissägeblatt für Gehrungssägen.  
Hartmetallbestückt Wechselzahn.

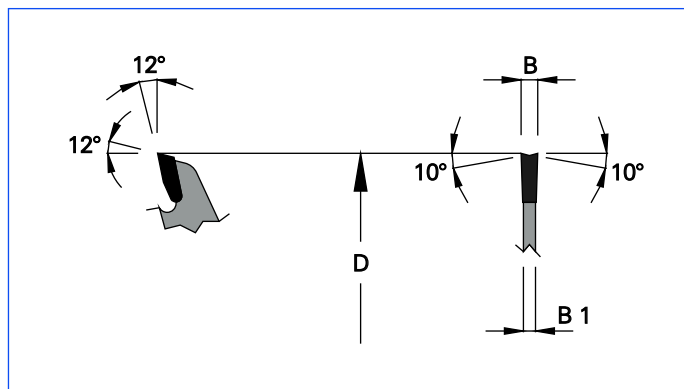
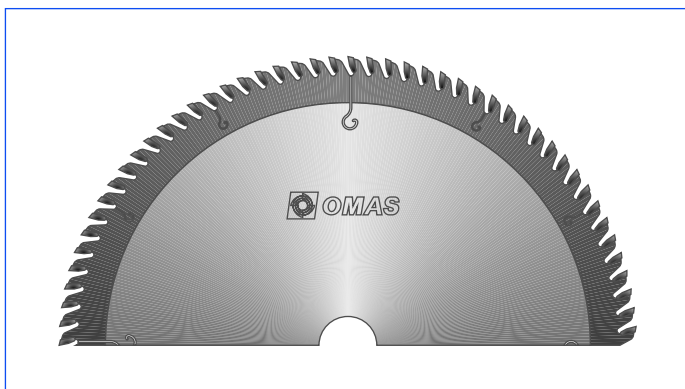

HW

– dente alternato



D	B	B1	d	Z	COD.
150	2.5	1.8	30	36	0336153036
150	2.5	1.8	35	36	0336153536
180	2.5	1.8	30	44	0336183044
200	2.5	1.8	30	48	0336203048
200	2.5	1.8	35	48	0336203548
250	2.5	1.8	20	60	0336252060
250	2.5	1.8	30	60	0336253060
250	2.5	1.8	20	80	0336252080
250	2.5	1.8	30	80	0336253080
280	2.8	1.8	30	64	0336283064
300	2.5	1.8	30	72	0336303072
300	2.5	1.8	35	72	0336303572
300	2.5	1.8	30	96	0336303096
300	2.5	1.8	35	96	0336303596



Saw blade with thin cutting width.  
T.C.T. alternate bevel tooth.



Lame circulaire mince.  
Denture alternée en carbure.



Disco de sierra con ancho de corte reducido.  
Diente alterno de metal duro.



Kreissägeblatt mit dünne Schnittbreite.  
Hartmetallbestückt, Wechselzhan.

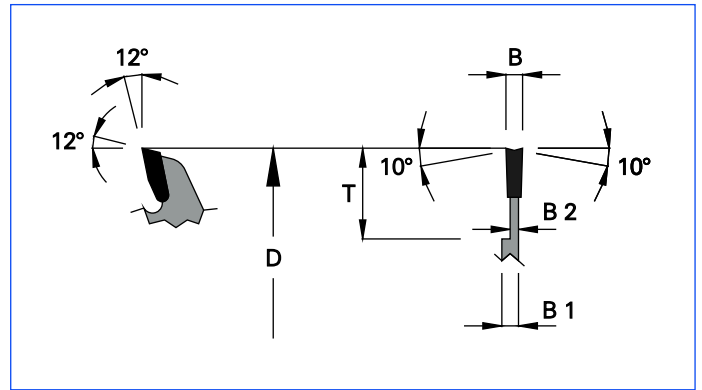
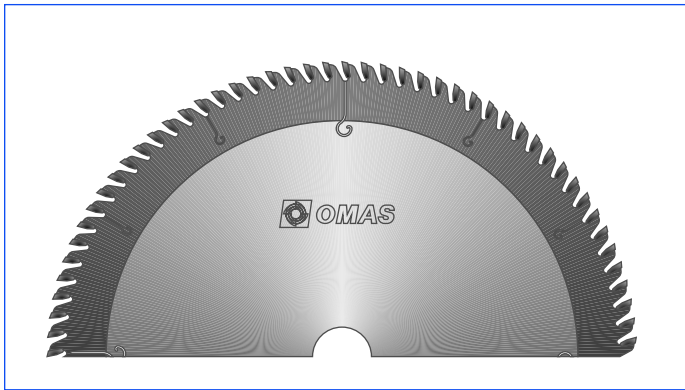

HW

- dente alternato
- corpo rinforzato
- profondità di taglio limitata

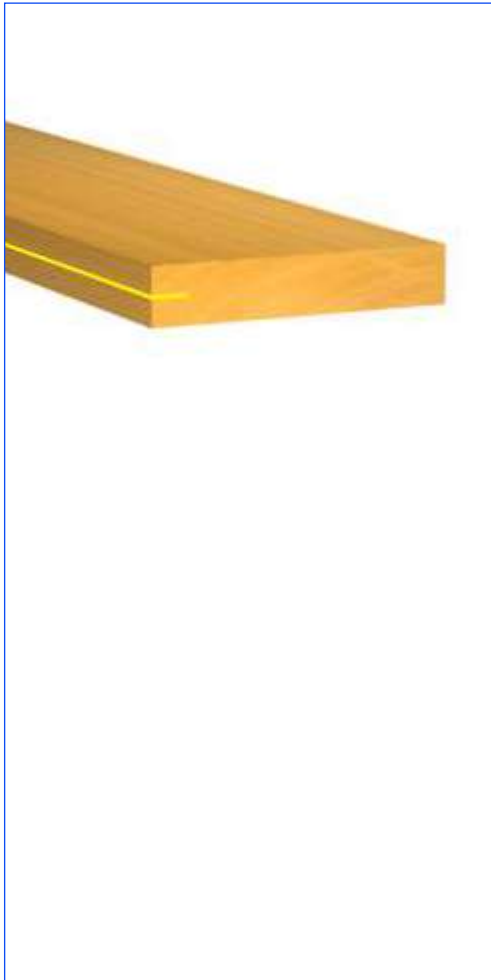

D	B	B1	B2	T	d	Z	COD.
150	1.5	2.2	1.1	25	20	48	0338152048
150	1.5	2.2	1.1	25	30	48	0338153048
150	1.5	2.2	1.1	25	35	48	0338153548
200	1.5	2.2	1.1	35	30	64	0338203064
200	1.5	2.2	1.1	35	35	64	0338203564
250	1.6	2.2	1.2	45	30	80	0338253080
250	1.6	2.2	1.2	45	35	80	0338253580
300	1.7	2.2	1.3	50	30	96	0338303096
300	1.7	2.2	1.3	50	35	96	0338303596



Saw blade with extra - thin cutting width.  
T.C.T. alternate bevel tooth.  
Bossed tool body.  
Limited cutting height.



Disco de sierra con ancho de corte extra-sutil.  
Diente alterno de metal duro.  
Cuerpo rebajado.  
Altura de corte limitada.



Lame circulaire extra-mince.  
Denture alternée en carbure.  
Corps renforcé.  
Hauteur de coupe limitée.



Kreissägeblatt mit extra - dünne Schnittbreite.  
Hartmetallbestückt, Wechselzahn.  
Abgesetzter Tragkörper.  
Schnitthöhe begrenzt.

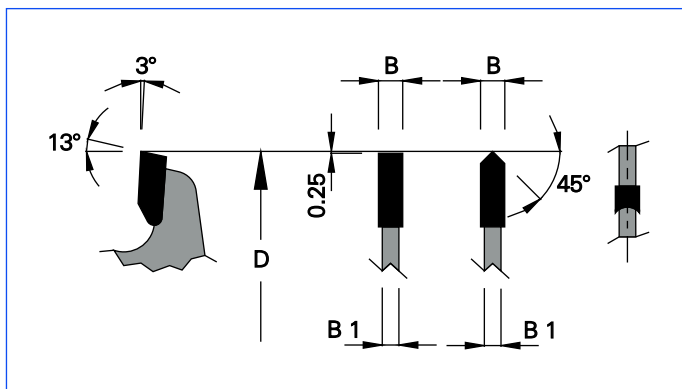
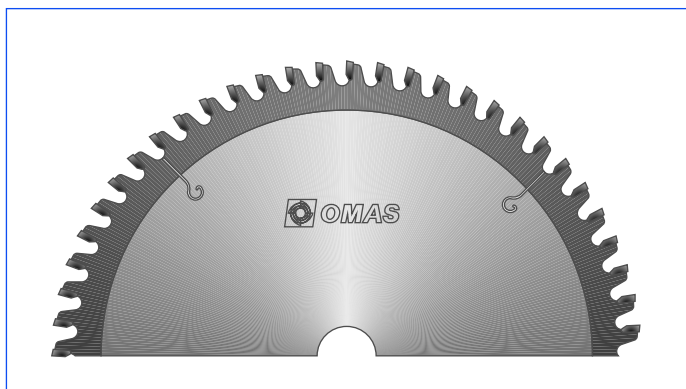

HW

- dente negativo a punta + piano sul dorso
- con profilo concavo sul petto

D	B	B 1	d	Z	COD.
250	3.2	2.2	30	48	0339253048
303	3.2	2.2	30	60	0339303060
350	3.5	2.5	30	72	0339353072

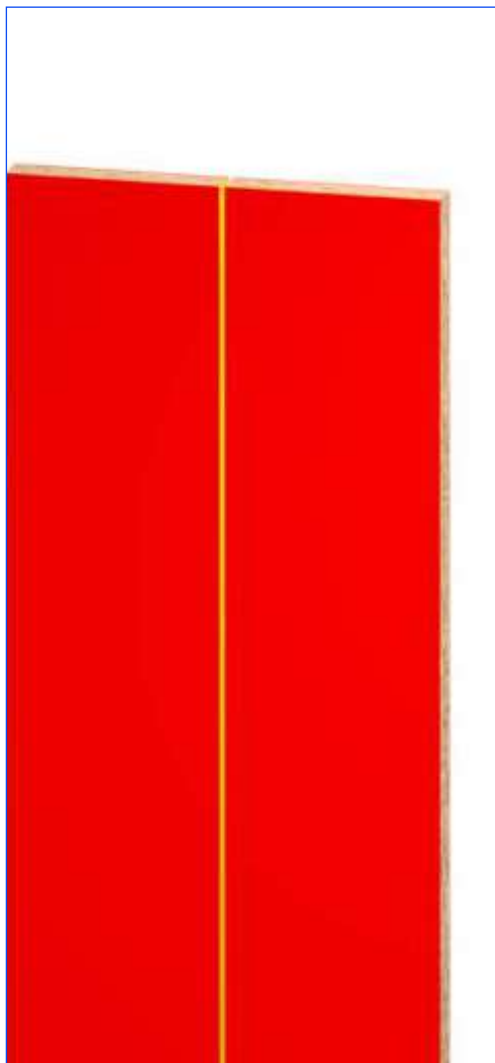

Panel saw blade.  
T.C.T. negative flat + V inverted tooth, with hollow ground face.



Lame circulaire pour panneaux.  
Denture negative plate + toite en carbure, face d'attaque avec profil concave.



Disco de sierra para tableros.  
Diente negativo recto + V perfil de metal duro, superficie de ataque con perfil concavo.



Platten -Kreissägeblatt.  
Hartmetallbestückt mit negativem Spanwinkel, Dach - und Flachzahn mit Holzhahn.

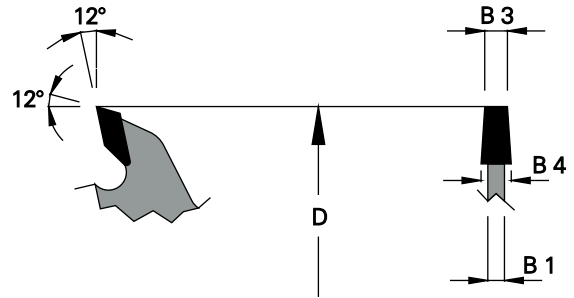

HW

– dente a profilo conico



D	B3	B4	B1		d	Z	COD.
80	3.1	4.2	2.2		20	12	0342082031
90	3.1	4.2	2.2		22	12	0342092212
90	3.1	4.2	2.2		30	12	0342093031
100	3.1	4.2	2.2		20	24	0342102031
110	3.1	4.2	2.2		20	24	0342112031
115	3.1	4.2	2.2		20	24	0342152031
120	3.1	4.2	2.2		20	24	0342202031
120	3.4	4.6	2.2		20	24	0342202034
125	3.1	4.2	2.2		20	24	0342252031
125	3.4	4.6	2.2		20	24	0342252034
125	3.1	4.2	2.2		22	24	0342252231
125	3.1	4.2	2.2		30	24	0342253031
125	3.1	4.2	2.2		45	24	0342254531
125	3.4	4.6	2.2		45	24	0342254534
125	4.3	5.5	3.0		20	24	0342252043
125	4.3	5.5	3.0		22	24	0342252243
125	4.3	5.5	3.0		30	24	0342253043
125	4.3	5.5	3.0		45	24	0342254543
150	3.1	4.2	2.5		20	36	0342502031
150	3.1	4.2	2.5		30	36	0342503031
150	3.4	4.6	2.5		30	36	0342503034
150	4.3	5.5	3.0		20	36	0342502043
150	4.3	5.5	3.0		30	36	0342503043
150	4.3	5.5	3.0		50	36	0342505043
160	4.3	5.5	3.0	3x7/66	55	36	0342605543
180	4.3	5.5	3.0		45	36	0342804543
200	4.3	5.5	3.0		22	36	0342702243
200	4.3	5.5	3.0	2x9/110	65	36	0342706543



Conical scoring blade.  
T.C.T. conical tooth.



Sierra incisora cónica.  
Diente cónico de metal duro.



Lame incisiveuse conique.  
Denture conique en carbure.



Konische Ritz - Kreissägeblatt.  
Hartmetallbestückt Konischzahn.

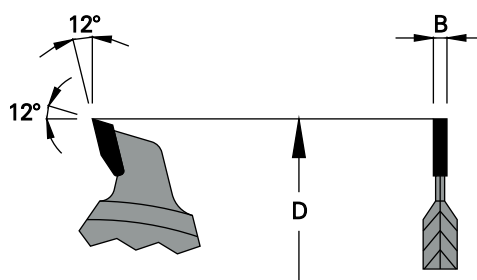



HW

– dente piano

D	B	d	Z	COD.
80	2.8-3.6	20	10+10	0343082010
100	2.8-3.6	20	10+10	0343102010
100	2.8-3.6	22	10+10	0343102210
120	2.8-3.6	20	12+12	0343122012
120	2.8-3.6	22	12+12	0343122212
125	2.8-3.6	20	12+12	0343132012
125	2.8-3.6	30	12+12	0343133012



 Scoring blade adjustable by spacers.  
T.C.T. flat tooth.

 Lame inciseuse extensible par bagues.  
Denture plate en carbure.

 Sierra incisora ajustable con anillos.  
Diente recto de metal duro.

 Verstellbar Ritz - Kreissägeblatt.  
Hartmetallbestückt Flachzahn.

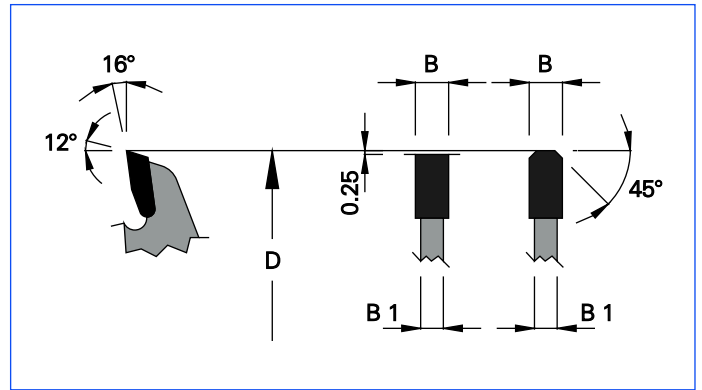
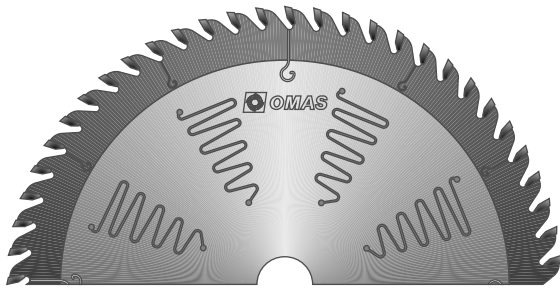
**HW**

- dente piano + trapezoidale
- corpo silenziato



D	B	B 1	d	Z	COD.
300	4.4	2.8	30	60	0341303060
300	4.4	2.8	30	72	0341303072
300	4.4	2.8	35	72	0341303572
300	4.4	2.8	75	72	0341307572
350	4.4	2.8	30	56	0341353056
350	4.4	2.8	35	56	0341353556
350	4.4	2.8	75	56	0341357556
350	4.4	2.8	80	56	0341358056
350	4.4	2.8	30	72	0341353072
350	4.4	2.8	35	72	0341353572
350	4.4	2.8	75	72	0341357572
350	4.4	2.8	80	72	0341358072
400	4.4	3	30	64	0341403064
400	4.4	3	35	64	0341403564
400	4.4	3	75	64	0341407564
400	4.4	3	80	64	0341408064
450	4.4	3.2	30	60	0341453060
450	4.4	3.2	35	60	0341453560
450	4.4	3.2	75	60	0341457560
450	4.4	3.2	80	60	0341458060
450	4.4	3.2	30	72	0341453072
450	4.4	3.2	35	72	0341453572
450	4.4	3.2	75	72	0341457572
450	4.4	3.2	80	72	0341458072



Noise reduction panel sizing saw blade.  
T.C.T. flat + triple-chip tooth.  
Tool body with microleaves.



Disco de sierra silenciado para seccionadoras.  
Diente recto + trapecial de metal duro.  
Cuerpo con microfisuras.



Lame circulaire pour scie à panneaux à bruit réduit.  
Denture plate + trapézoïdale en carbure.  
Corps avec fentes micrométriques.



Geräuscharm Kreissägeblatt für Plattenaufteil maschinen.  
Hartmetallbestückt Trapez - und Flachzahn.  
Körper mit Mikroschlitzten.

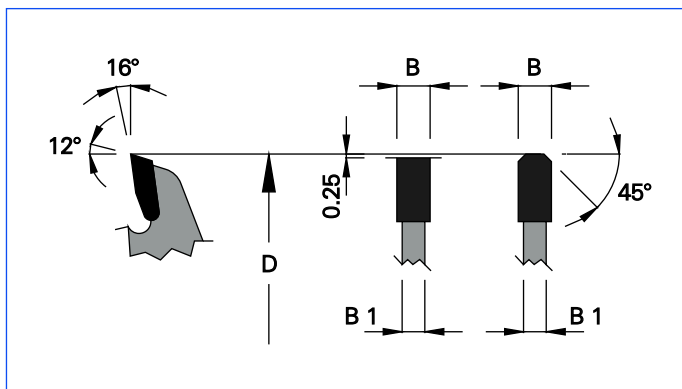
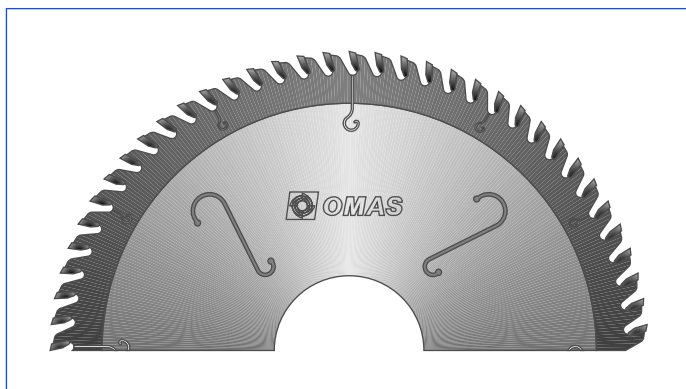

HW

– dente piano + trapezoidale



D	B	B1	d	Z	COD.
300	4.4	2.8	30	60	0340303060
300	4.4	2.8	30	72	0340303072
300	4.4	2.8	35	72	0340303572
300	4.4	2.8	75	72	0340307572
350	4.4	2.8	30	56	0340353056
350	4.4	2.8	35	56	0340353556
350	4.4	2.8	75	56	0340357556
350	4.4	2.8	80	56	0340358056
350	4.4	2.8	30	72	0340353072
350	4.4	2.8	35	72	0340353572
350	4.4	2.8	75	72	0340357572
350	4.4	2.8	80	72	0340358072
400	4.4	3	30	64	0340403064
400	4.4	3	35	64	0340403564
400	4.4	3	75	64	0340407564
400	4.4	3	80	64	0340408064
450	4.4	3.2	30	60	0340453060
450	4.4	3.2	35	60	0340453560
450	4.4	3.2	75	60	0340457560
450	4.4	3.2	80	60	0340458060
450	4.4	3.2	30	72	0340453072
450	4.4	3.2	35	72	0340453572
450	4.4	3.2	75	72	0340457572
450	4.4	3.2	80	72	0340458072



Panel sizing saw blade.  
T.C.T. flat + triple-chip tooth.



Disco de sierra para seccionadoras.  
Diente recto + trapezoidal de metal duro.



Lame circulaire pour scie à panneaux.  
Denture plate + trapézoïdale en carbure.



Kreissägeblatt für Plattenaufteilmaschinen.  
Hartmetallbestückt, Trapez- und Flachzahn.



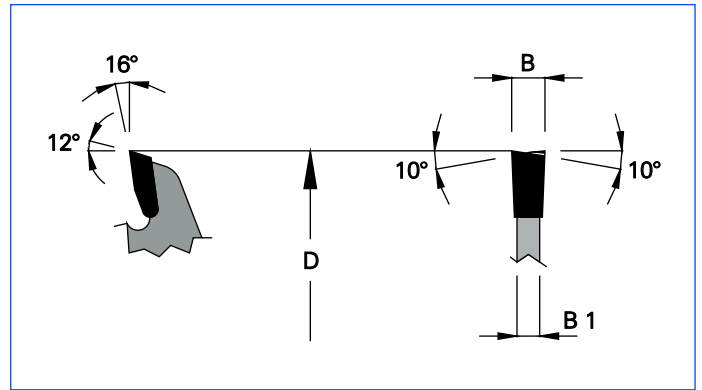
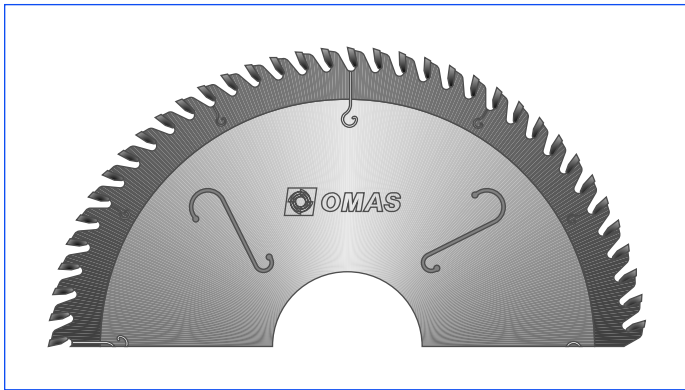

HW

- dente alternato



D	B	B 1	d	Z	COD.
300	4.4	2.8	30	60	0344303060
300	4.4	2.8	30	72	0344303072
300	4.4	2.8	35	72	0344303572
300	4.4	2.8	75	72	0344307572
350	4.4	2.8	30	56	0344353056
350	4.4	2.8	35	56	0344353556
350	4.4	2.8	75	56	0344357556
350	4.4	2.8	80	56	0344358056
350	4.4	2.8	30	72	0344353072
350	4.4	2.8	35	72	0344353572
350	4.4	2.8	75	72	0344357572
350	4.4	2.8	80	72	0344358072
400	4.4	3	30	64	0344403064
400	4.4	3	35	64	0344403564
400	4.4	3	75	64	0344407564
400	4.4	3	80	64	0344408064
450	4.4	3.2	30	60	0344453060
450	4.4	3.2	35	60	0344453560
450	4.4	3.2	75	60	0344457560
450	4.4	3.2	80	60	0344458060
450	4.4	3.2	30	72	0344453072
450	4.4	3.2	35	72	0344453572
450	4.4	3.2	75	72	0344457572
450	4.4	3.2	80	72	0344458072



Panel sizing saw blade.  
T.C.T. alternate bevel tooth.



Disco de sierra para seccionadoras.  
Diente alterno de metal duro.



Lame circulaire pour scie à panneaux.  
Denture alternée en carbure.



Kreissägeblatt für Plattenaufteilmaschinen.  
Hartmetallbestückt Wechselzahn.

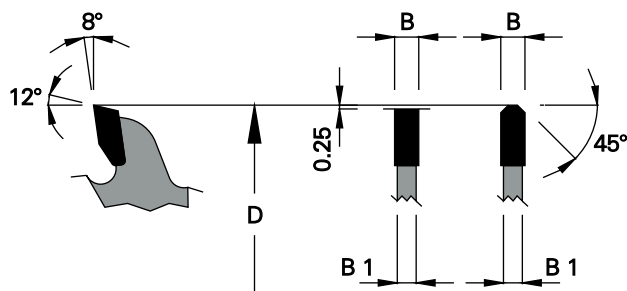

HW

– dente piano + trapezoidale



D	B	B1	d	Z	COD.
250	3.2	2.5	30	60	0346253060
250	3.2	2.5	32	60	0346253260
250	3.2	2.5	30	80	0346253080
250	3.2	2.5	32	80	0346253280
250	3.2	2.5	35	80	0346253580
300	3.4	2.6	30	72	0346303072
300	3.4	2.6	32	72	0346303272
300	3.4	2.6	30	84	0346303084
300	3.4	2.6	32	84	0346303284
300	3.4	2.6	30	96	0346303096
300	3.4	2.6	32	96	0346303296
350	3.6	2.8	30	84	0346353084
350	3.6	2.8	32	84	0346353284
350	3.6	2.8	35	84	0346353584
350	3.6	2.8	30	108	0346353010
350	3.6	2.8	32	108	0346353210
400	3.8	3	32	96	0346403296
420	3.8	3	32	96	0346423296
450	4	3	32	108	0346453210
500	4	3.2	32	120	0346503212



Non-ferrous metal saw blade.  
T.C.T. flat + triple-chip tooth.



Disco de sierra para metales no férricos.  
Diente recto + trapecial de metal duro.



Lame circulaire pour métaux non ferreux.  
Denture plate + trapézoïdale en carbure.



Kreissägeblatt für NE - Metalle.  
Hartmetallbestückt, Trapez- und Flachzahn.

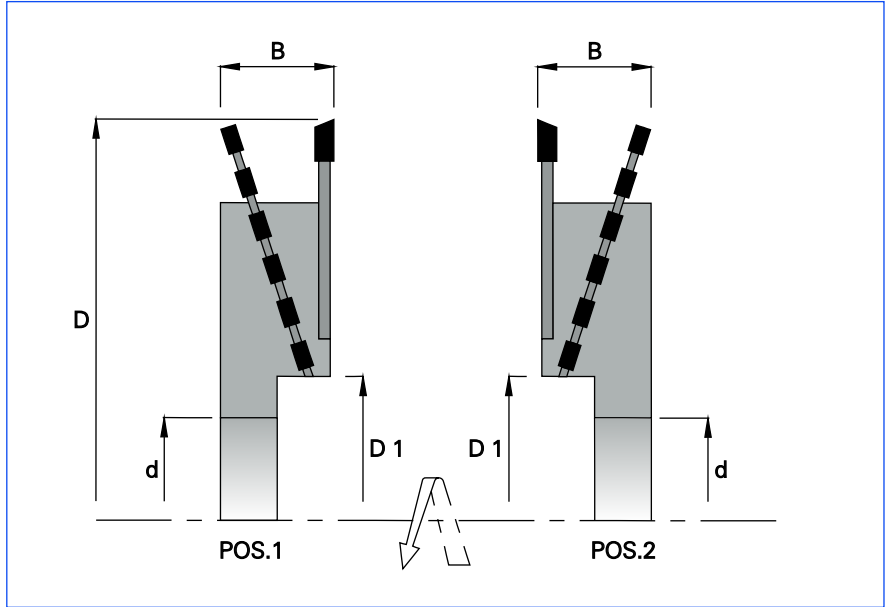

**HW**

**MEC**

– corpo in lega leggera

D	B	d	D1	Z		COD. POS.1	COD. POS.2
255	35	60	118	57	3	0350605701	0350605702
255	35	80	118	57	3	0350805701	0350805702
255	35	60	118	77	3	0350607701	0350607702
255	35	80	118	77	3	0350807701	0350807702



**Ricambi / Spare parts / Rechanges / Repuestos / Ersatzteile**



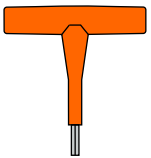

COD.  
0480720610



COD.  
0480784000

 Trimming hogger.  
Light alloy tool body.

 Déchiqueteur.  
Corps de alliage léger.

 Desmenizador.  
Cuerpo de aleacion leggera.

 Zerspaner.  
Körper aus Leichtmetall.

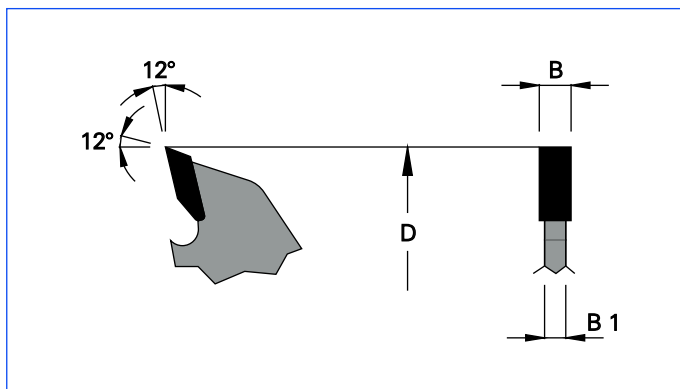
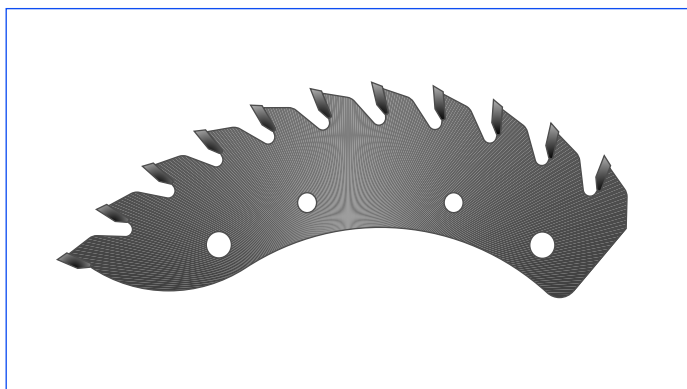



**HW**

— dente piano

D	B	B1	Z	COD. POS.1	COD. POS.2
250	4.3	2.6	11	0351250001	0351250002

 Hogger segments.  
T.C.T. flat tooth.

 Segmentos para desmenuzador.  
Diente recto de metal duro.

 Segments pour déchiqueteur.  
Denture plate en carbure.

 Segmente für Zerspaner.  
Hartmetallbestückt Flachzahn.

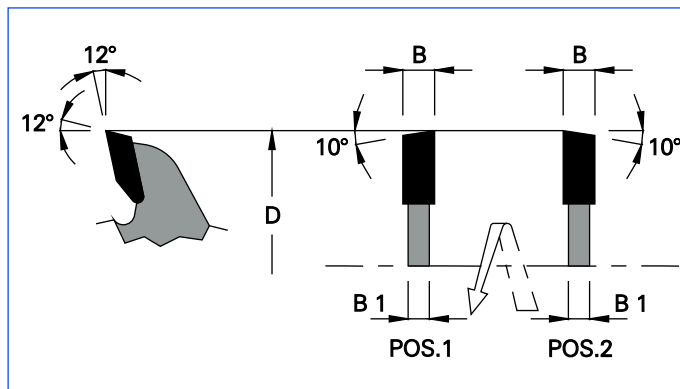
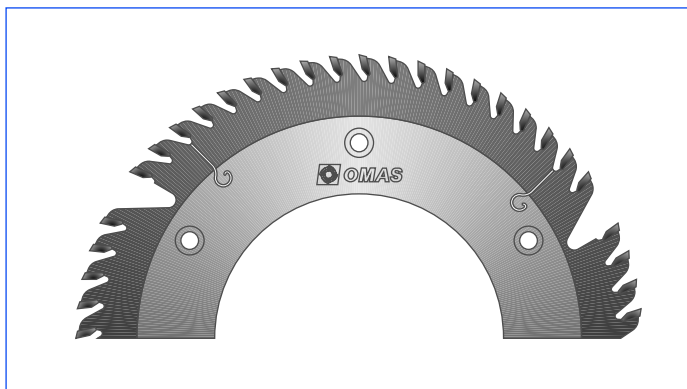



**HW**

— denti inclinati da una sola parte.

D	B	B1	d	Z	COD. POS.1	COD. POS.2
255	4	2.8	130	57	0352255701	0352255702
255	4	2.8	130	77	0352257701	0352257702

 Saw blade for trimming hogger.  
T.C.T. one side bevel tooth.

 Disco de sierra para desmenuzador.  
Diente unilateral de metal duro.

 Lama circulaire pour déchiqueteur.  
Denture en carbure biaisée unilatérale.

 Kreissägeblatt für Zerspaner.  
Hartmetallbestückt, einseitig Spitz.

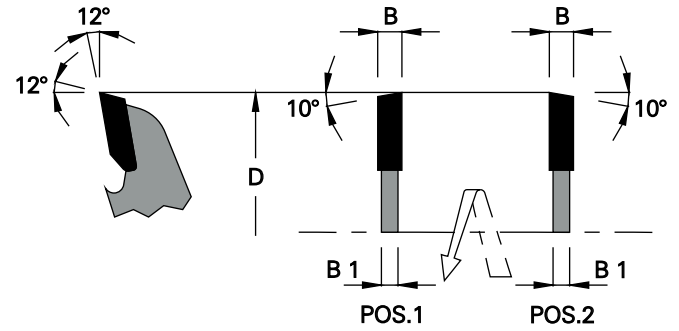

HW

– denti inclinati da una sola parte.

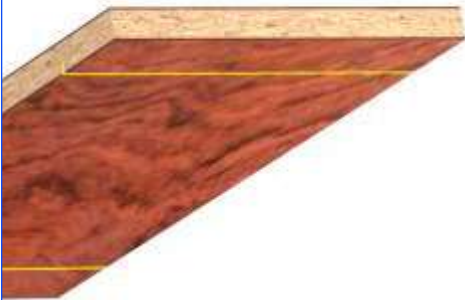

D	B	B1	d	Z	COD. POS.1	COD. POS.2
150	3.2	2.2	55	36	0353155531	0353155532
150	3.2	2.2	60	36	0353156031	0353156032
150	3.2	2.2	55	48	0353155541	0353155542
150	3.2	2.2	60	48	0353156041	0353156042
180	3.2	2.2	55	44	0353185541	0353185542
180	3.2	2.2	60	44	0353186041	0353186042
180	3.2	2.2	70	44	0353187041	0353187042
180	3.2	2.2	55	56	0353185551	0353185552
180	3.2	2.2	60	56	0353186051	0353186052
180	3.2	2.2	70	56	0353187051	0353187052



Scoring saw blade for double sizing machines.  
T.C.T. one side bevel tooth.



Sierra incisora para esquadadoras dobles.  
Diente unilateral de metal duro.



Lame inciseuse pour scies circulaires doubles.  
Denture en carbure biaisée unilatérale.



Ritz - Kreissägeblatt für Doppelendprofiler.  
Hartmetallbestück, einseitig Spitz.

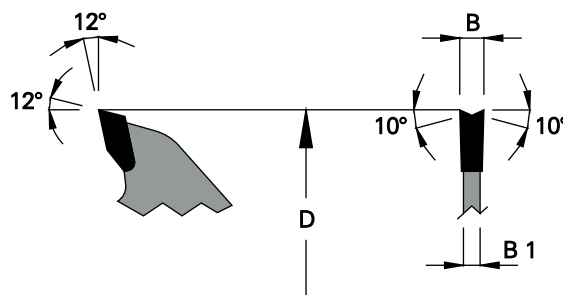

HW

– dente alternato

D	B	B 1	d	Z	COD.
140	2.6	1.8	20	24	0358142024
150	2.6	1.8	20	24	0358152024
160	2.6	1.8	20	24	0358162024
165	2.6	1.8	20	30	0358162030
170	2.6	1.8	20	30	0358172030
180	2.6	1.8	20	24	0358182024
180	2.6	1.8	30	36	0358183036
190	2.8	1.8	30	30	0358193030
200	2.8	1.8	30	30	0358203030
210	2.8	1.8	30	24	0358213024
220	3	1.8	30	36	0358223036
235	3	1.8	30	36	0358233036
250	2.8	1.8	30	60	0358253060
300	2.8	1.8	30	72	0358303072

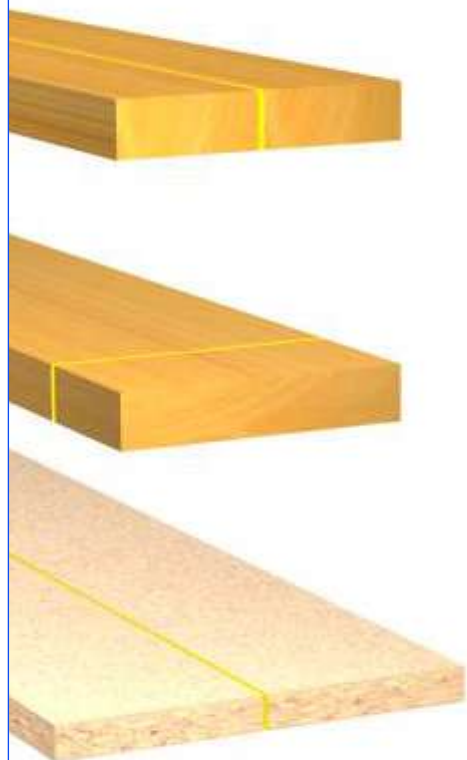

Saw blade for portable saw machines.  
T.C.T. alternate bevel tooth.



Disco de sierra para máquinas portátiles.  
Diente alternativo de metal duro.



Lame circulaire pour machines portatives.  
Denture alternée en carbure.



Kreissägeblatt für Handmaschinen.  
Hartmetallbestück Wechselzahn.

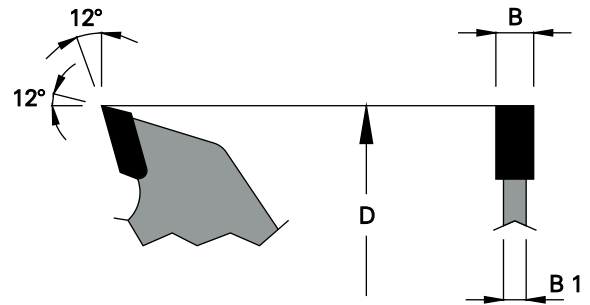

HW

MEC

- dente piano



D	B	B 1	d	Z	COD.
140	4	2.8	30	12	0357140430
140	4	2.8	35	12	0357140435
140	5	3	30	12	0357140530
140	5	3	35	12	0357140535
140	6	3.5	30	12	0357140630
140	6	3.5	35	12	0357140635
150	4	2.8	30	12	0357150430
150	4	2.8	35	12	0357150435
150	5	3	30	12	0357150530
150	5	3	35	12	0357150535
150	6	3.5	30	12	0357150630
150	6	3.5	35	12	0357150635
180	4	2.8	30	18	0357180430
180	4	2.8	35	18	0357180435
180	5	3	30	18	0357180530
180	5	3	35	18	0357180535
180	6	3.5	30	18	0357180630
180	6	3.5	35	18	0357180635



Grooving saw blade.  
T.C.T. flat tooth.



Disco de sierra para ranuras.  
Diente recto de metal duro.



Lame circulaire à rainier.  
Denture plate en carbure.



Nut - Kreissägeblatt.  
Hartmetallbestückt Flachzahn.

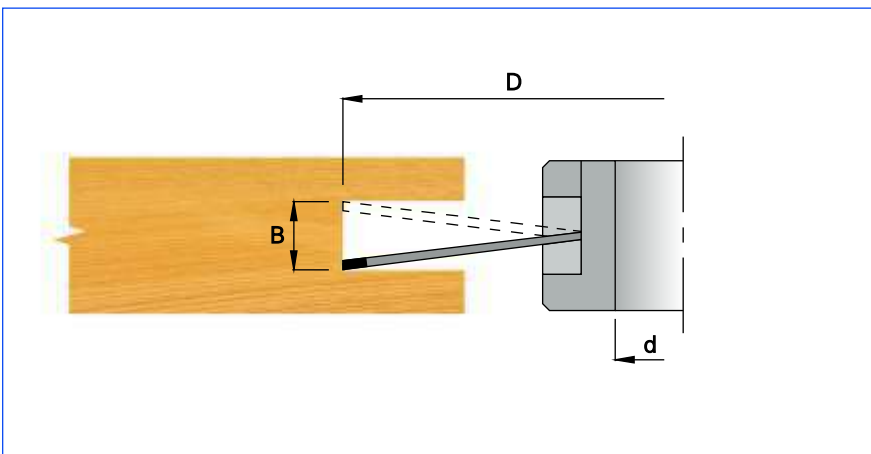

HW

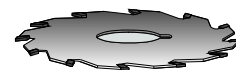

D	B	d	Z	COD.	COD.	COD.
150	3.5-15	30	12	03601530HW	03601530MS	03601545HW
150	3.5-15	31.75	12	03601531HW	03601531MS	03601545HW
200	3.5-18	30	16	03602030HW	03602030MS	03602055HW
200	3.5-18	31.75	16	03602031HW	03602031MS	03602055HW
200	3.5-18	35	16	03602035HW	03602035MS	03602055HW
250	3.5-20	30	20	03602530HW	03602530MS	03602555HW
250	3.5-20	31.75	20	03602531HW	03602531MS	03602555HW
250	3.5-20	35	20	03602535HW	03602535MS	03602555HW
250	3.5-20	40	20	03602540HW	03602540MS	03602570HW
250	3.5-20	50	20	03602550HW	03602550MS	03602570HW

## Ricambi / Spare parts / Rechanges / Repuestos / Ersatzteile

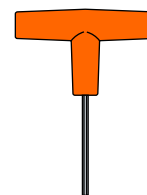

D	d	COD.	COD.
150	30	048072B410	0480783000
150	31.75	048072B310	0480782500
200	30	048072B510	0480784000
200	31.75	048072B510	0480784000
200	35	048072B410	0480783000
250	30	048072B410	0480783000
250	31.75	048072B410	0480783000
250	35	048072B410	0480783000
250	40	048072B410	0480783000
250	50	048072B510	0480784000

Wobble saw.

Dispositivo oscilante.

Appareil oscillant.

Schwinggerät.



# Frese saldobrasate



Cutters with brazed tips



Fraises à mises rapportées



Fresas con dientes soldados



Bestückte Fräser

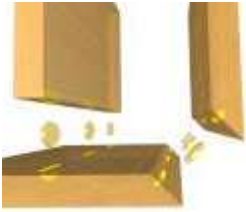

ART. K 195 - MS



3.2

ART. K 195 - P



3.2



ART. K 198



3.3

ART. 200



3.4

ART. 201



3.5



ART. K 202



3.6



ART. K 170



3.8



ART. 385

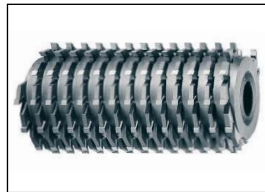

3.7



ART. K 210-B



3.10

ART. K 210-C



3.10



ART. 222-A



3.11

ART. K 223-A



3.11



 Cutters with brazed tips 
  Fraises à mises rapportées 
  Fresas con dientes soldados 
  Bestückte Fräser



# K 195 - MS

## Fresa per minispot

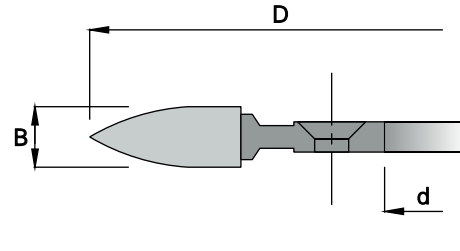

**HW**

**MAN**

n 7700 - 13300



D	B	d	Z	COD.
100	8	22	4	K195MS22HW



Grooving cutter for "minispot".



Fresa para ranuras "minispot".



Fraise à rainner pour "minispot".



Nutfräser für "minispot".

# K 195 - P

## Fresa per incastri sottili

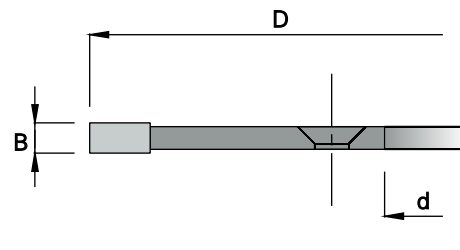

**HW**

**MAN**

n 7700 - 13300

D	B	d	Z	COD.
100	3.96	22	6	K195P022HW

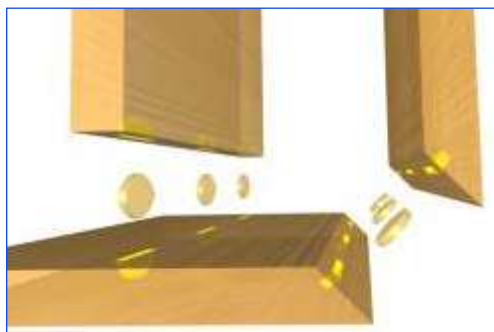

Grooving cutter for thin grooves.



Fresa para ranuras delgadas.



Fraise pour rainures minces.



Nutfräser für dünne Nut.

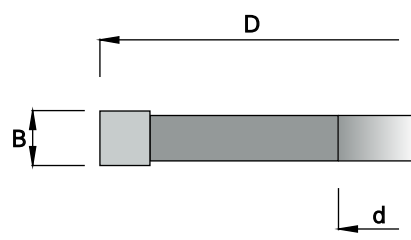

**HW**

**MAN**

n 5500 - 8100



D	B	d	Z	COD.
140	4	30	4	K1980430HW
140	4	35	4	K1980435HW
140	4	40	4	K1980440HW
140	4	50	4	K1980450HW
140	5	30	4	K1980530HW
140	5	35	4	K1980535HW
140	5	40	4	K1980540HW
140	5	50	4	K1980550HW
140	6	30	4	K1980630HW
140	6	35	4	K1980635HW
140	6	40	4	K1980640HW
140	6	50	4	K1980650HW
140	8	30	4	K1980830HW
140	8	35	4	K1980835HW
140	8	40	4	K1980840HW
140	8	50	4	K1980850HW
140	10	30	4	K1981030HW
140	10	35	4	K1981035HW
140	10	40	4	K1981040HW
140	10	50	4	K1981050HW
140	12	30	4	K1981230HW
140	12	35	4	K1981235HW
140	12	40	4	K1981240HW
140	12	50	4	K1981250HW
140	14	30	4	K1981430HW
140	14	35	4	K1981435HW
140	14	40	4	K1981440HW
140	14	50	4	K1981450HW
140	15	30	4	K1981530HW
140	15	35	4	K1981535HW
140	15	40	4	K1981540HW
140	15	50	4	K1981550HW
140	16	30	4	K1981630HW
140	16	35	4	K1981635HW
140	16	40	4	K1981640HW
140	16	50	4	K1981650HW
140	18	30	4	K1981830HW
140	18	35	4	K1981835HW
140	18	40	4	K1981840HW
140	18	50	4	K1981850HW
140	20	30	4	K1982030HW
140	20	35	4	K1982035HW
140	20	40	4	K1982040HW
140	20	50	4	K1982050HW

 Grooving cutter.

 Fraise à rainier.

 Fresa para ranuras.

 Nutfräser.

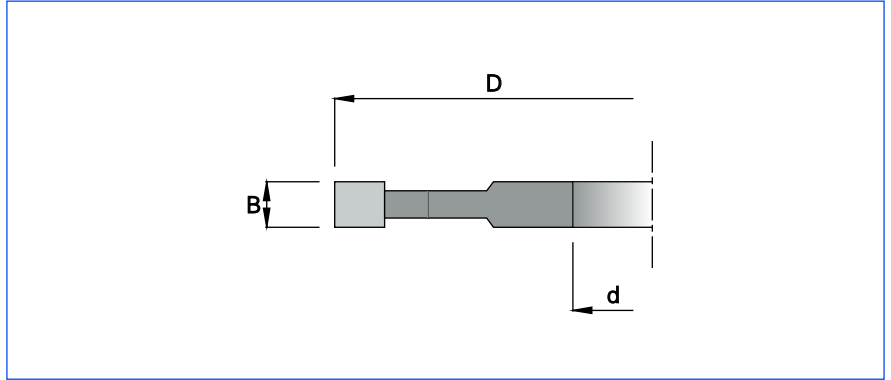

HW

MEC

n max 8100



D	B	d	Z	COD.
140	4	30	6	02000430HW
140	4	35	6	02000435HW
140	4	40	6	02000440HW
140	4	50	6	02000450HW
140	5	30	6	02000530HW
140	5	35	6	02000535HW
140	5	40	6	02000540HW
140	5	50	6	02000550HW
140	6	30	6	02000630HW
140	6	35	6	02000635HW
140	6	40	6	02000640HW
140	6	50	6	02000650HW
140	8	30	6	02000830HW
140	8	35	6	02000835HW
140	8	40	6	02000840HW
140	8	50	6	02000850HW
140	10	30	6	02001030HW
140	10	35	6	02001035HW
140	10	40	6	02001040HW
140	10	50	6	02001050HW
140	12	30	6	02001230HW
140	12	35	6	02001235HW
140	12	40	6	02001240HW
140	12	50	6	02001250HW
140	14	30	6	02001430HW
140	14	35	6	02001435HW
140	14	40	6	02001440HW
140	14	50	6	02001450HW
140	15	30	6	02001530HW
140	15	35	6	02001535HW
140	15	40	6	02001540HW
140	15	50	6	02001550HW
140	16	30	6	02001630HW
140	16	35	6	02001635HW
140	16	40	6	02001640HW
140	16	50	6	02001650HW
140	18	30	6	02001830HW
140	18	35	6	02001835HW
140	18	40	6	02001840HW
140	18	50	6	02001850HW
140	20	30	6	02002030HW
140	20	35	6	02002035HW
140	20	40	6	02002040HW
140	20	50	6	02002050HW



Grooving cutter.



Fresa para ranuras.



Fraise à rainier.



Nutfräser.

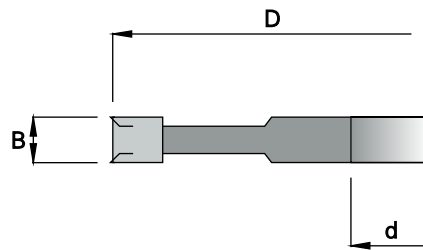

HW

MEC

n max 8100



D	B	d	Z	V	COD.
140	4	30	4	4	02010430HW
140	4	35	4	4	02010435HW
140	4	40	4	4	02010440HW
140	4	50	4	4	02010450HW
140	5	30	4	4	02010530HW
140	5	35	4	4	02010535HW
140	5	40	4	4	02010540HW
140	5	50	4	4	02010550HW
140	6	30	4	4	02010630HW
140	6	35	4	4	02010635HW
140	6	40	4	4	02010640HW
140	6	50	4	4	02010650HW
140	8	30	4	4	02010830HW
140	8	35	4	4	02010835HW
140	8	40	4	4	02010840HW
140	8	50	4	4	02010850HW
140	10	30	4	4	02011030HW
140	10	35	4	4	02011035HW
140	10	40	4	4	02011040HW
140	10	50	4	4	02011050HW
140	12	30	4	4	02011230HW
140	12	35	4	4	02011235HW
140	12	40	4	4	02011240HW
140	12	50	4	4	02011250HW
140	14	30	4	4	02011430HW
140	14	35	4	4	02011435HW
140	14	40	4	4	02011440HW
140	14	50	4	4	02011450HW
140	15	30	4	4	02011530HW
140	15	35	4	4	02011535HW
140	15	40	4	4	02011540HW
140	15	50	4	4	02011550HW
140	16	30	4	4	02011630HW
140	16	35	4	4	02011635HW
140	16	40	4	4	02011640HW
140	16	50	4	4	02011650HW
140	18	30	4	4	02011830HW
140	18	35	4	4	02011835HW
140	18	40	4	4	02011840HW
140	18	50	4	4	02011850HW
140	20	30	4	4	02012030HW
140	20	35	4	4	02012035HW
140	20	40	4	4	02012040HW
140	20	50	4	4	02012050HW

Grooving cutter with spurs.

Fresa para ranuras con precortadores.

Fraise à rainier avec traceurs.

Nutfräser mit Vorschneidern.

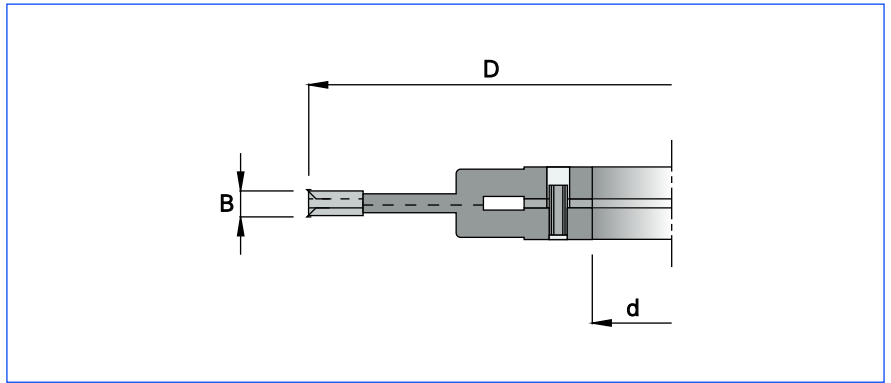

**HW**

**MAN**

D 160 n 4800 - 7100  
D 200 n 3900 - 5700

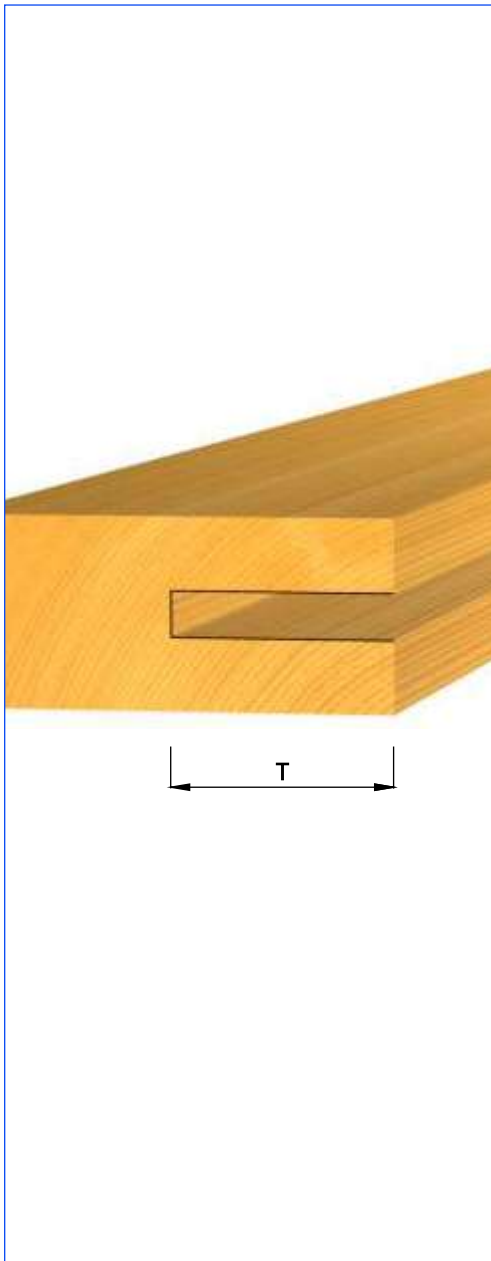

D	B	d	T	Z	V	COD.
160	4:7.8	30	30	4	4	K202160430
160	4:7.8	35	30	4	4	K202160435
160	4:7.8	40	30	4	4	K202160440
160	4:7.8	50	30	4	4	K202160450
160	7.8:15.4	30	30	4	4	K202160730
160	7.8:15.4	35	30	4	4	K202160735
160	7.8:15.4	40	30	4	4	K202160740
160	7.8:15.4	50	30	4	4	K202160750
160	15.4:30.6	30	53	4	4	K202161530
160	15.4:30.6	35	50	4	4	K202161535
160	15.4:30.6	40	48	4	4	K202161540
160	15.4:30.6	50	43	4	4	K202161550
200	4:7.8	30	45	4	4	K202200430
200	4:7.8	35	45	4	4	K202200435
200	4:7.8	40	45	4	4	K202200440
200	4:7.8	50	45	4	4	K202200450
200	7.8:15.4	30	45	4	4	K202200730
200	7.8:15.4	35	45	4	4	K202200735
200	7.8:15.4	40	45	4	4	K202200740
200	7.8:15.4	50	45	4	4	K202200750
200	15.4:30.6	30	73	4	4	K202201530
200	15.4:30.6	35	70	4	4	K202201535
200	15.4:30.6	40	68	4	4	K202201540
200	15.4:30.6	50	63	4	4	K202201550



Grooving cutter adjustable by spacers.



Fresa para ranuras regulable con anillos.



Fraise à rainner extensible.

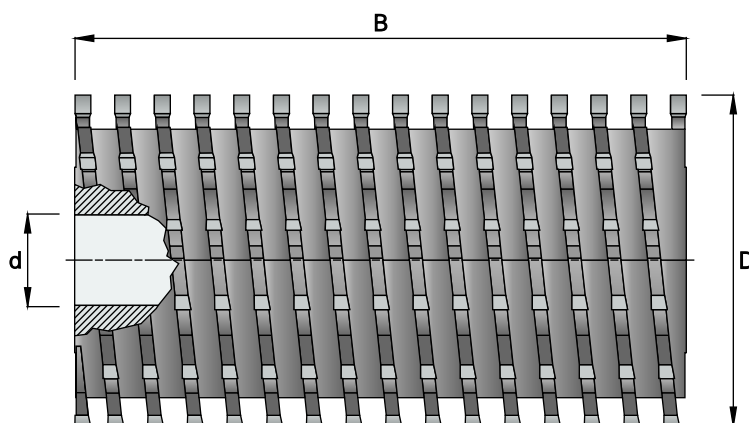

Nutfräser verstellbar durch Zwischenringen.

**HW****MEC**

D 80 n max. 14300  
 D 100 n max. 11400  
 D 125 n max. 9100

D	B	d	Z	COD.
80	80	35	8	0385080835
100	120	35	8	0385101235
100	190	35	8	0385101835
125	80	40	12	0385120840
125	100	40	12	0385121040
125	120	40	12	0385121240
125	130	40	12	0385121340
125	150	40	12	0385121540
125	180	40	12	0385121840
125	190	40	12	0385121940
125	210	40	12	0385122140
125	230	40	12	0385122340
125	245	40	12	0385122440



 Spiral planer cutter.

 Fresa cepilladora helicoidal.

 Fraise à calibrer, coupe helicoidale.

 Spiral - Hobelfräser.





**HW**

**MAN**

D 120 n 6400 - 9500  
D 160 n 4800 - 7100

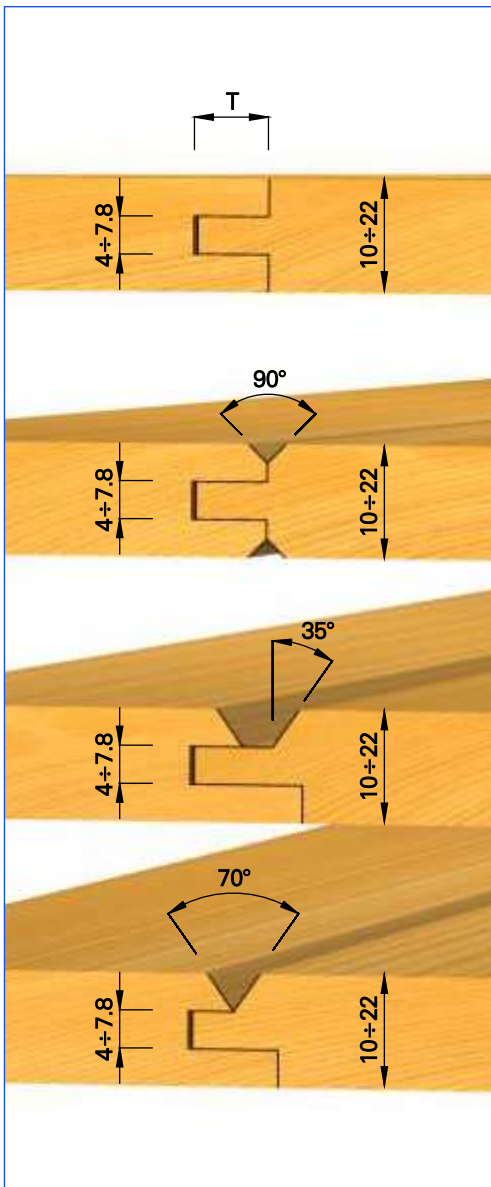
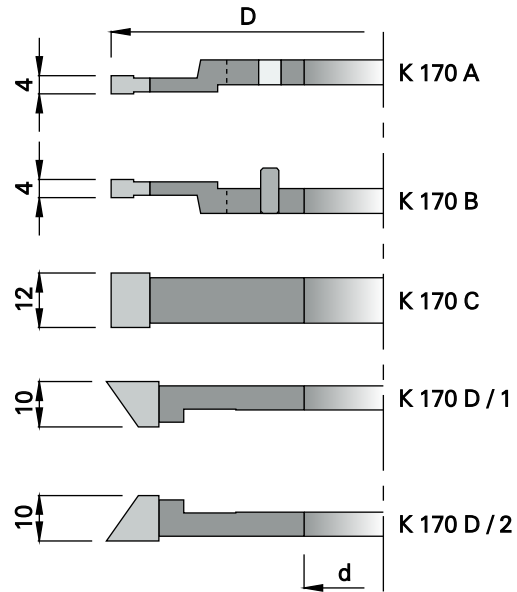

### SET COMPLETO.

D	d	T	Z	COD. SET
120	30	18	2	K1700030HW
120	31.75	18	2	K1700031HW
120	35	18	2	K1700035HW
120	40	18	2	K1700040HW
160	50	25	2	K1700050HW

ART.	D	d 30 COD.	d 31.75 COD.
K170 - A	120	K170A030HW	K170A031HW
K170 - B	120	K170B030HW	K170B031HW
K170 - C	120	K170C030HW	K170C031HW
K170 - D/1	120	K170D130HW	K170D131HW
K170 - D/2	120	K170D230HW	K170D231HW

ART.	D	d 35 COD.	d 40 COD.
K170 - A	120	K170A035HW	K170A040HW
K170 - B	120	K170B035HW	K170B040HW
K170 - C	120	K170C035HW	K170C040HW
K170 - D/1	120	K170D135HW	K170D140HW
K170 - D/2	120	K170D235HW	K170D240HW

ART.	D	d 50 COD.
K170 - A	160	K170A050HW
K170 - B	160	K170B050HW
K170 - C	160	K170C050HW
K170 - D/1	160	K170D150HW
K170 - D/2	160	K170D250HW



Tongue and groove cutter set.



Juego de fresas para machihembrados y juntas.



Jeu de fraises pour rainures et bouvetage.



Fräsersatz für Nut - und Feder.

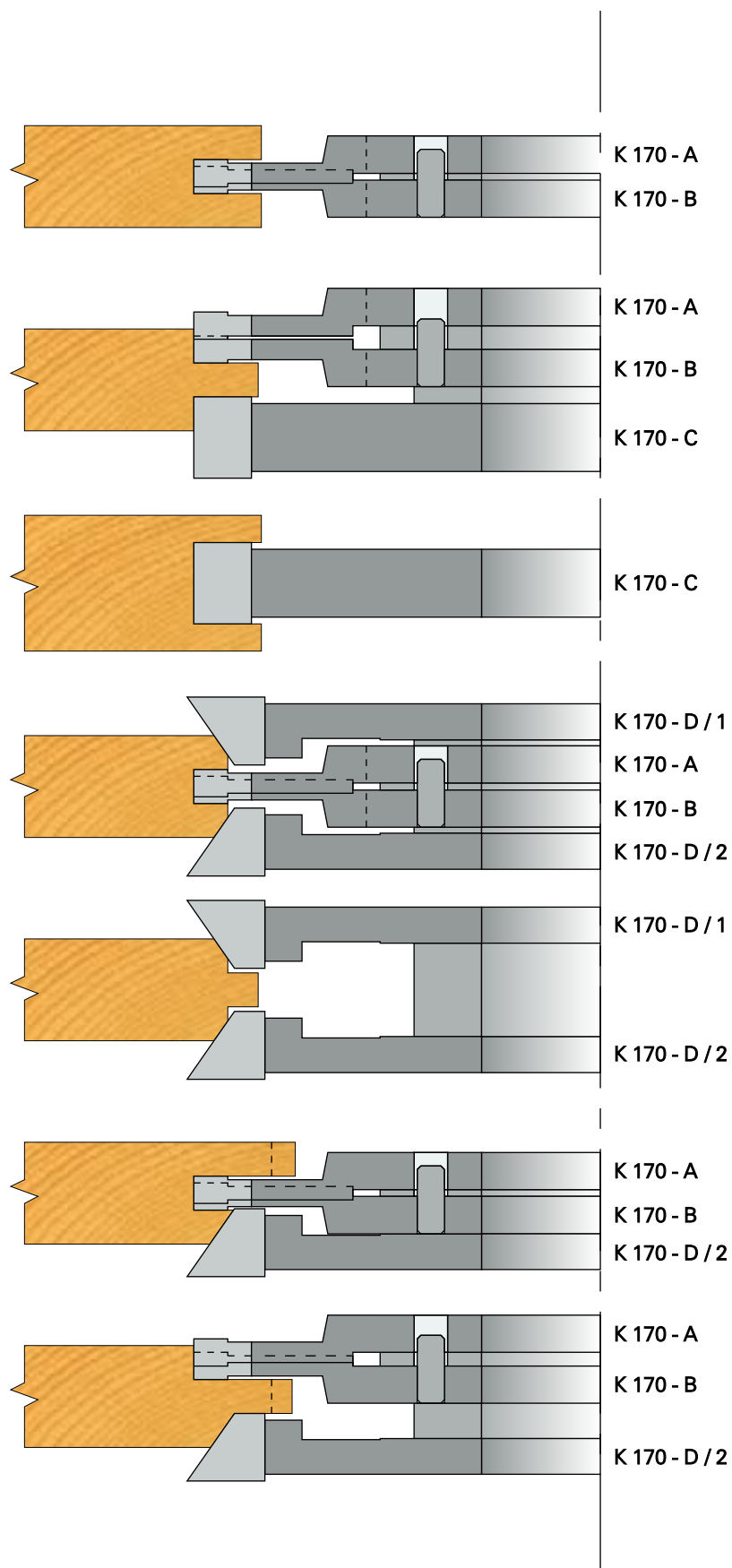

# K 210 - B

## Fresa per smussi

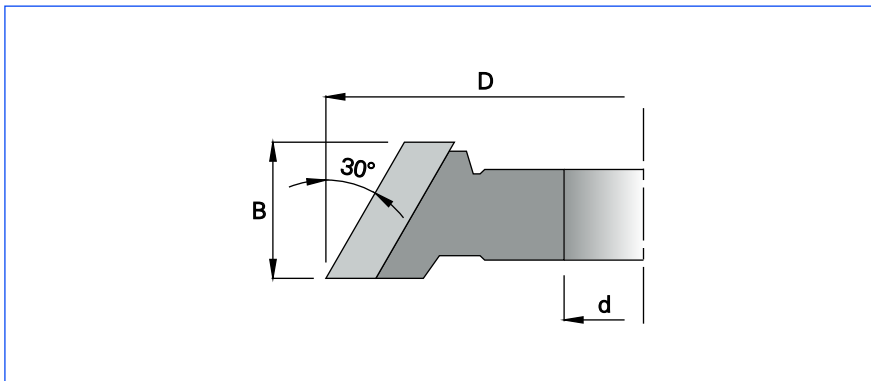

**HW**

**MAN**

n 5500 - 8100



D	B	d	Z	COD.
140	30	30	4	K210B030HW
140	30	35	4	K210B035HW
140	30	40	4	K210B040HW
140	30	50	4	K210B050HW

# K 210 - C

## Fresa per smussi

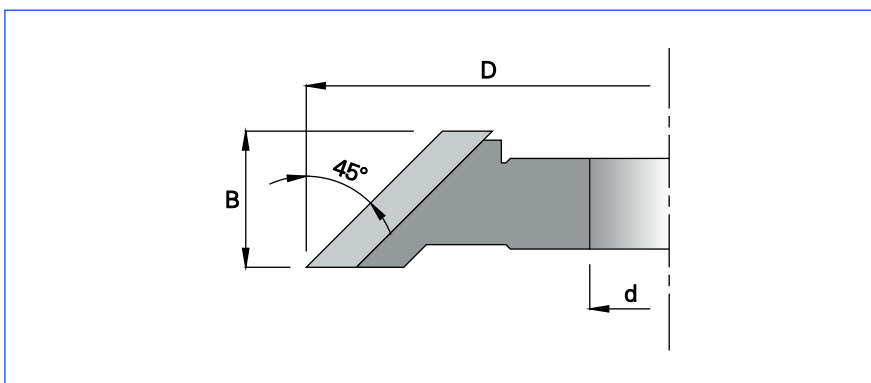

**HW**

**MAN**

n 4800 - 7100



D	B	d	Z	COD.
160	30	30	4	K210C030HW
160	30	35	4	K210C035HW
160	30	40	4	K210C040HW
160	30	50	4	K210C050HW

 Beveling cutter.

 Fresa para biselar.

 Fraise pour chanfrein.

 Fasefräser.

# 222 - A

## Fresa per giunzioni

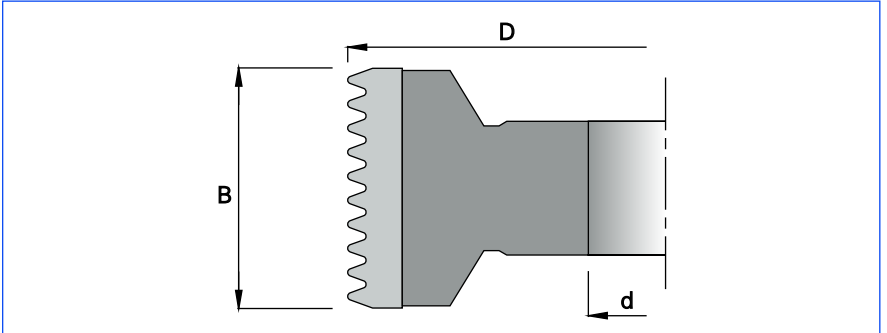

**HW**

**MEC**

HW - n max 8100

D	B	d	Z	COD.
140	53	30	4	0222A030HW
140	53	35	4	0222A035HW
140	53	40	4	0222A040HW
140	53	50	4	0222A050HW

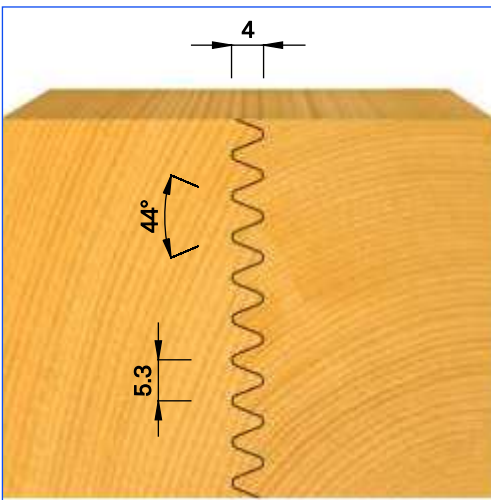

# K 223 - A

## Fresa per giunzioni

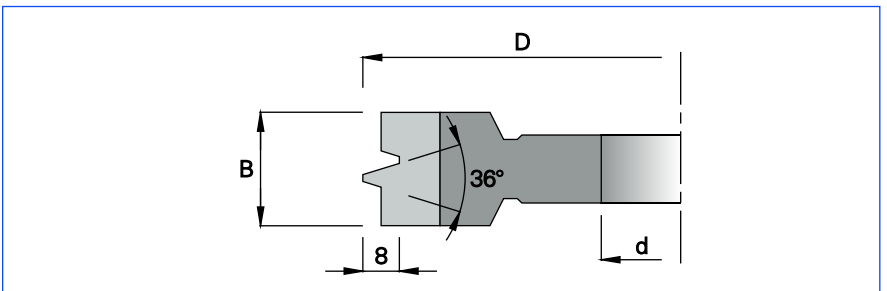

**HW**

**MAN**

n 5500 - 8100

D	B	d	Z	COD.
140	25	30	4	K223A030HW
140	25	35	4	K223A035HW
140	25	40	4	K223A040HW
140	25	50	4	K223A050HW

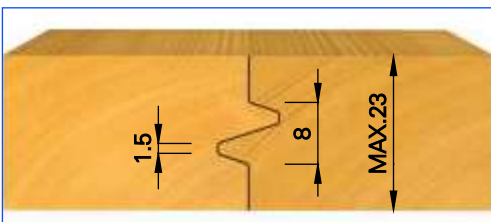

Glue joint cutter.

Fresa para juntas encoladas.

Fraise à bouverter.

Verleimfräser.

# K 223 - B

## Fresa per giunzioni

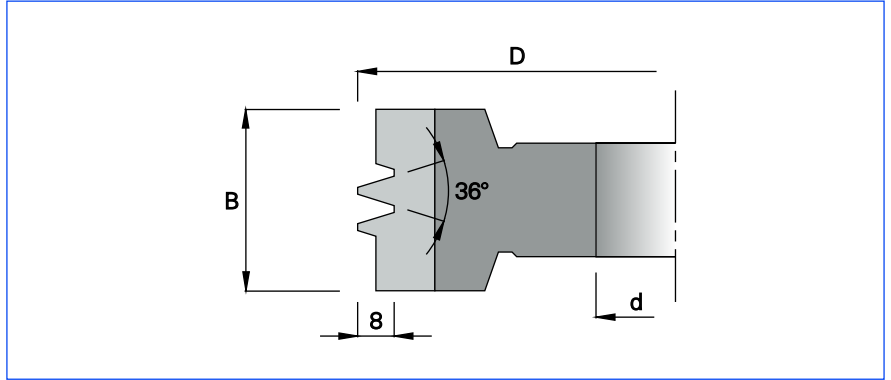

HW

MAN

n 5500 - 8100

D	B	d	Z	COD.
140	40	30	4	K223B030HW
140	40	35	4	K223B035HW
140	40	40	4	K223B040HW
140	40	50	4	K223B050HW

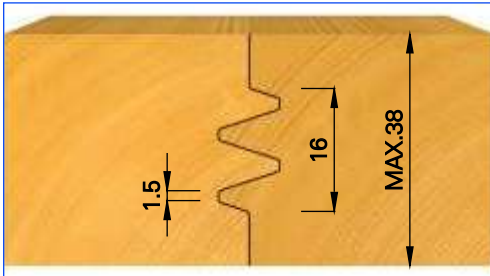

# K 223 - C

## Fresa per giunzioni

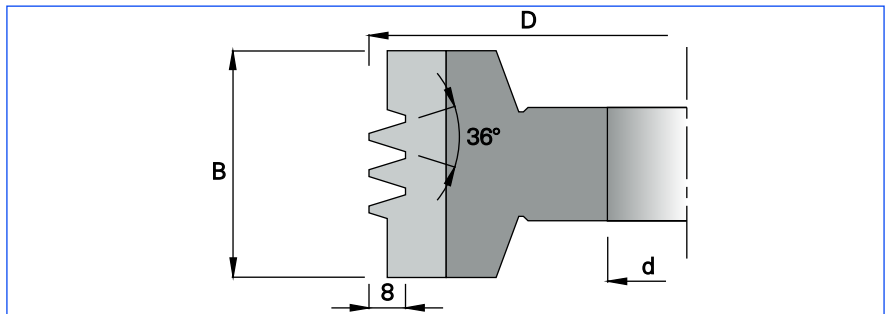



HW

MAN

n 5500 - 8100

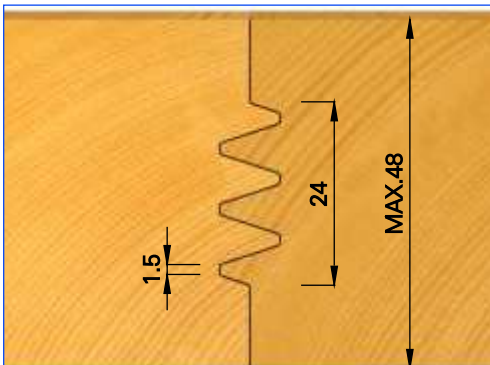
D	B	d	Z	COD.
140	50	30	4	K223C030HW
140	50	35	4	K223C035HW
140	50	40	4	K223C040HW
140	50	50	4	K223C050HW



 Glue joint cutter.

 Fresa para juntas encoladas.

 Fraise à bouveter.

 Verleimfräser.



**HW**

**MEC**

n max 8100

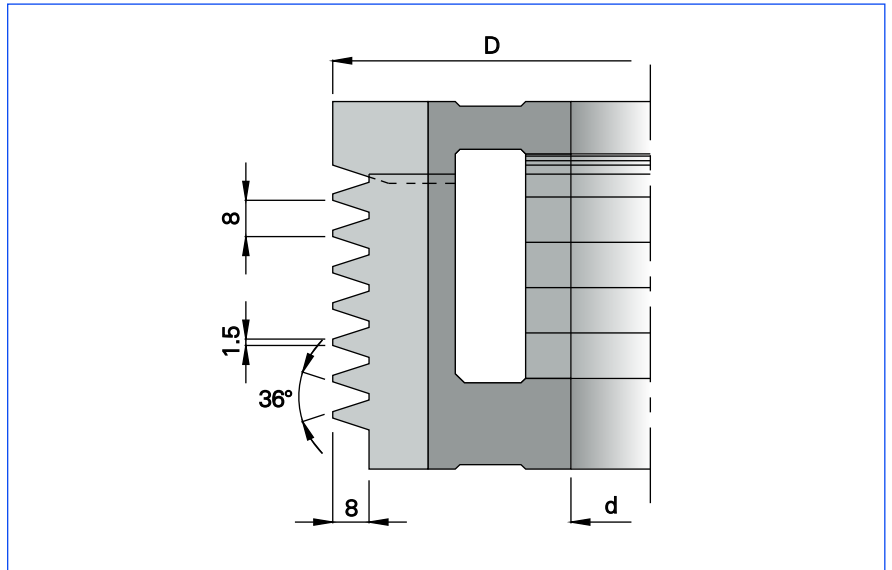

D	d	Z	COD.
140	30	3	0223R030HW
140	35	3	0223R035HW
140	40	3	0223R040HW
140	50	3	0223R050HW

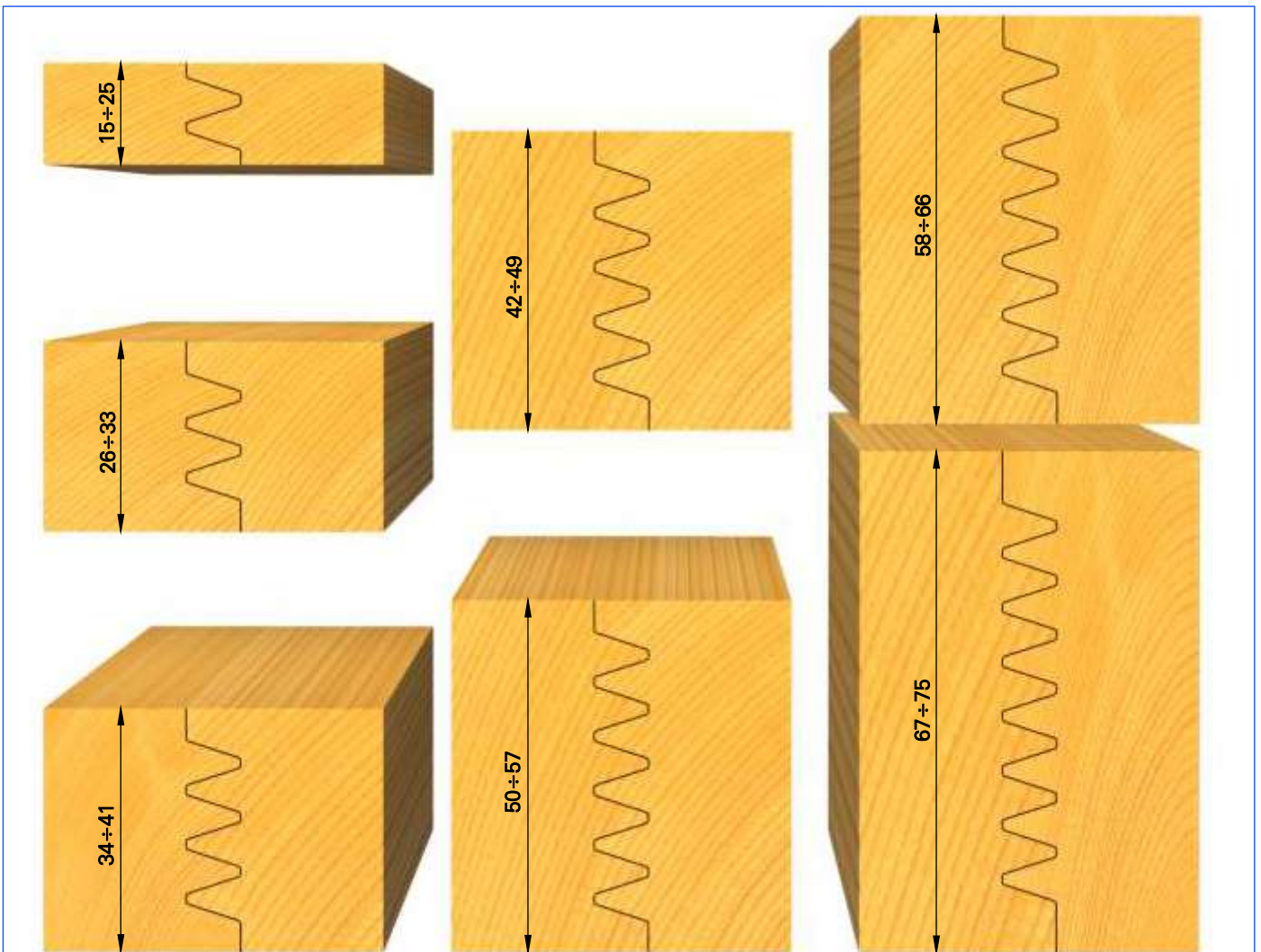

 Adjustable glue joint cutter.

 Fresa extensible para juntas encoladas.

 Fraise à bouveter extensible.

 Verstellbar Verleimfräser.

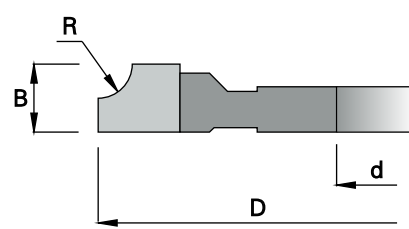

**HW**

**MAN**

D 140 n 5500 - 8100  
 D 150 n 5100 - 7600  
 D 160 n 4800 - 7100  
 D 170 n 4500 - 6700  
 D 180 n 4300 - 6300  
 D 200 n 3900 - 5700

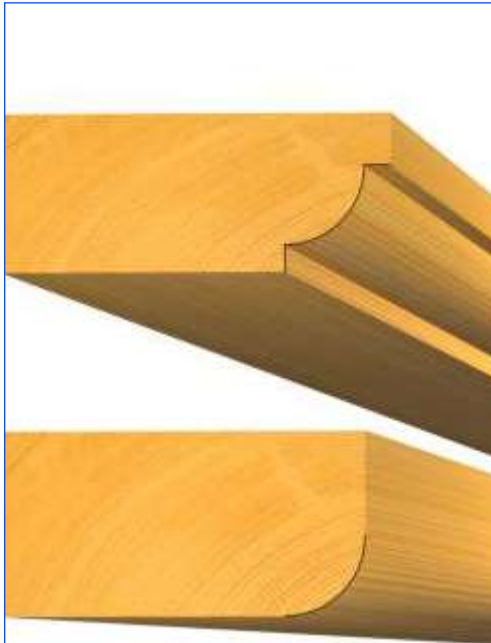



D	R	B	d	Z	COD.
140	5	13	30	4	K2140530HW
140	5	13	35	4	K2140535HW
140	5	13	40	4	K2140540HW
140	5	13	50	4	K2140550HW
140	7.5	15	30	4	K2140730HW
140	7.5	15	35	4	K2140735HW
140	7.5	15	40	4	K2140740HW
140	7.5	15	50	4	K2140750HW
140	10	18	30	4	K2141030HW
140	10	18	35	4	K2141035HW
140	10	18	40	4	K2141040HW
140	10	18	50	4	K2141050HW
140	12.5	20	30	4	K2141230HW
140	12.5	20	35	4	K2141235HW
140	12.5	20	40	4	K2141240HW
140	12.5	20	50	4	K2141250HW
140	15	23	30	4	K2141530HW
140	15	23	35	4	K2141535HW
140	15	23	40	4	K2141540HW
140	15	23	50	4	K2141550HW
140	20	28	30	4	K2142030HW
140	20	28	35	4	K2142035HW
140	20	28	40	4	K2142040HW
140	20	28	50	4	K2142050HW
140	25	33	30	4	K2142530HW
140	25	33	35	4	K2142535HW
140	25	33	40	4	K2142540HW
150	25	33	50	4	K2142550HW
160	30	38	30	4	K2143030HW
160	30	38	35	4	K2143035HW
160	30	38	40	4	K2143040HW
160	30	38	50	4	K2143050HW
160	35	43	30	4	K2143530HW
160	35	43	35	4	K2143535HW
160	35	43	40	4	K2143540HW
170	35	43	50	4	K2143550HW
180	40	48	30	4	K2144030HW
180	40	48	35	4	K2144035HW
180	40	48	40	4	K2144040HW
180	40	48	50	4	K2144050HW
200	45	53	30	4	K2144530HW
200	45	53	35	4	K2144535HW
200	45	53	40	4	K2144540HW
200	45	53	50	4	K2144550HW



D	R	B	d	Z	COD.
200	50	58	30	4	K2145030HW
200	50	58	35	4	K2145035HW
200	50	58	40	4	K2145040HW
200	50	58	50	4	K2145050HW

 Cutter for quarter round.

 Fresa para cuartos de redondo.

 Fraise pour quart de rond.

 Viertelstabfräser.



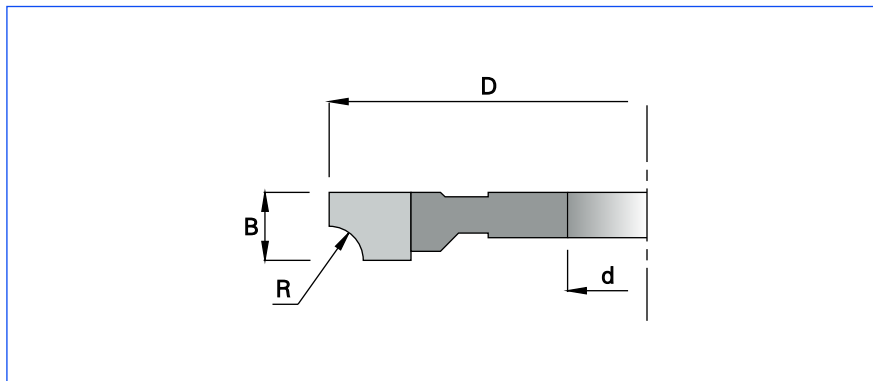

**HW**

**MAN**

D 140 n 5500 - 8100  
 D 150 n 5100 - 7600  
 D 160 n 4800 - 7100  
 D 170 n 4500 - 6700  
 D 180 n 4300 - 6300  
 D 200 n 3900 - 5700

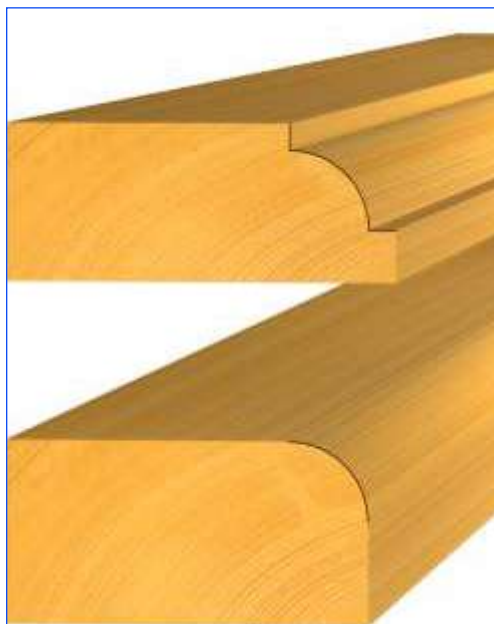



D	R	B	d	Z	COD.
140	5	13	30	4	K2140530BW
140	5	13	35	4	K2140535BW
140	5	13	40	4	K2140540BW
140	5	13	50	4	K2140550BW
140	7.5	15	30	4	K2140730BW
140	7.5	15	35	4	K2140735BW
140	7.5	15	40	4	K2140740BW
140	7.5	15	50	4	K2140750BW
140	10	18	30	4	K2141030BW
140	10	18	35	4	K2141035BW
140	10	18	40	4	K2141040BW
140	10	18	50	4	K2141050BW
140	12.5	20	30	4	K2141230BW
140	12.5	20	35	4	K2141235BW
140	12.5	20	40	4	K2141240BW
140	12.5	20	50	4	K2141250BW
140	15	23	30	4	K2141530BW
140	15	23	35	4	K2141535BW
140	15	23	40	4	K2141540BW
140	15	23	50	4	K2141550BW
140	20	28	30	4	K2142030BW
140	20	28	35	4	K2142035BW
140	20	28	40	4	K2142040BW
140	20	28	50	4	K2142050BW
140	25	33	30	4	K2142530BW
140	25	33	35	4	K2142535BW
140	25	33	40	4	K2142540BW
150	25	33	50	4	K2142550BW
160	30	38	30	4	K2143030BW
160	30	38	35	4	K2143035BW
160	30	38	40	4	K2143040BW
160	30	38	50	4	K2143050BW
160	35	43	30	4	K2143530BW
160	35	43	35	4	K2143535BW
160	35	43	40	4	K2143540BW
170	35	43	50	4	K2143550BW
180	40	48	30	4	K2144030BW
180	40	48	35	4	K2144035BW
180	40	48	40	4	K2144040BW
180	40	48	50	4	K2144050BW
200	45	53	30	4	K2144530BW
200	45	53	35	4	K2144535BW
200	45	53	40	4	K2144540BW
200	45	53	50	4	K2144550BW



D	R	B	d	Z	COD.
200	50	58	30	4	K2145030BW
200	50	58	35	4	K2145035BW
200	50	58	40	4	K2145040BW
200	50	58	50	4	K2145050BW

 Cutter for quarter round.

 Fresa para cuartos de redondo.

 Fraise pour quart de rond.

 Viertelstabfräser.

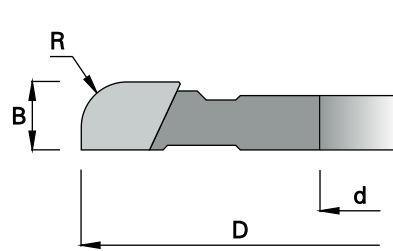

**HW**

**MAN**

n 5500 - 8100



D	R	B	d	Z	COD.
140	10	15	30	4	K2151030HW
140	10	15	35	4	K2151035HW
140	10	15	40	4	K2151040HW
140	10	15	50	4	K2151050HW
140	12.5	17.5	30	4	K2151230HW
140	12.5	17.5	35	4	K2151235HW
140	12.5	17.5	40	4	K2151240HW
140	12.5	17.5	50	4	K2151250HW
140	15	20	30	4	K2151530HW
140	15	20	35	4	K2151535HW
140	15	20	40	4	K2151540HW
140	15	20	50	4	K2151550HW
140	20	25	30	4	K2152030HW
140	20	25	35	4	K2152035HW
140	20	25	40	4	K2152040HW
140	20	25	50	4	K2152050HW



Convex radius cutter.



Fresa con radio convexo.



Fraise pour congés.



Hohlkehlfräser.

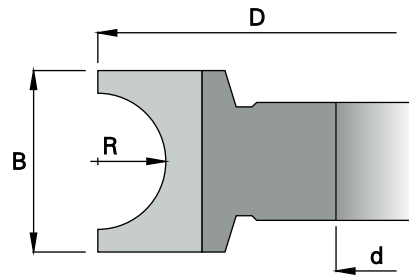

**HW**

**MAN**

n 5500 - 8100



D	R	B	d	Z	COD.
140	5	20	30	4	K2160530HW
140	5	20	35	4	K2160535HW
140	5	20	40	4	K2160540HW
140	5	20	50	4	K2160550HW
140	5.5	20	30	4	K2165530HW
140	5.5	20	35	4	K2165535HW
140	5.5	20	40	4	K2165540HW
140	5.5	20	50	4	K2165550HW
140	6	20	30	4	K2160630HW
140	6	20	35	4	K2160635HW
140	6	20	40	4	K2160640HW
140	6	20	50	4	K2160650HW
140	7.5	25	30	4	K2160730HW
140	7.5	25	35	4	K2160735HW
140	7.5	25	40	4	K2160740HW
140	7.5	25	50	4	K2160750HW
140	10	30	30	4	K2161030HW
140	10	30	35	4	K2161035HW
140	10	30	40	4	K2161040HW
140	10	30	50	4	K2161050HW
140	12.5	35	30	4	K2161230HW
140	12.5	35	35	4	K2161235HW
140	12.5	35	40	4	K2161240HW
140	12.5	35	50	4	K2161250HW
140	15	40	30	4	K2161530HW
140	15	40	35	4	K2161535HW
140	15	40	40	4	K2161540HW
140	15	40	50	4	K2161550HW

 Cutter for half round.

 Fresa para medio redondo.

 Fraise pour demi - rond.

 Halbstabfräser.

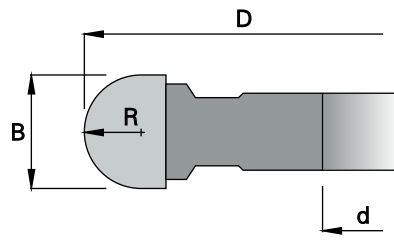

**HW**

**MAN**

n 5500 - 8100

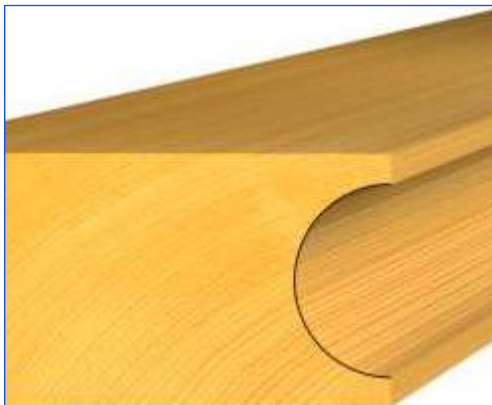

D	R	B	d	Z	COD.
140	4	8	30	4	K2170430HW
140	4	8	35	4	K2170435HW
140	4	8	40	4	K2170440HW
140	4	8	50	4	K2170450HW
140	5	10	30	4	K2170530HW
140	5	10	35	4	K2170535HW
140	5	10	40	4	K2170540HW
140	5	10	50	4	K2170550HW
140	6	12	30	4	K2170630HW
140	6	12	35	4	K2170635HW
140	6	12	40	4	K2170640HW
140	6	12	50	4	K2170650HW
140	7.5	15	30	4	K2170730HW
140	7.5	15	35	4	K2170735HW
140	7.5	15	40	4	K2170740HW
140	7.5	15	50	4	K2170750HW
140	10	20	30	4	K2171030HW
140	10	20	35	4	K2171035HW
140	10	20	40	4	K2171040HW
140	10	20	50	4	K2171050HW
140	12.5	25	30	4	K2171230HW
140	12.5	25	35	4	K2171235HW
140	12.5	25	40	4	K2171240HW
140	12.5	25	50	4	K2171250HW
140	15	30	30	4	K2171530HW
140	15	30	35	4	K2171535HW
140	15	30	40	4	K2171540HW
140	15	30	50	4	K2171550HW



Convex radius cutter.



Fresa con radio convexo.



Fraise pour congés.



Fräser für Kehlungen.

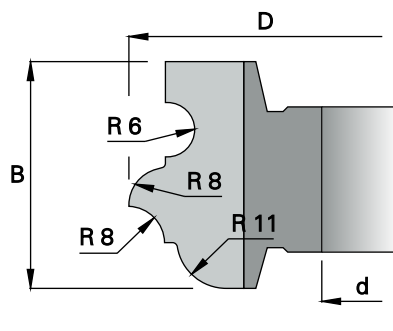

**HW**

**MAN**

D 120 n 6400 - 9500  
D 140 n 5500 - 8100

D	B	d	Z	COD.
120	50	30	2	K1870030HW
120	50	35	2	K1870035HW
140	50	40	2	K1870040HW
140	50	50	2	K1870050HW



 Multi-profile cutter.

 Fresa para perfiles multiples.

 Fraise multi - profil.

 Fräser Multi - Profiler.



**HW**

**MAN**

D 160 n 4800 - 7100  
D 180 n 4300 - 6300

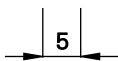
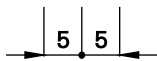
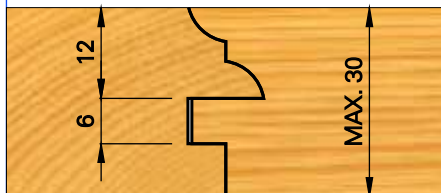
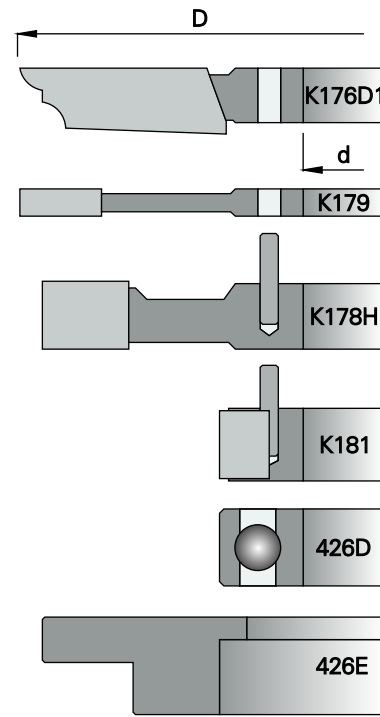

### SET COMPLETO.

D	d	Z	COD. SET
160	30	2	K1760030HW
160	35	2	K1760035HW
180	40	2	K1760040HW
180	50	2	K1760050HW

ART.	D	d 30 COD.	d 35 COD.
K176 - D1	160	K176D130HW	K176D135HW
K179	160	K1790030HW	K1790035HW
K178 - H	150	K178H030HW	K178H035HW
K181	72	K1810030HW	K1810035HW
426 - D	72	0426D00030	0426D00035
426 - E	150	0426E00030	0426E00035

ART.	D	d 40 COD.	d 50 COD.
K176 - D1	180	K176D140HW	K176D150HW
K179	180	K1790040HW	K1790050HW
K178 - H	170	K178H040HW	K178H050HW
K181	90	K1810040HW	K1810050HW
426 - D	90	0426D00040	0426D00050
426 - E	170	0426E00040	0426E00050



Cutter set for furniture doors.



Juego de fresas para puertas de muebles.



Jeu de fraises pour moulure, contre - profil et plate - bande.



Fräsersatz für Abplatte, Profil und Konterprofil.

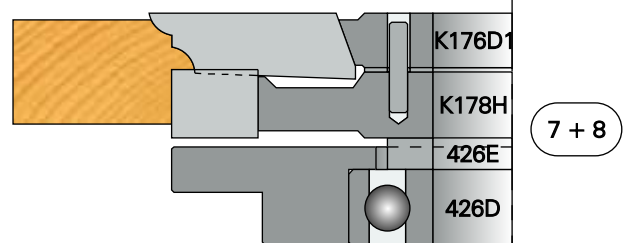
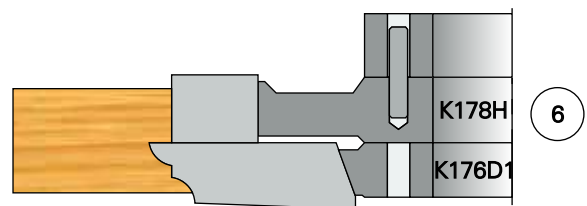
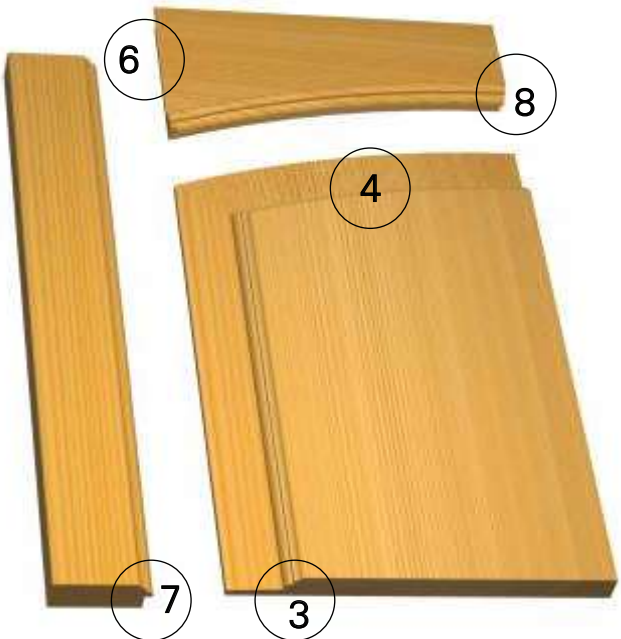
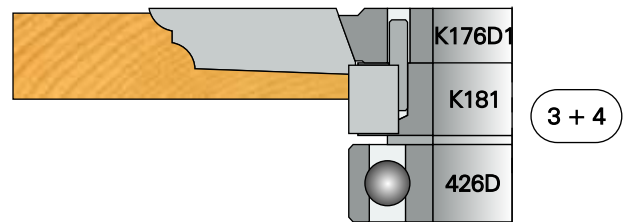
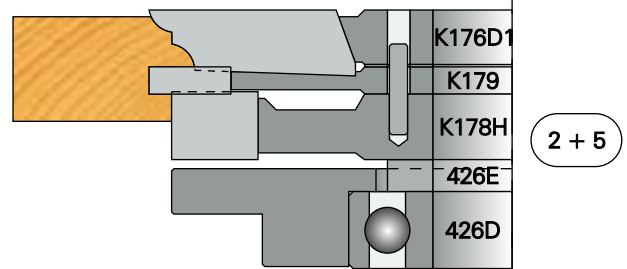
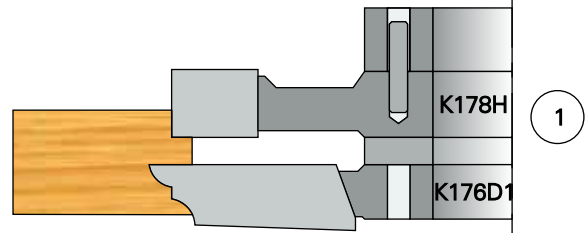
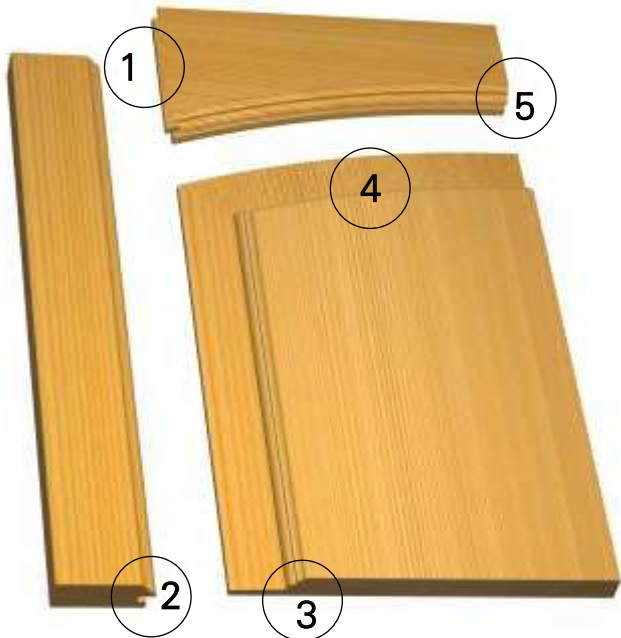





**HS**

**MEC**

D 160 n max 6500  
D 180 n max 5800

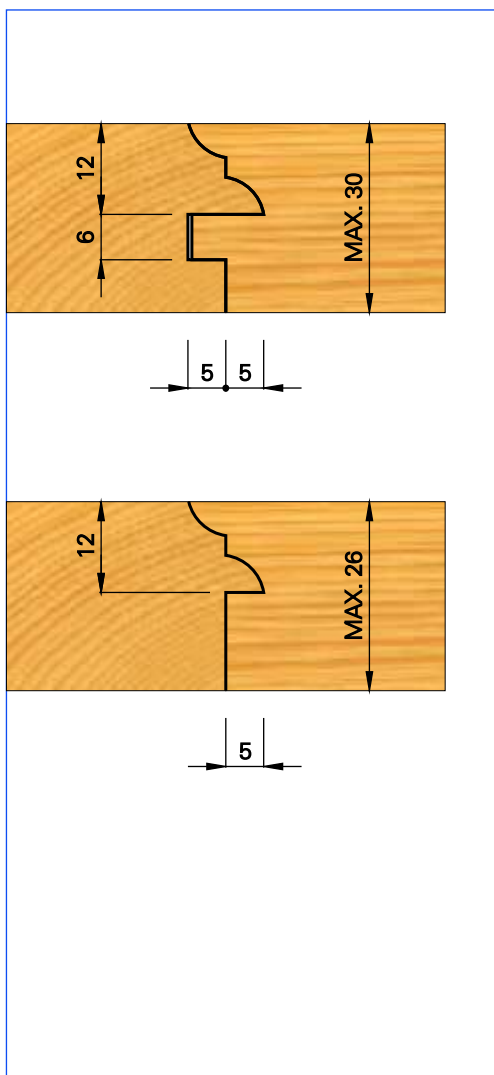
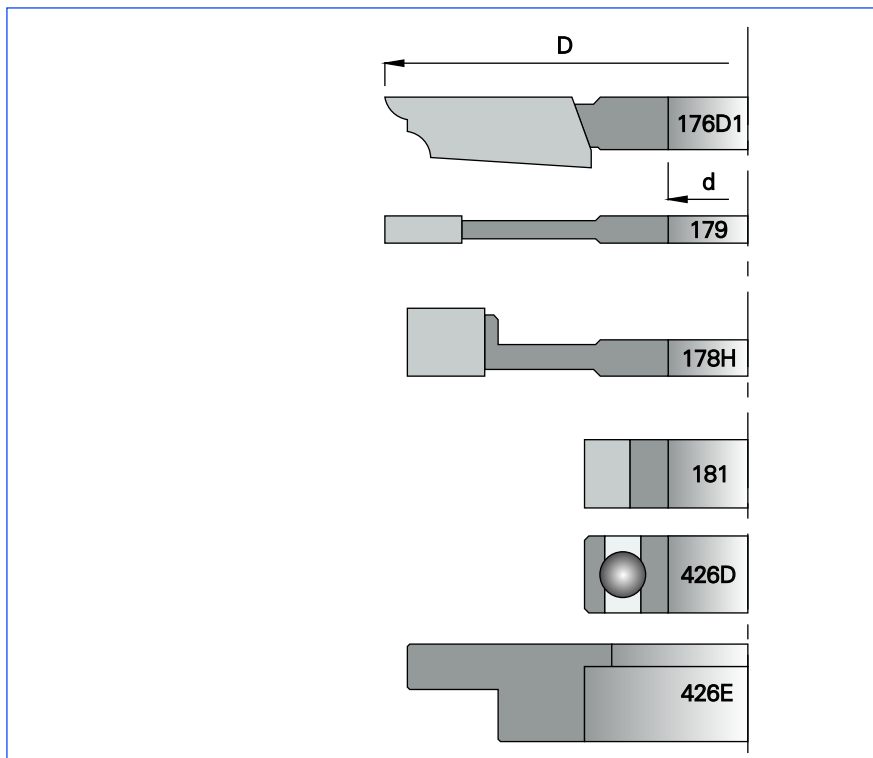

**SET COMPLETO.**

D	d	Z	COD. SET
160	30	2	01760030HS
160	35	2	01760035HS
180	40	2	01760040HS
180	50	2	01760050HS

ART.	D	d 30 COD.	d 35 COD.
176 - D1	160	0176D130HS	0176D135HS
179	160	01790030HS	01790035HS
178 - H	150	0178H030HS	0178H035HS
181	72	01810030HS	01810035HS
426 - D	72	0426D00030	0426D00035
426 - E	150	0426E00030	0426E00035

ART.	D	d 40 COD.	d 50 COD.
176 - D1	180	0176D140HS	0176D150HS
179	180	01790040HS	01790050HS
178 - H	170	0178H040HS	0178H050HS
181	90	01810040HS	01810050HS
426 - D	90	0426D00040	0426D00050
426 - E	170	0426E00040	0426E00050



Cutter set for furniture doors.



Juego de fresas para puertas de muebles.



Jeu de fraises pour moulure, contre - profil et plate - bande.



Fräsersatz für Abplatte, Profil und Konterprofil.

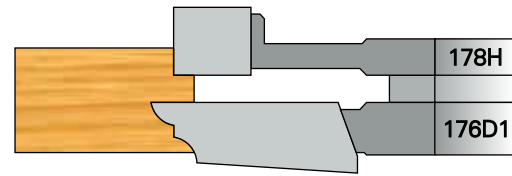
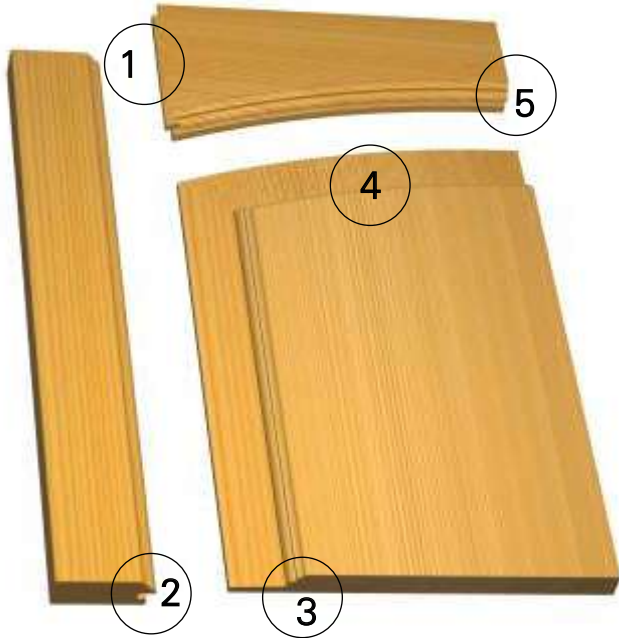

1

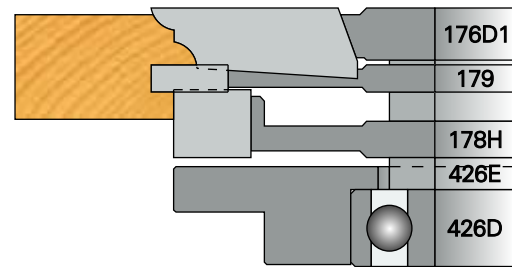

2 + 5

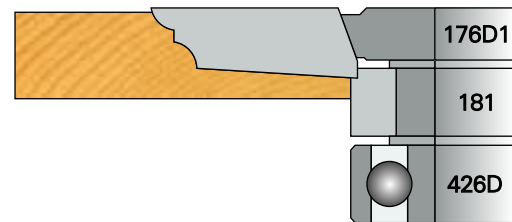

3 + 4

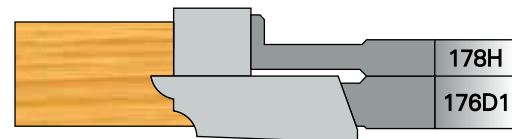
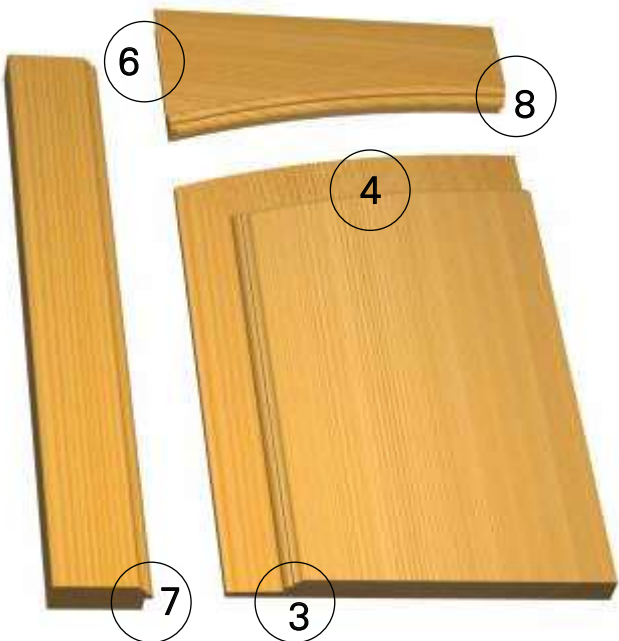

6

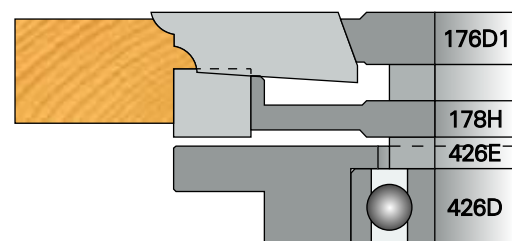

7 + 8



**HW**

**MAN**

D 160 n 4800 - 7100  
D 180 n 4300 - 6300

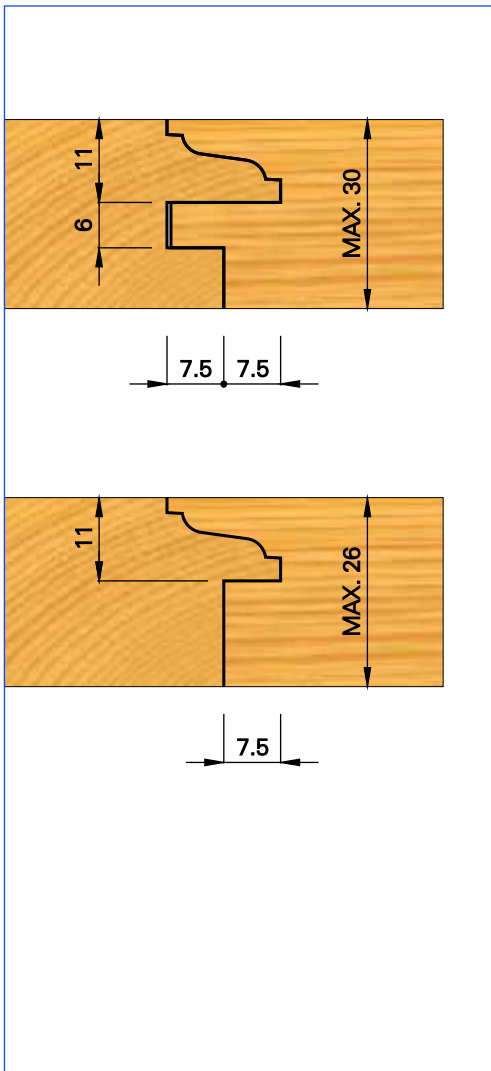
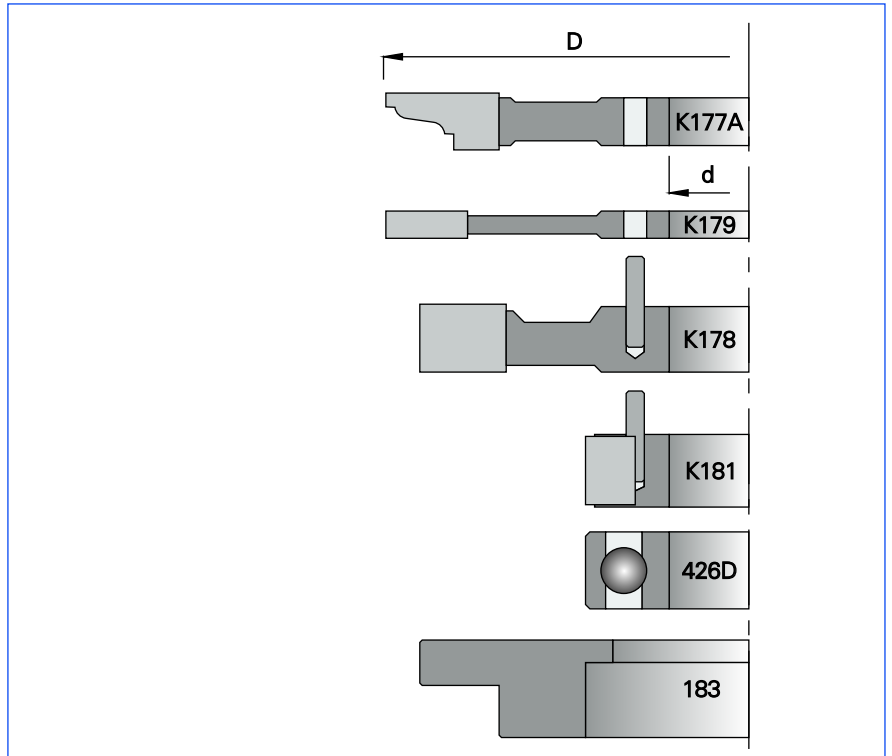

### SET COMPLETO.

D	d	Z	COD. SET
160	30	2	K1770030HW
160	35	2	K1770035HW
180	40	2	K1770040HW
180	50	2	K1770050HW

ART.	D	d 30 COD.	d 35 COD.
K177 - A	160	K177A030HW	K177A035HW
K179	160	K1790030HW	K1790035HW
K178	145	K1780030HW	K1780035HW
K181	72	K1810030HW	K1810035HW
426 - D	72	0426D00030	0426D00035
183	145	0183000030	0183000035

ART.	D	d 40 COD.	d 50 COD.
K177 - A	180	K177A040HW	K177A050HW
K179	180	K1790040HW	K1790050HW
K178	165	K1780040HW	K1780050HW
K181	90	K1810040HW	K1810050HW
426 - D	90	0426D00040	0426D00050
183	165	0183000040	0183000050



Cutter set for furniture doors.



Juego de fresas para puertas de muebles.



Jeu de fraises pour moulure, contre - profil et plate - bande.



Fräsersatz für Abplatte, Profil und Konterprofil.

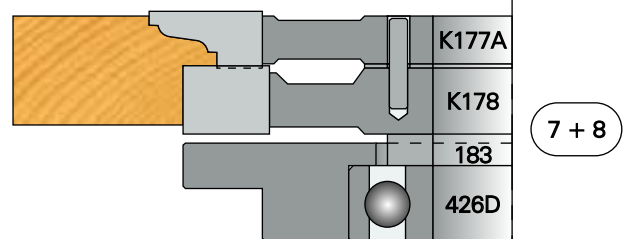
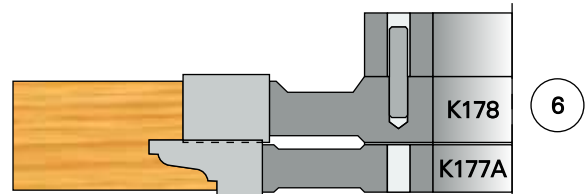
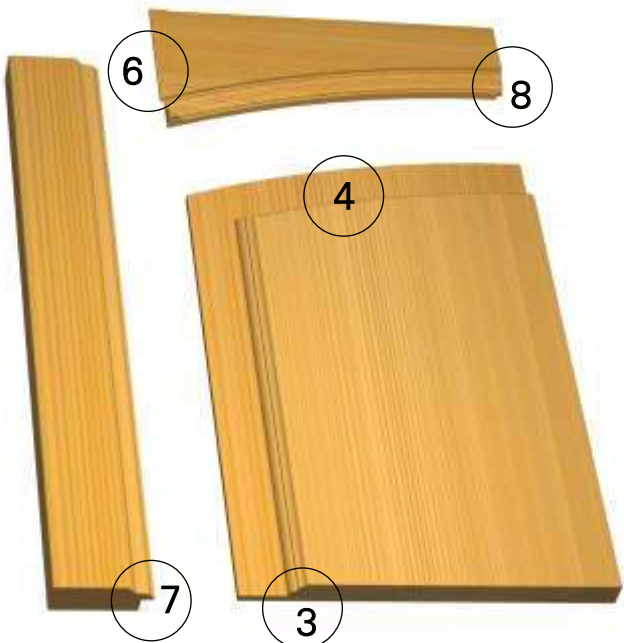
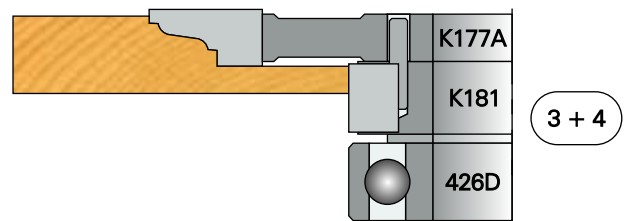
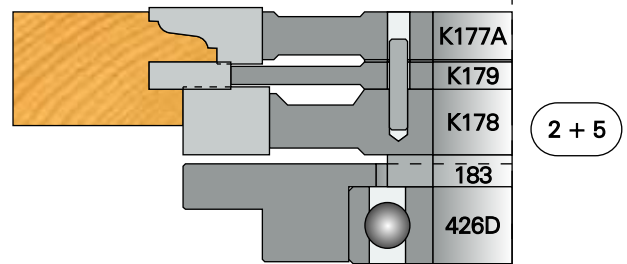
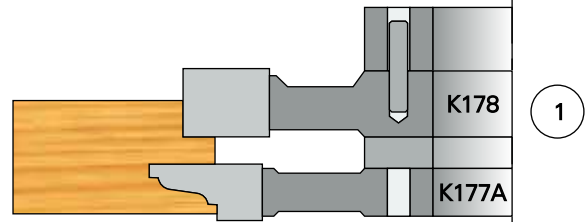
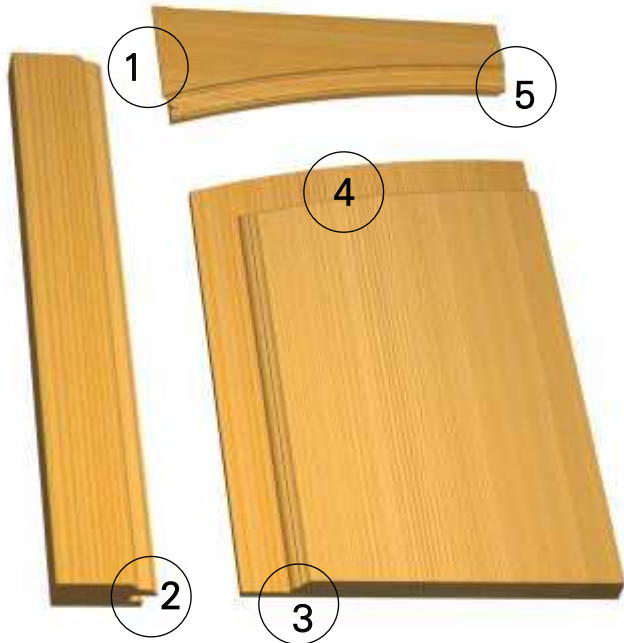

# Teste con inserti reversibili



Cutter heads with turnover knives.



Cabezales con cuchillas reversibles.



Porte - outils avec plaquettes réversibles.



Messerköpfe mit Wendeplatten.



ART. K 409



4.2



ART. K 408 - A



4.3

ART. K 408 - B



4.4

ART. K 408 - C



4.5



ART. K 408 - D



4.6

ART. K 408 - E



4.7

ART. K 408 - F



4.8



ART. K 417 - T



4.9

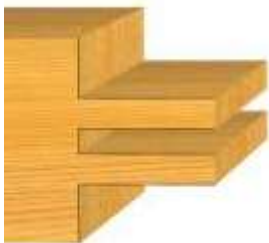

ART. K 432 R/S/T



4.10

ART. K 432 - 1



4.11

ART. K 429 - 1/4



4.12



ART. 384



4.16

ART. 386



4.18

ART. 415 - E



4.20



 Cutter heads with turnover knives.	 Cabezales con cuchillas reversibles.
 Porte - outils avec plaquettes réversibles.	 Messerköpfe mit Wendeplatten.



ART. 417 - A



4.21

ART. K 414



4.24

ART. K 416



4.25



ART. 415 - R



4.26



ART. K 410



4.27



ART. K 419 - B



4.28



ART. 417 - R



4.22

ART. K 424 - B1



4.29

ART. K 424 - B2



4.30



ART. K 418 - 2



4.31

ART. K 418 - 4



4.32

ART. K 419 - A



4.34



ART. K 420



4.35

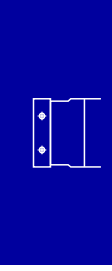

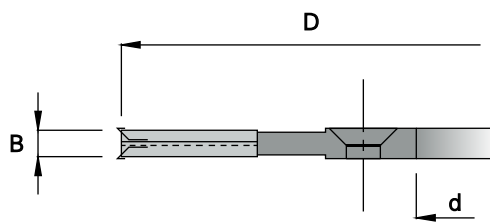

**HW**

**MAN**

n 7700 - 13300

D	B	d	Z	V	COD.
100	4	22	4	4	K409100422

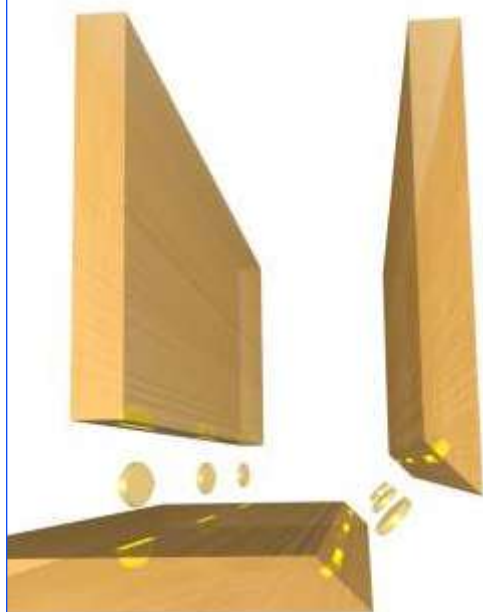

### Ricambi / Spare parts / Rechanges / Repuestos / Ersatzteile



COD.

048020A000



COD.

048020B000



COD.

048020C000



COD.

048020D000



COD.

048020E000

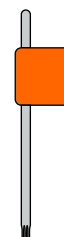

COD.

048020F000



Cutter head for thin grooves.



Cabezal para runaras delgadas.



Porte - outil pour rainures minces.



Messerkopf für dünne Nut.

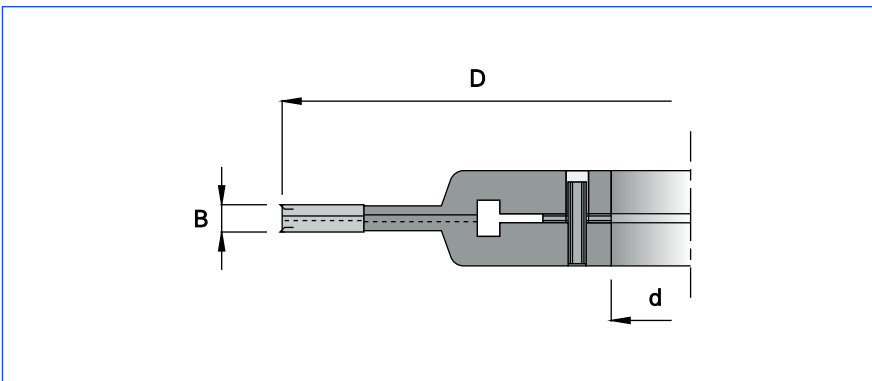

**HW**

**MAN**

D 140 n 5500 - 9500  
D 180 n 4300 - 7400

D	B	d	T	Z	V	COD.
140	4:7.5	30	22	8	4	K408140430
140	4:7.5	31.75	22	8	4	K408140431
140	4:7.5	35	22	8	4	K408140435
140	4:7.5	40	22	8	4	K408140440
140	4:7.5	50	22	8	4	K408140450
180	4:7.5	30	33	8	4	K408180430
180	4:7.5	31.75	33	8	4	K408180431
180	4:7.5	35	33	8	4	K408180435
180	4:7.5	40	33	8	4	K408180440
180	4:7.5	50	33	8	4	K408180450



Ricambi / Spare parts / Rechanges / Repuestos / Ersatzteile



COD.

048020A000



COD.

048020B000



COD.

048020C000



COD.

048020D000



COD.

048020E000

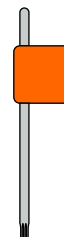

COD.

048020F000

Adjustable grooving cutter head.

Porte - outils à rainier extensibles.

Cabezal para ranurar extensible.

Verstellbar Nutmesserkopf.



# K 408 - B

## Teste per incastri regolabili con anelli

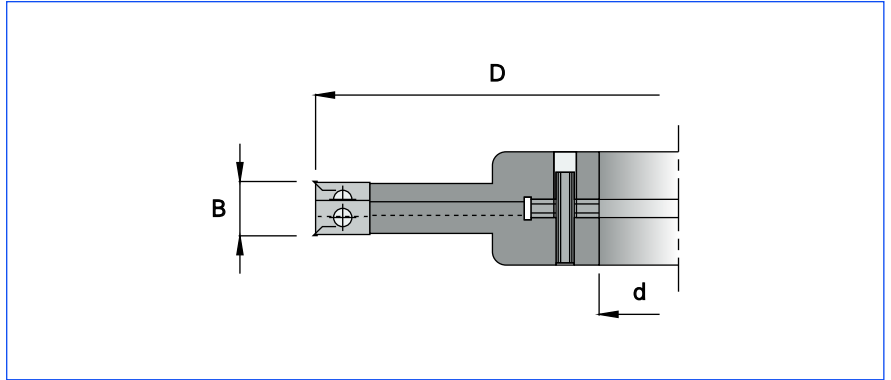

**HW**

**MAN**

D 140 n 5500 - 9500  
 D 160 n 4800 - 8300  
 D 250 n 3100 - 5300

D	B	d	T	Z	V	COD.
140	8 : 15.5	30	27	4	4	K408140830
140	8 : 15.5	31.75	27	4	4	K408140831
140	8 : 15.5	35	27	4	4	K408140835
140	8 : 15.5	40	27	4	4	K408140840
160	8 : 15.5	30	37	4	4	K408160830
160	8 : 15.5	31.75	37	4	4	K408160831
160	8 : 15.5	35	37	4	4	K408160835
160	8 : 15.5	40	37	4	4	K408160840
160	8 : 15.5	50	31	4	4	K408160850
250	8 : 15.5	30	63	4	4	K408250830
250	8 : 15.5	31.75	63	4	4	K408250831
250	8 : 15.5	35	63	4	4	K408250835
250	8 : 15.5	40	63	4	4	K408250840
250	8 : 15.5	50	63	4	4	K408250850

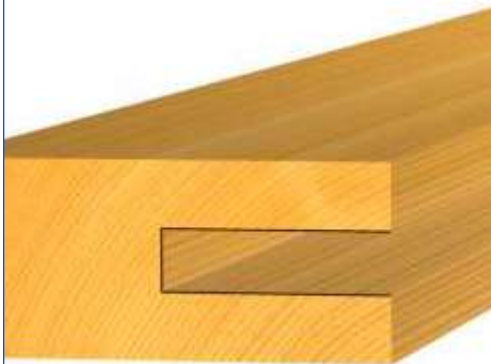

### Ricambi / Spare parts / Rechanges / Repuestos / Ersatzteile



COD.

COD.

COD.

0480030014

0480050007

0480500700



COD.

COD.

COD.

048060A000

0480700512

048074A507

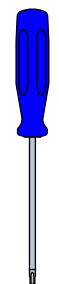
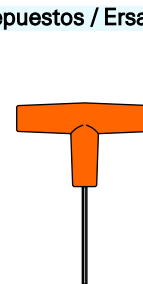

COD.

COD.

0480782500

048078T200



Adjustable grooving cutter head.



Cabezal para ranurar extensible.



Porte - outils à rainer extensibles.



Verstellbar Nutmesserkopf.

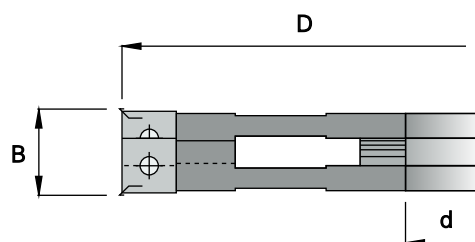

**HW**

**MAN**

D 140 n 5500 - 9500  
 D 160 n 4800 - 8300  
 D 250 n 3100 - 5300

D	B	d	T	Z	V	COD.
140	12.5:22	30	43	4	4	K408141230
140	12.5:22	31.75	43	4	4	K408141231
140	12.5:22	35	40	4	4	K408141235
140	12.5:22	40	38	4	4	K408141240
140	12.5:22	50	33	4	4	K408141250
160	12.5:22	30	53	4	4	K408161230
160	12.5:22	31.75	53	4	4	K408161231
160	12.5:22	35	50	4	4	K408161235
160	12.5:22	40	48	4	4	K408161240
160	12.5:22	50	43	4	4	K408161250
250	12.5:22	30	98	4	4	K408251230
250	12.5:22	31.75	98	4	4	K408251231
250	12.5:22	35	95	4	4	K408251235
250	12.5:22	40	93	4	4	K408251240
250	12.5:22	50	88	4	4	K408251250

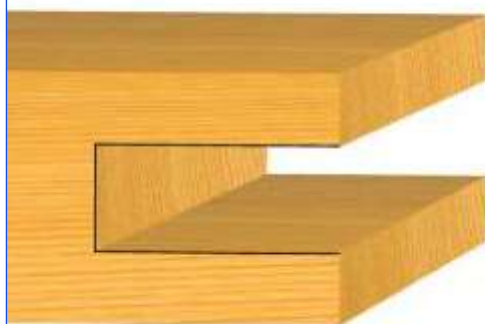

Ricambi / Spare parts / Rechanges / Repuestos / Ersatzteile



COD.

0480030014



COD.

0480050012



COD.

0480501000



COD.

048060B000



COD.

0480700512



COD.

048074A510

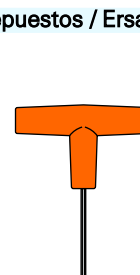

COD.

0480782500



COD.

048078T200

 Adjustable grooving cutter head.

 Cabezal para ranurar extensible.

 Porte - outils à rainer extensibles.

 Verstellbar Nutmesserkopf.

# K 408 - D

## Teste per incastri regolabili con anelli

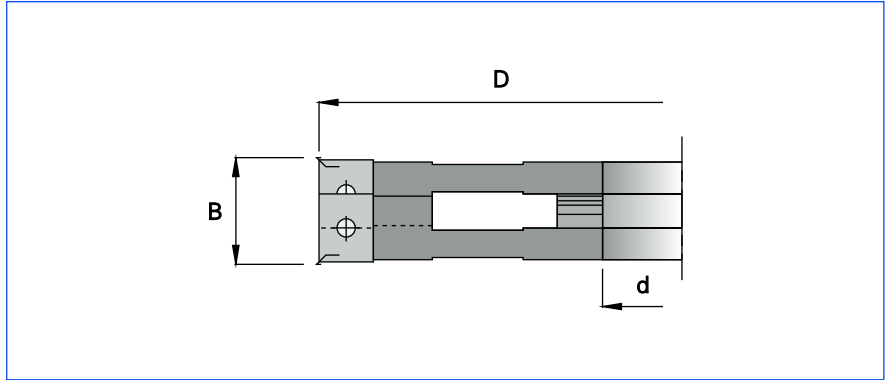

**HW**

**MAN**

D 140 n 5500 - 9500  
D 160 n 4800 - 8300

D	B	d	T	Z	V	COD.
140	16:27	30	43	4	4	K408141630
140	16:27	31.75	43	4	4	K408141631
140	16:27	35	40	4	4	K408141635
140	16:27	40	38	4	4	K408141640
140	16:27	50	33	4	4	K408141650
160	16:27	30	53	4	4	K408161630
160	16:27	31.75	53	4	4	K408161631
160	16:27	35	50	4	4	K408161635
160	16:27	40	48	4	4	K408161640
160	16:27	50	43	4	4	K408161650

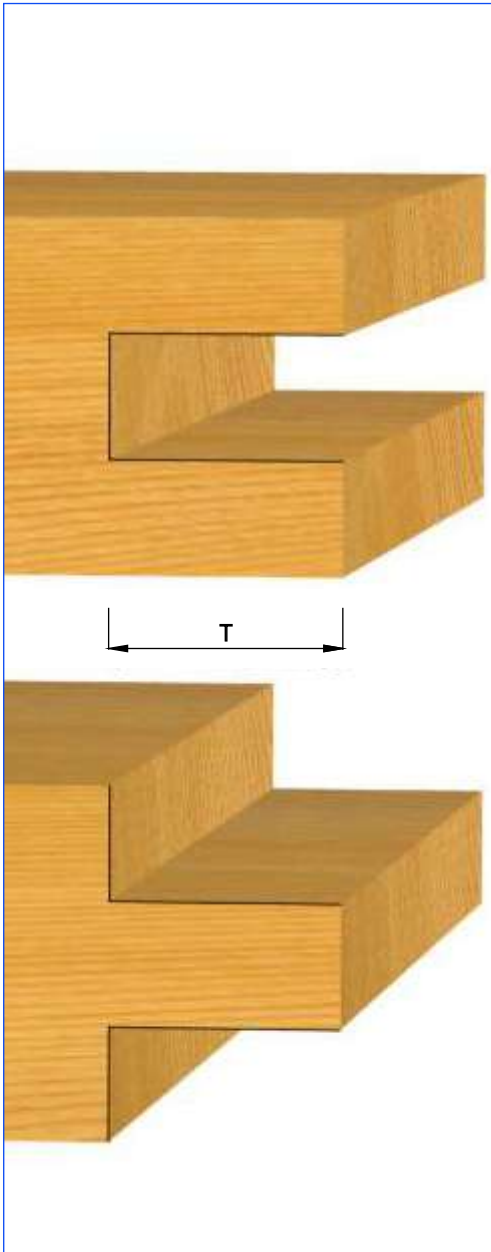

Ricambi / Spare parts / Rechanges / Repuestos / Ersatzteile

COD.	COD.	COD.		
0480030014	0480050015	0480501300		
COD.	COD.	COD.	COD.	COD.
048060C000	0480700612	048074A510	0480783000	048078T200

Adjustable grooving cutter head.

Cabezal para ranurar extensible.

Porte - outils à rainer extensibles.

Verstellbar Nutmesserkopf.

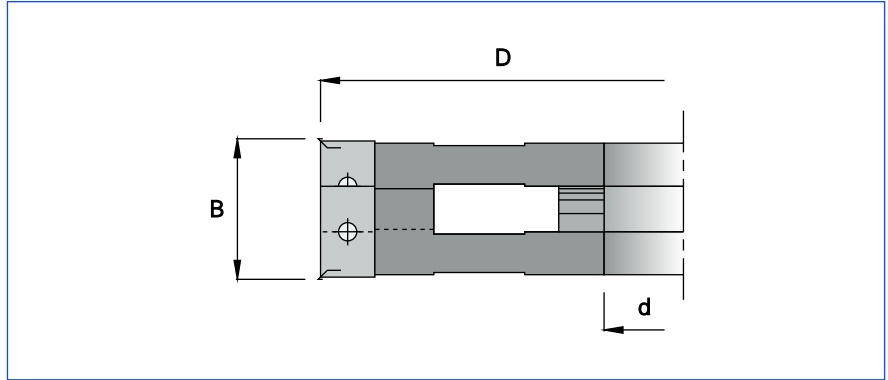

**HW**

**MAN**

D 140 n 5500 - 9500  
D 160 n 4800 - 8300

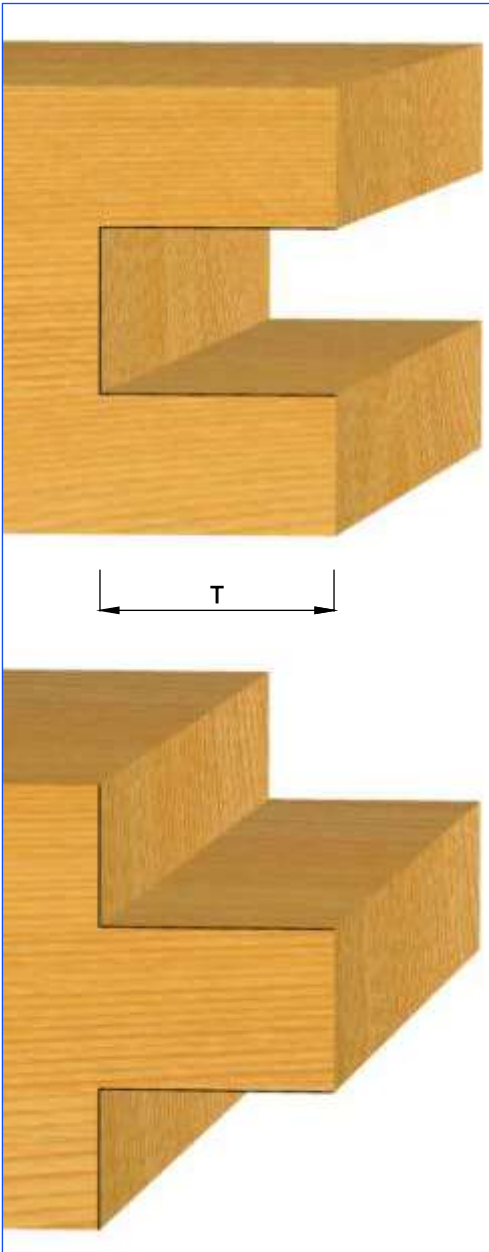

D	B	d	T	Z	V	COD.
140	21 : 37	30	43	4	4	K408142130
140	21 : 37	31.75	43	4	4	K408142131
140	21 : 37	35	40	4	4	K408142135
140	21 : 37	40	38	4	4	K408142140
140	21 : 37	50	33	4	4	K408142150
160	21 : 37	30	53	4	4	K408162130
160	21 : 37	31.75	53	4	4	K408162131
160	21 : 37	35	50	4	4	K408162135
160	21 : 37	40	48	4	4	K408162140
160	21 : 37	50	43	4	4	K408162150

### Ricambi / Spare parts / Rechanges / Repuestos / Ersatzteile

COD. 0480030014	COD. 0480050020	COD. 0480501800	COD. 0480783000	COD. 048078T200
COD. 048060C000	COD. 0480700612	COD. 048074A510		

Adjustable grooving cutter head.

Cabezal para ranurar extensible.

Porte - outils à rainier extensibles.

Verstellbar Nutmesserkopf.

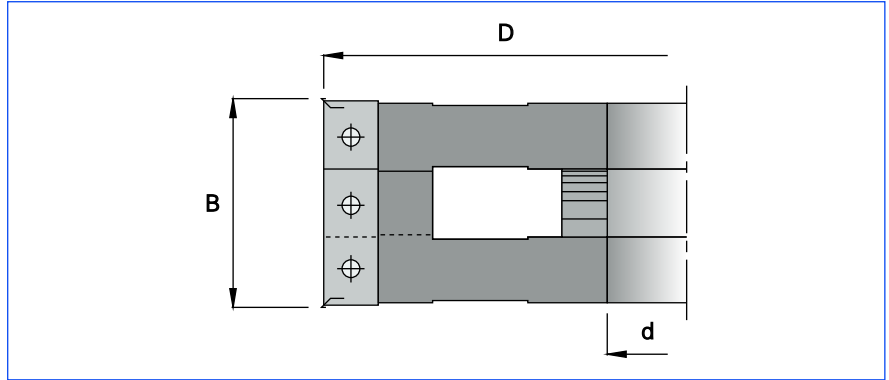
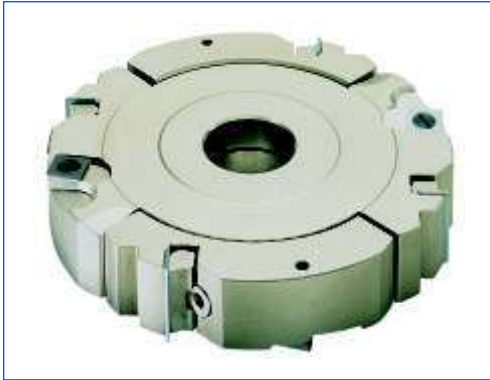

**HW**

**MAN**

D 140 n 5500 - 9500  
D 160 n 4800 - 8300

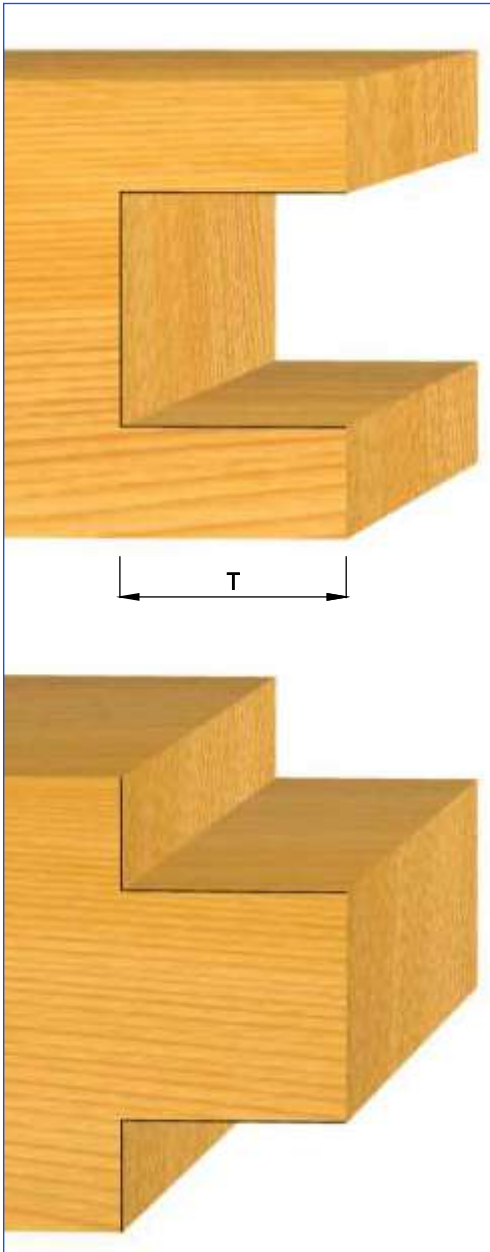

D	B	d	T	Z	V	COD.
140	31:57	30	43	4	4	K408143130
140	31:57	31.75	43	4	4	K408143131
140	31:57	35	40	4	4	K408143135
140	31:57	40	38	4	4	K408143140
140	31:57	50	33	4	4	K408143150
160	31:57	30	53	4	4	K408163130
160	31:57	31.75	53	4	4	K408163131
160	31:57	35	50	4	4	K408163135
160	31:57	40	48	4	4	K408163140
160	31:57	50	43	4	4	K408163150

**Ricambi / Spare parts / Rechanges / Repuestos / Ersatzteile**

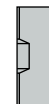
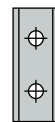

COD.

COD.

COD.

0480030014

0480050030

0480502600

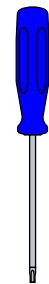
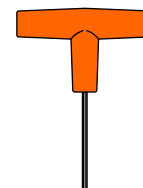

COD.

COD.

COD.

COD.

COD.

048060C000

0480700612

048074A510

0480783000

048078T200



Adjustable grooving cutter head.



Cabezal para ranurar extensible.



Porte - outils à rainer extensibles.



Verstellbar Nutmesserkopf.



**HW**

**MAN**

D 86 n 9000 - 12300  
D 100 n 7700 - 10500  
D 125 n 6200 - 8400

— corpo in lega leggera  
— taglio frazionato

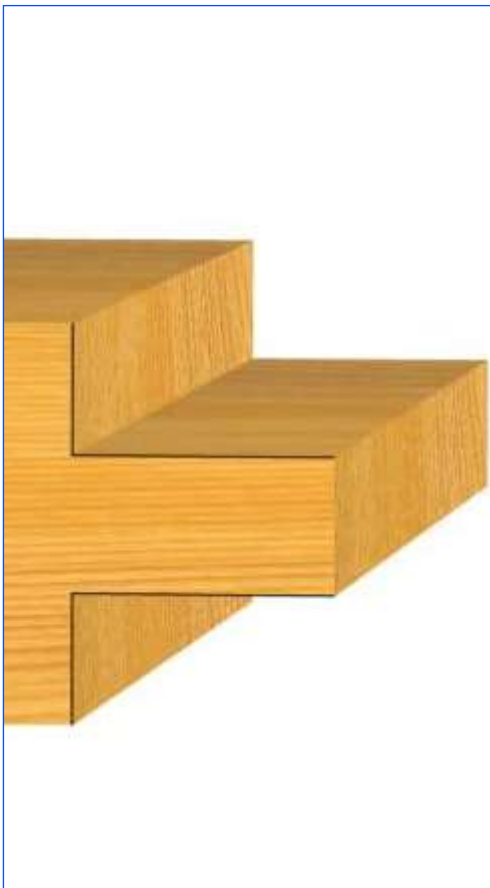
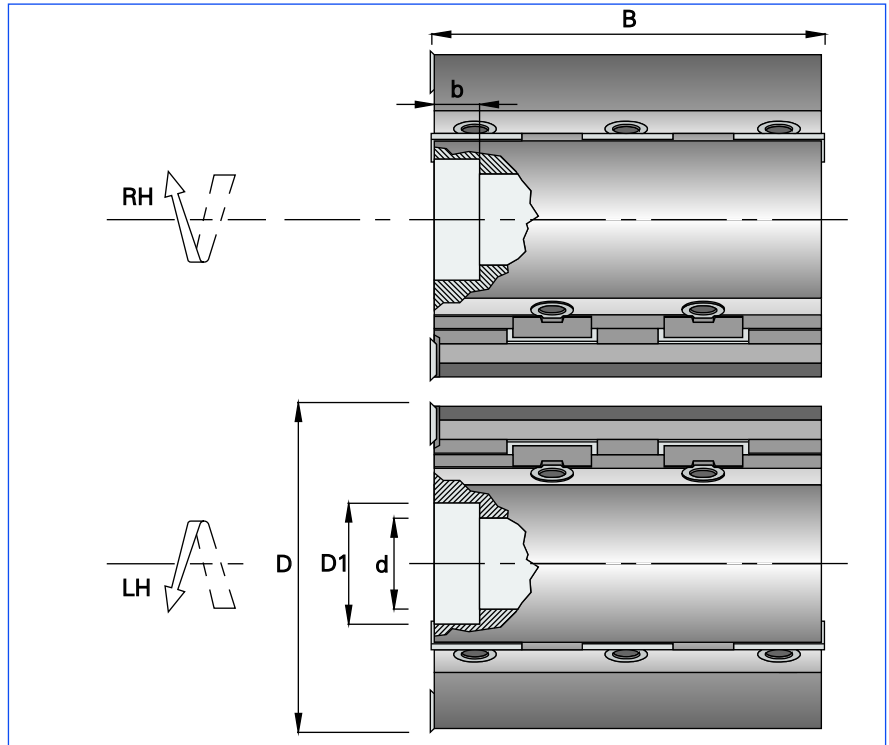

D	B	d	Z	V		COD. RH	COD. LH
86	100	25	2+2	4	8	K417T025RH	K417T025LH
100	100	30	2+2	4	8	K417T030RH	K417T030LH
100	120	25	2+2	4	10	K417T225RH	K417T225LH
125	130	25	2+2	4	10	K417T325RH	K417T325LH
125	130	30	2+2	4	10	K417T330RH	K417T330LH
125	130	35	2+2	4	10	K417T335RH	K417T335LH
125	150	25	2+2	4	12	K417T525RH	K417T525LH
125	150	30	2+2	4	12	K417T530RH	K417T530LH
125	150	35	2+2	4	12	K417T535RH	K417T535LH

Nelle ordinazioni indicare le quote " D1 " - " b " .

Ricambi / Spare parts / Rechanges / Repuestos / Ersatzteile

COD.	COD.	COD.	COD.	COD.
0480030014	0480050030	0480502600		
COD.	COD.	COD.	COD.	COD.
048060C000	0480700612	048074A510	0480783000	048078T200

Scribing heads for manual tenoning machines.  
Light alloy tool body.  
Fractional cut.  
When ordering state dimensions " D1 " and " b " .

Cabezales para maquina espigadora manual.  
Cuerpo de aleacion ligera.  
Corte fraccionado.  
En los pedidos indicar dimensiones " D1 " y " b " .

Porte - outils pour tenonneuse manuelle.  
Corps en alliage léger.  
Coupe fractionée.  
A la commande, indiquer dimensions " D1 " et " b " .

Messerköpfe für Zapfenmaschinen.  
Tragkörper aus Leichtmetall.  
Teilschnitt.  
Bei Bestellungen Abmessungen " D1 " und " b " angeben.

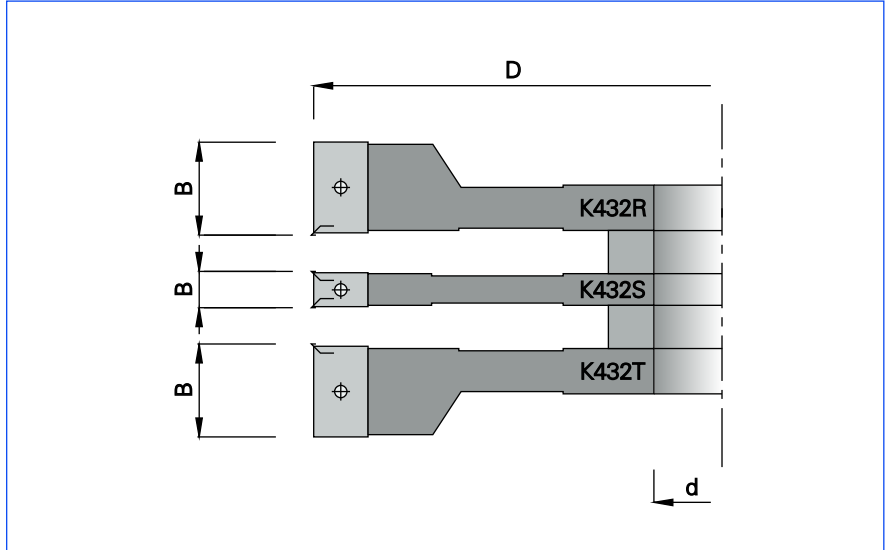

**HW** **MAN**

n 4300 - 7400

D	B	d	T	Z	V	COD.
180	20	30	64	2	2	K432R00030
180	8	30	64	2	4	K432S08030
180	20	30	64	2	2	K432T00030

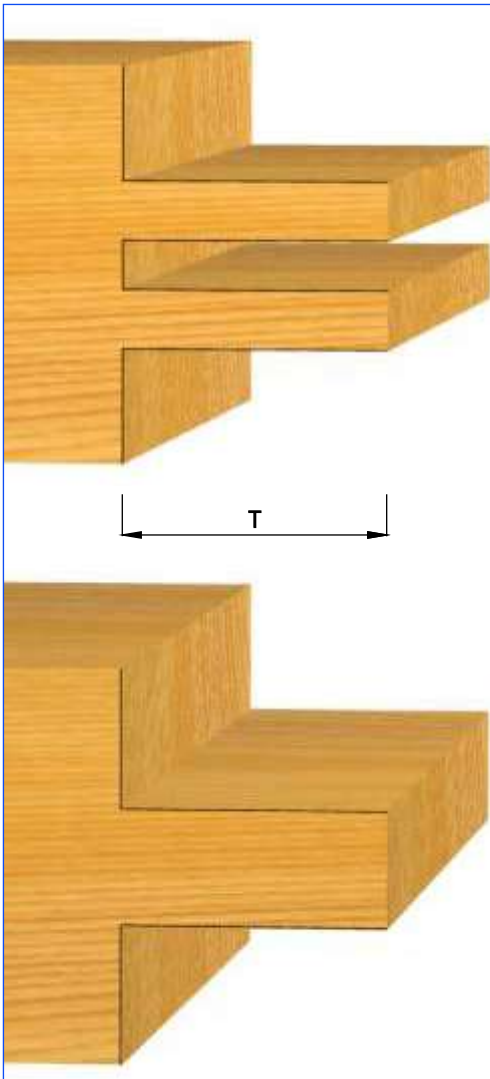

**Ricambi / Spare parts / Rechanges / Repuestos / Ersatzteile**

COD.	COD.	COD.	COD.	COD.	COD.	COD.
0480030014	0480050007	0480050020	0480500700	0480501800	048060A000	048060C000

COD.	COD.	COD.	COD.	COD.	COD.	COD.
0480700512	0480700612	048074A507	048074A510	0480782500	0480783000	048078T200

Tenoning cutter head set.	Juego de cabezales para espigar.
Jeu de porte - outils à tenonner.	Messerkopfsatz für Zapfenprofil.

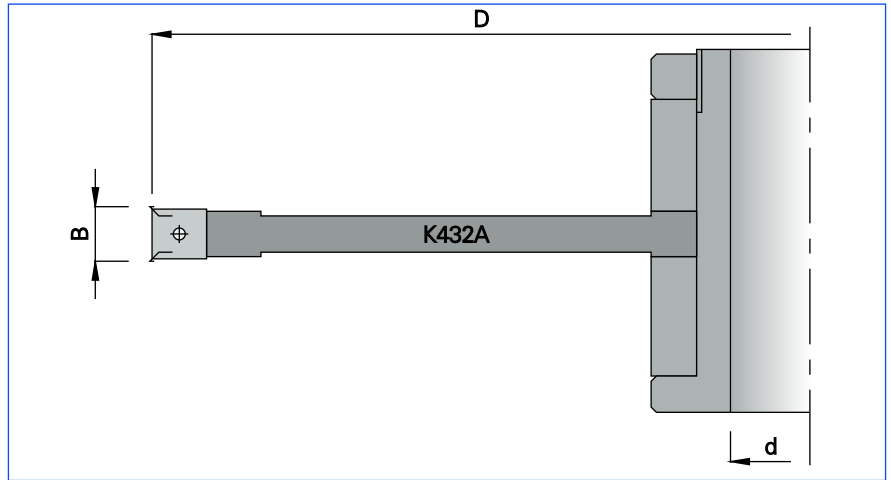

**HW**

**MAN**

n 2700 - 4600

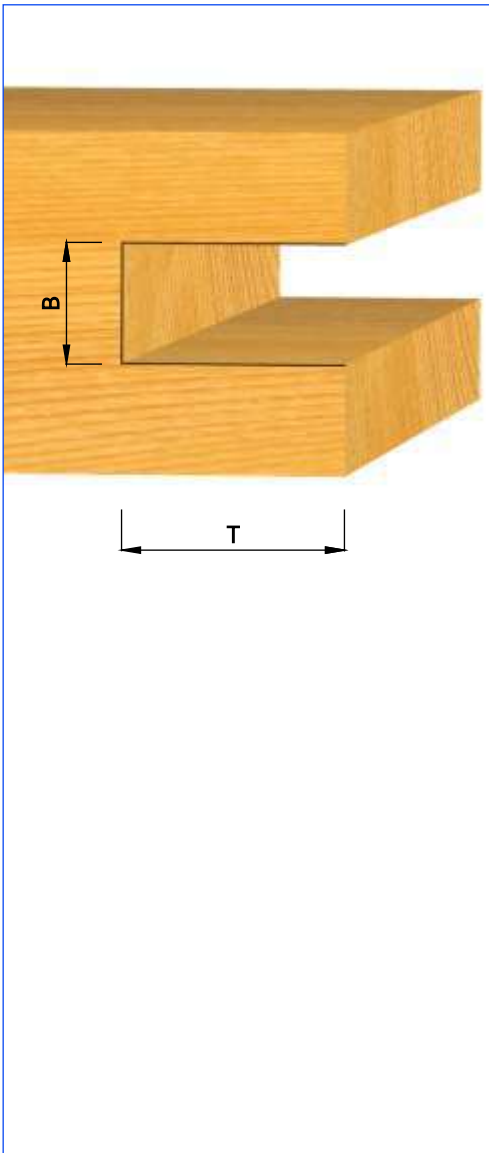

D	B	d	T	Z	V	COD.
290	8	30	104	4	4	K432010830
290	8	31.75	104	4	4	K432010831
290	8	35	104	4	4	K432010835
290	8	40	104	4	4	K432010840
290	8	50	104	4	4	K432010850
290	9	30	104	4	4	K432010930
290	9	31.75	104	4	4	K432010931
290	9	35	104	4	4	K432010935
290	9	40	104	4	4	K432010940
290	9	50	104	4	4	K432010950
290	10	30	104	4	4	K432011030
290	10	31.75	104	4	4	K432011031
290	10	35	104	4	4	K432011035
290	10	40	104	4	4	K432011040
290	10	50	104	4	4	K432011050
290	12	30	104	4	4	K432011230
290	12	31.75	104	4	4	K432011231
290	12	35	104	4	4	K432011235
290	12	40	104	4	4	K432011240
290	12	50	104	4	4	K432011250
290	14	30	104	4	4	K432011430
290	14	31.75	104	4	4	K432011431
290	14	35	104	4	4	K432011435
290	14	40	104	4	4	K432011440
290	14	50	104	4	4	K432011450
290	16	30	104	4	4	K432011630
290	16	31.75	104	4	4	K432011631
290	16	35	104	4	4	K432011635
290	16	40	104	4	4	K432011640
290	16	50	104	4	4	K432011650
290	18	30	104	4	4	K432011830
290	18	31.75	104	4	4	K432011831
290	18	35	104	4	4	K432011835
290	18	40	104	4	4	K432011840
290	18	50	104	4	4	K432011850

 Sleeved slotting cutter heads.

 Cabezales para almillar con casquillo.

 Porte - outils à enfourchement sur manchon.

 Schlitz - Scheibenkopf auf Buechse.



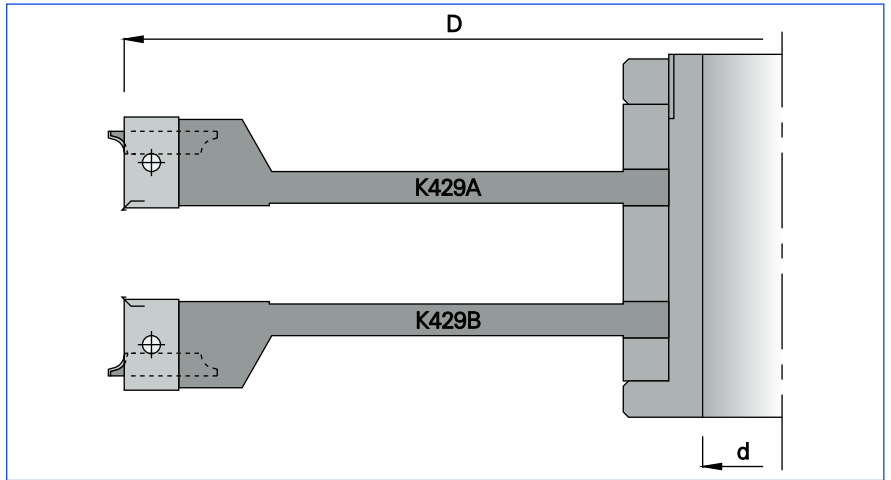



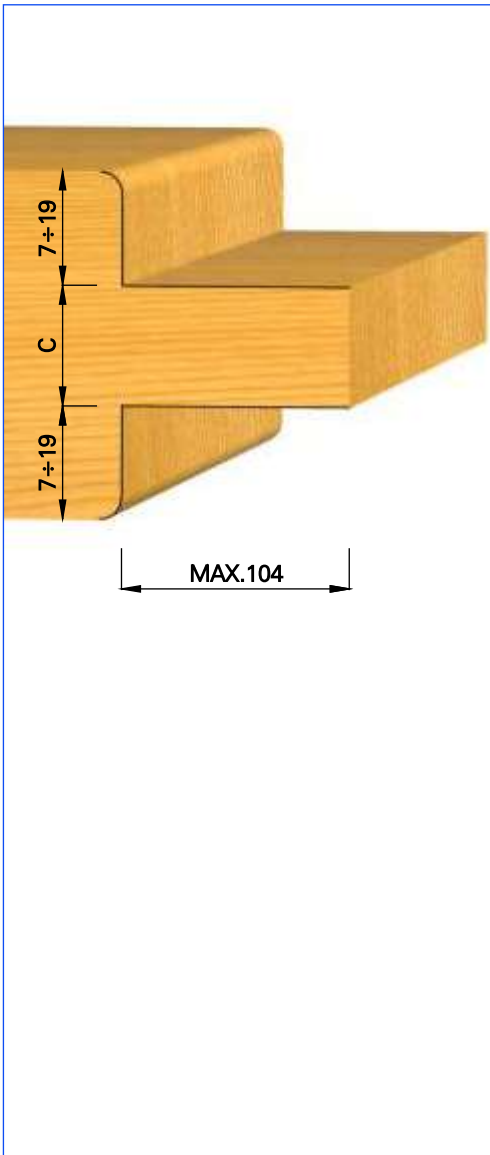

HW

MAN

n 2700 - 4600



D	C	d	Z	COD.			
					45°	R 1.5	R 3
D	C	d	Z	COD.	COD.	COD.	COD.
290	8	30	4	K429183000	K429183045	K4291830R1	K4291830R3
290	8	31.75	4	K429183100	K429183145	K4291831R1	K4291831R3
290	8	35	4	K429183500	K429183545	K4291835R1	K4291835R3
290	8	40	4	K429184000	K429184045	K4291840R1	K4291840R3
290	8	50	4	K429185000	K429185045	K4291850R1	K4291850R3
290	9	30	4	K429193000	K429193045	K4291930R1	K4291930R3
290	9	31.75	4	K429193100	K429193145	K4291931R1	K4291931R3
290	9	35	4	K429193500	K429193545	K4291935R1	K4291935R3
290	9	40	4	K429194000	K429194045	K4291940R1	K4291940R3
290	9	50	4	K429195000	K429195045	K4291950R1	K4291950R3
290	10	30	4	K429103000	K429103045	K4291030R1	K4291030R3
290	10	31.75	4	K429103100	K429103145	K4291031R1	K4291031R3
290	10	35	4	K429103500	K429103545	K4291035R1	K4291035R3
290	10	40	4	K429104000	K429104045	K4291040R1	K4291040R3
290	10	50	4	K429105000	K429105045	K4291050R1	K4291050R3
290	12	30	4	K429123000	K429123045	K4291230R1	K4291230R3
290	12	31.75	4	K429123100	K429123145	K4291231R1	K4291231R3
290	12	35	4	K429123500	K429123545	K4291235R1	K4291235R3
290	12	40	4	K429124000	K429124045	K4291240R1	K4291240R3
290	12	50	4	K429125000	K429125045	K4291250R1	K4291250R3
290	14	30	4	K429143000	K429143045	K4291430R1	K4291430R3
290	14	31.75	4	K429143100	K429143145	K4291431R1	K4291431R3
290	14	35	4	K429143500	K429143545	K4291435R1	K4291435R3
290	14	40	4	K429144000	K429144045	K4291440R1	K4291440R3
290	14	50	4	K429145000	K429145045	K4291450R1	K4291450R3
290	16	30	4	K429163000	K429163045	K4291630R1	K4291630R3
290	16	31.75	4	K429163100	K429163145	K4291631R1	K4291631R3
290	16	35	4	K429163500	K429163545	K4291635R1	K4291635R3
290	16	40	4	K429164000	K429164045	K4291640R1	K4291640R3
290	16	50	4	K429165000	K429165045	K4291650R1	K4291650R3
290	18	30	4	K429173000	K429173045	K4291730R1	K4291730R3
290	18	31.75	4	K429173100	K429173145	K4291731R1	K4291731R3
290	18	35	4	K429173500	K429173545	K4291735R1	K4291735R3
290	18	40	4	K429174000	K429174045	K4291740R1	K4291740R3
290	18	50	4	K429175000	K429175045	K4291750R1	K4291750R3



Set of tenoning cutter heads.



Juego de cabezales para espigar.



Jeu de porte - outils à tenonner.



Zapfenkopfsatz.



HW

MAN

n 2700 - 4600

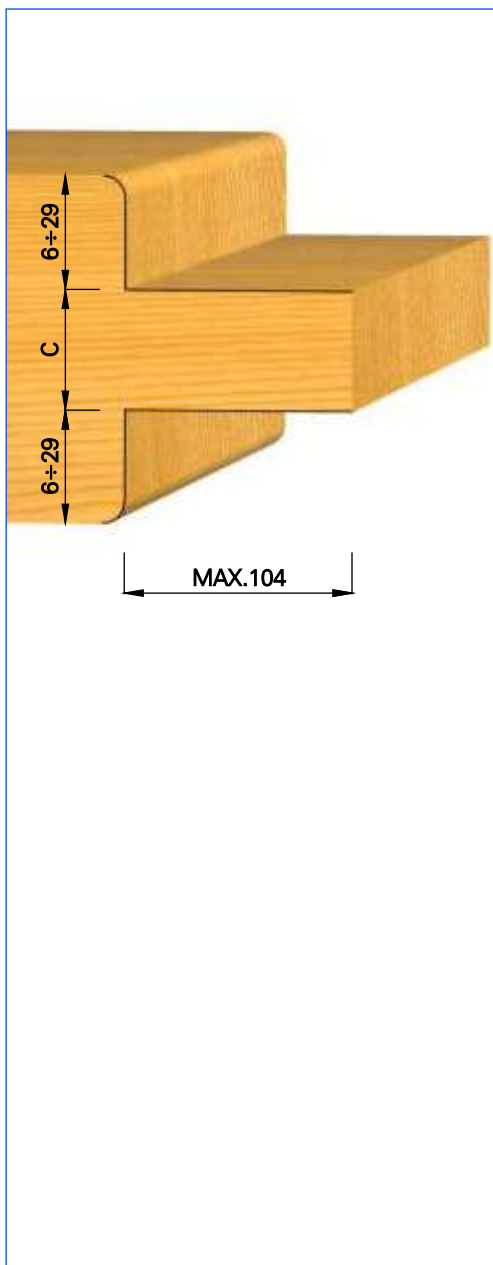
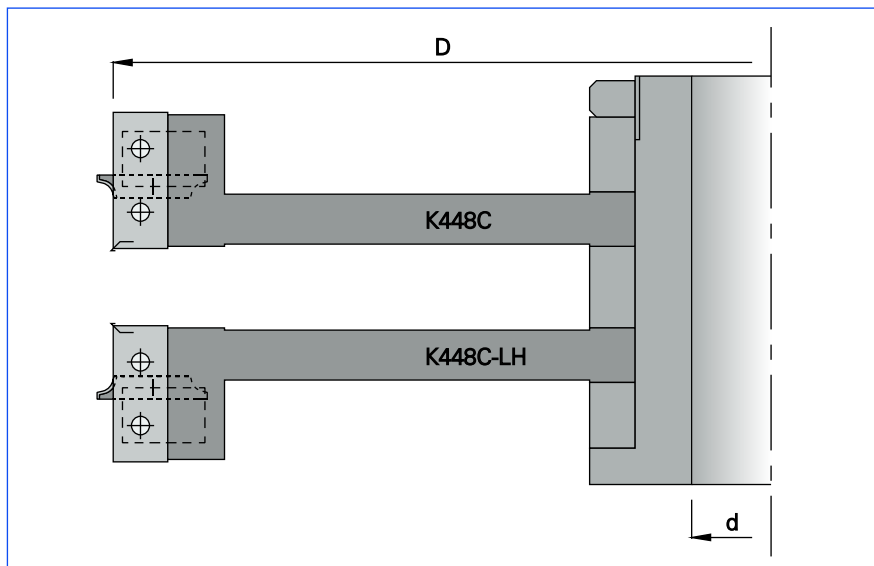

D	C	d	Z	COD.	45° COD.	R 3 COD.	R 5 COD.
290	8	30	4	K429483000	K429483045	K4294830R3	K4294830R5
290	8	31.75	4	K429483100	K429483145	K4294831R3	K4294831R5
290	8	35	4	K429483500	K429483545	K4294835R3	K4294835R5
290	8	40	4	K429484000	K429484045	K4294840R3	K4294840R5
290	8	50	4	K429485000	K429485045	K4294850R3	K4294850R5
290	9	30	4	K429493000	K429493045	K4294930R3	K4294930R5
290	9	31.75	4	K429493100	K429493145	K4294931R3	K4294931R5
290	9	35	4	K429493500	K429493545	K4294935R3	K4294935R5
290	9	40	4	K429494000	K429494045	K4294940R3	K4294940R5
290	9	50	4	K429495000	K429495045	K4294950R3	K4294950R5
290	10	30	4	K429403000	K429403045	K4294030R3	K4294030R5
290	10	31.75	4	K429403100	K429403145	K4294031R3	K4294031R5
290	10	35	4	K429403500	K429403545	K4294035R3	K4294035R5
290	10	40	4	K429404000	K429404045	K4294040R3	K4294040R5
290	10	50	4	K429405000	K429405045	K4294050R3	K4294050R5
290	12	30	4	K429423000	K429423045	K4294230R3	K4294230R5
290	12	31.75	4	K429423100	K429423145	K4294231R3	K4294231R5
290	12	35	4	K429423500	K429423545	K4294235R3	K4294235R5
290	12	40	4	K429424000	K429424045	K4294240R3	K4294240R5
290	12	50	4	K429425000	K429425045	K4294250R3	K4294250R5
290	14	30	4	K429443000	K429443045	K4294430R3	K4294430R5
290	14	31.75	4	K429443100	K429443145	K4294431R3	K4294431R5
290	14	35	4	K429443500	K429443545	K4294435R3	K4294435R5
290	14	40	4	K429444000	K429444045	K4294440R3	K4294440R5
290	14	50	4	K429445000	K429445045	K4294450R3	K4294450R5
290	16	30	4	K429463000	K429463045	K4294630R3	K4294630R5
290	16	31.75	4	K429463100	K429463145	K4294631R3	K4294631R5
290	16	35	4	K429463500	K429463545	K4294635R3	K4294635R5
290	16	40	4	K429464000	K429464045	K4294640R3	K4294640R5
290	16	50	4	K429465000	K429465045	K4294650R3	K4294650R5
290	18	30	4	K429473000	K429473045	K4294730R3	K4294730R5
290	18	31.75	4	K429473100	K429473145	K4294731R3	K4294731R5
290	18	35	4	K429473500	K429473545	K4294735R3	K4294735R5
290	18	40	4	K429474000	K429474045	K4294740R3	K4294740R5
290	18	50	4	K429475000	K429475045	K4294750R3	K4294750R5

 Set of tenoning cutter heads.

 Juego de cabezales para espigar.

 Jeu de porte - outils à tenonner.

 Zapfenkopfsatz.

# K 432 - 1

## Ricambi per K 432 - 1



Ricambi / Spare parts / Rechanges / Repuestos / Ersatzteile

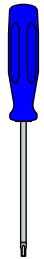
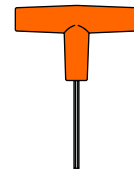

B	COD.	COD.	COD.	COD.	COD.	COD.	COD.	COD.
8	0480030014	0480050007	0480500700	048060A000	0480700512	048074A507	0480782500	048078T200
9	0480030014	0480050007	0480500700	048060A000	0480700512	048074A507	0480782500	048078T200
10	0480030014	0480050009	0480500700	048060A000	0480700512	048074A507	0480782500	048078T200
12	0480030014	0480050011	0480501000	048060B000	0480700512	048074A510	0480782500	048078T200
14	0480030014	0480050012	0480501000	048060B000	0480700512	048074A510	0480782500	048078T200
16	0480030014	0480050015	0480501300	048060C000	0480700612	048074A510	0480783000	048078T200
18	0480030014	0480050015	0480501300	048060C000	0480700612	048074A510	0480783000	048078T200

# K 429 - 1

## Ricambi per K 429 - 1 / K 429 - 4



Ricambi / Spare parts / Rechanges / Repuestos / Ersatzteile

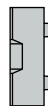
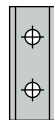

COD.	COD.	COD.	COD.	COD.	COD.	COD.	COD.	COD.	COD.
0480030014	0480050020	0480050030	0480501800	0480502600	048060C000	0480700612	0480700620	048074A510	048074B515

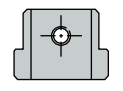
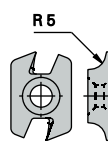
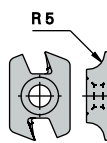
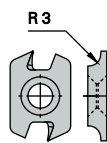
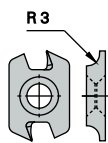
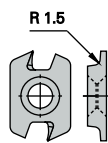
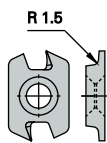
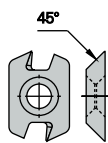
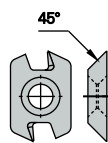

(45°-R1.5-R3)

COD.	COD.	COD.	COD.	COD.	COD.	COD.	COD.	COD.	COD.
048074C516	K480110000	K480120000	K480130000	K480140000	K480150000	K480160000	K48015R500	K48016R500	K48062E000

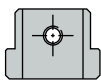

(R5)

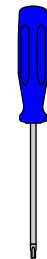
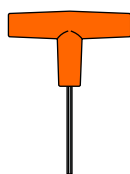

COD.	COD.	COD.
K48062ER50	0480783000	048078T200



Spare parts for K432 - K429.



Repuestos para K432 - K429.



Rechanges pour K432 - K429.



Ersatzteile K432 - K429.



# OMAS

YOUR BEST EQUIPMENT

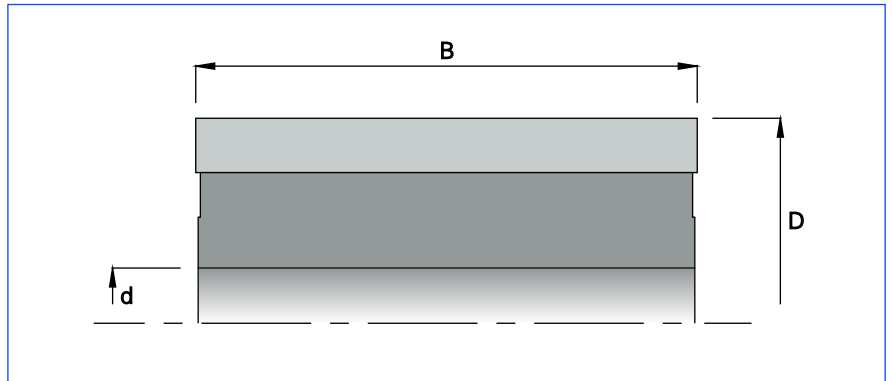

**HS - HW****MEC**

D 100 n max 7000  
D 125 n max 6000

- corpo in lega leggera
- completa di coltelli in HS mm 3 riaffilabili
- disponibile, su richiesta, con coltelli in HW mm 3



D	B	d	Z	COD.
100	120	35	3	0384101235
100	190	35	3	0384101935
125	60	40	4	0384120640
125	80	40	4	0384120840
125	100	40	4	0384121040
125	120	40	4	0384121240
125	130	40	4	0384121340
125	140	40	4	0384121440
125	150	40	4	0384121540
125	170	40	4	0384121740
125	180	40	4	0384121840
125	190	40	4	0384121940
125	210	40	4	0384122140
125	230	40	4	0384122340
125	240	40	4	0384122440
125	250	40	4	0384122540



Planing head.  
Light alloy tool body.  
Supplied with 3 mm HS knives to be re - sharpened.  
Available, upon request, with 3 mm carbide knives.



Cabezal para cepillar.  
Cuerpo de aleacion leggera.  
Equipado con cuchillas reafilables de HS mm 3.  
Disponible sobre demanda con cuchillas de metal duro mm 3.



Porte - outil à raboter.  
Corps en alliage léger.  
Fourni avec couteaux affutables en HS de 3 mm.  
Disponible, sur demande, avec couteaux de 3 mm en carbure.



Hobelmesserkopf.  
Tragkörper in Leichtmetall.  
Komplett mit HS mm 3 schleifbaren Hobelmessern.  
Lieferbar, auf Verlangen, mit mm 3 HW - Hobelmessern.



## Ricambi / Spare parts / Rechanges / Repuestos / Ersatzteile

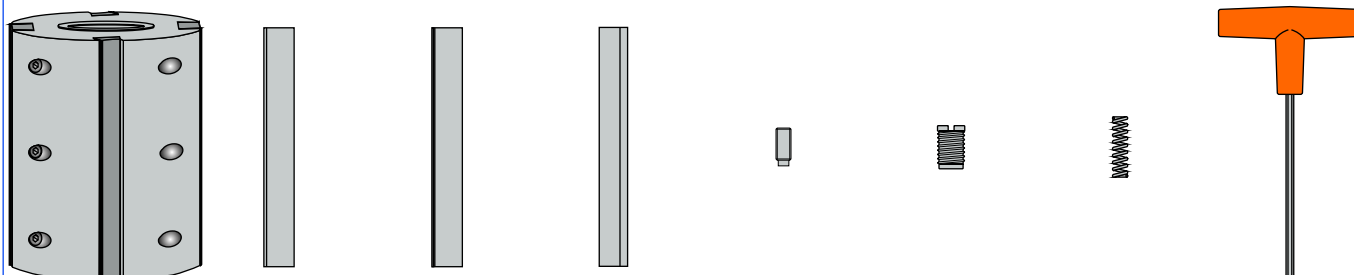

COD.	Coltello HS HS knife	Coltello HW HW knife	Cuneo di serraggio Clamping wedge	COD.	COD.	COD.	COD.
0384101235	03671225HS	03671225HW	048050P120	0480700820	048073BFM8	048073M617	048078L400
0384101935	03671925HS	03671925HW	048050P190	0480700820	048073BFM8	048073M617	048078L400
0384120640	03670630HS	03670630HW	048050P060	0480700820	048073BFM8	048073M617	048078L400
0384120840	03670830HS	03670830HW	048050P080	0480700820	048073BFM8	048073M617	048078L400
0384121040	03671030HS	03671030HW	048050P100	0480700820	048073BFM8	048073M617	048078L400
0384121240	03671230HS	03671230HW	048050P120	0480700820	048073BFM8	048073M617	048078L400
0384121340	03671330HS	03671330HW	048050P130	0480700820	048073BFM8	048073M617	048078L400
0384121440	03671430HS	03671430HW	048050P140	0480700820	048073BFM8	048073M617	048078L400
0384121540	03671530HS	03671530HW	048050P150	0480700820	048073BFM8	048073M617	048078L400
0384121740	03671730HS	03671730HW	048050P170	0480700820	048073BFM8	048073M617	048078L400
0384121840	03671830HS	03671830HW	048050P180	0480700820	048073BFM8	048073M617	048078L400
0384121940	03671930HS	03671930HW	048050P190	0480700820	048073BFM8	048073M617	048078L400
0384122140	03672130HS	03672130HW	048050P210	0480700820	048073BFM8	048073M617	048078L400
0384122340	03672330HS	03672330HW	048050P230	0480700820	048073BFM8	048073M617	048078L400
0384122440	03672430HS	03672430HW	048050P240	0480700820	048073BFM8	048073M617	048078L400
0384122540	03672530HS	03672530HW	048050P250	0480700820	048073BFM8	048073M617	048078L400

## 384 - C

## Coppia di calibri per teste art. 384

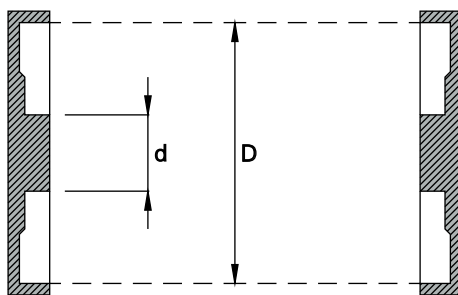

D	d	COD. (COPPIA / PAIR)
100	35	0384C10035
125	40	0384C12540
SPECIALE		0384CSPECI

 Setting gauge for planing heads art. 384

 Calibradores de ajuste para cabezales art. 384.

 Calibres de réglage pour porte - outils art. 384.

 Einstell - Lehre für Hobelmesserkopf art. 384.

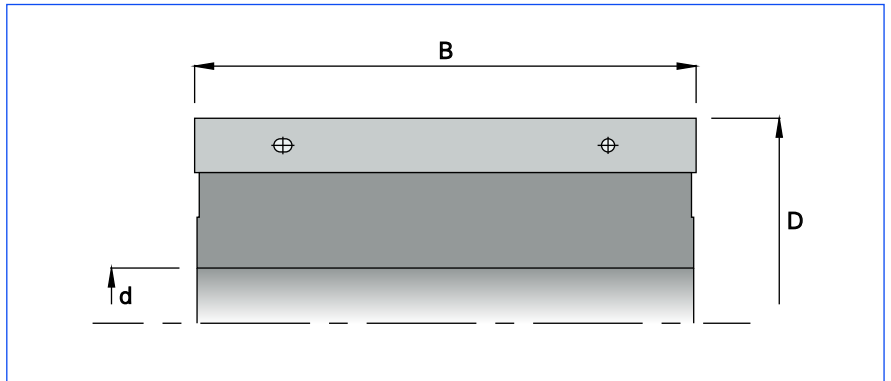
**HS****MEC**

D 100 n max 7500  
D 125 n max 7000

- corpo in lega leggera
- completa di coltelli reversibili in HS



D	B	d	Z	COD.
100	120	35	3	0386101235
100	190	35	3	0386101935
125	60	40	4	0386120640
125	80	40	4	0386120840
125	100	40	4	0386121040
125	120	40	4	0386121240
125	130	40	4	0386121340
125	140	40	4	0386121440
125	150	40	4	0386121540
125	170	40	4	0386121740
125	180	40	4	0386121840
125	190	40	4	0386121940
125	210	40	4	0386122140
125	230	40	4	0386122340



Planing head.  
Light alloy tool body.  
Supplied with HS turnover knives.



Cabezal para cepillar.  
Cuerpo de aleacion legera.  
Equipado con cuchillas reversibles de HS.



Porte - outil à raboter.  
Corps en alliage léger.  
Fourni avec couteaux réversibles en HS.



Hobelmesserkopf.  
Tragkörper in Leichtmetall.  
Komplett mit HS - Wendemesser.



Ricambi / Spare parts / Rechanges / Repuestos / Ersatzteile

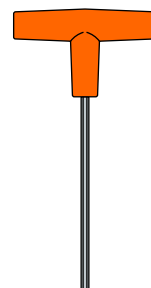
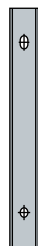
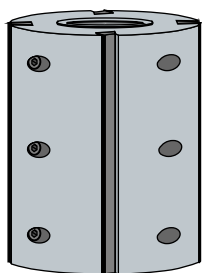

COD.	COD.	COD.	COD.	COD.	COD.
0386101235	0387C120HS	048050R120	0480700820	048073BFM8	048078L400
0386101935	0387C190HS	048050R190	0480700820	048073BFM8	048078L400
0386120640	0387C060HS	048050R060	0480700820	048073BFM8	048078L400
0386120840	0387C080HS	048050R080	0480700820	048073BFM8	048078L400
0386121040	0387C100HS	048050R100	0480700820	048073BFM8	048078L400
0386121240	0387C120HS	048050R120	0480700820	048073BFM8	048078L400
0386121340	0387C130HS	048050R130	0480700820	048073BFM8	048078L400
0386121440	0387C140HS	048050R140	0480700820	048073BFM8	048078L400
0386121540	0387C150HS	048050R150	0480700820	048073BFM8	048078L400
0386121740	0387C170HS	048050R170	0480700820	048073BFM8	048078L400
0386121840	0387C180HS	048050R180	0480700820	048073BFM8	048078L400
0386121940	0387C190HS	048050R190	0480700820	048073BFM8	048078L400
0386122140	0387C210HS	048050R210	0480700820	048073BFM8	048078L400
0386122340	0387C230HS	048050R230	0480700820	048073BFM8	048078L400

## 387 - C

### Coltelli per teste pialla art. 386

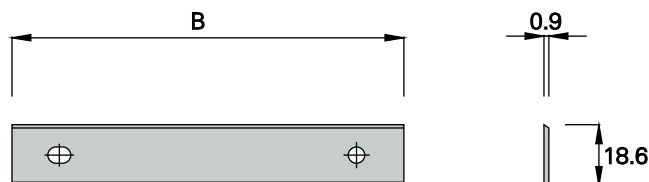

HS

B

COD.

60	0387C060HS
80	0387C080HS
100	0387C100HS
120	0387C120HS
130	0387C130HS
140	0387C140HS
150	0387C150HS
170	0387C170HS
180	0387C180HS
190	0387C190HS
200	0387C200HS
210	0387C210HS
230	0387C230HS

 HS turnover knives for planing heads art. 386.

 Cuchillas reversibles de HS para cabezales art. 386.

 Couteaux réversibles en HS pour porte - outils art. 386.

 HS - Wendemesser für Hobelmesserkopf art. 386.



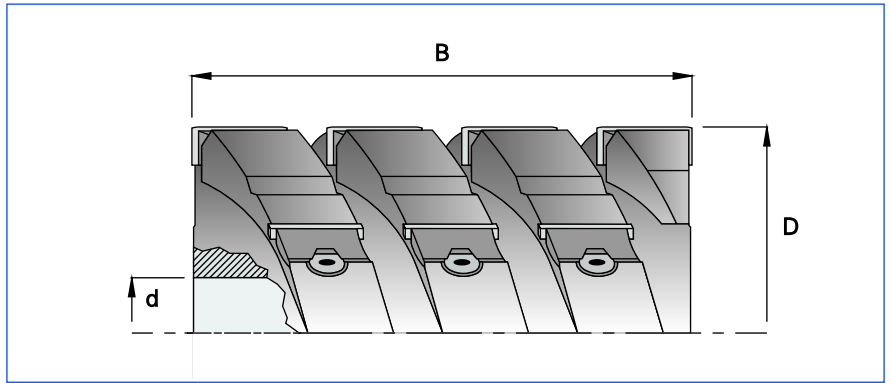
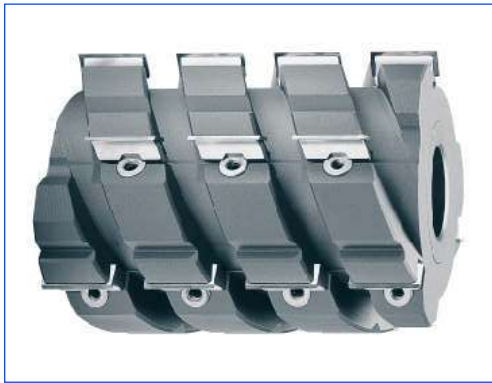

**HW**

**MEC**

D 100 n max 10500  
D 125 n max 8400

- corpo in lega leggera con scarichi elicoidali.
- inserti reversibili in HW arrotondati alle estremità per una migliore finitura.

D	B	d	Z		COD.
100	115	35	6	15	0415E11135
100	180	35	6	24	0415E11835
100	190	35	6	27	0415E11935
125	115	40	6	15	0415E21140
125	130	40	6	18	0415E21240
125	136	40	6	18	0415E21340
125	158	40	6	21	0415E21540
125	180	40	6	24	0415E21840
125	190	40	6	27	0415E21940
125	201	40	6	27	0415E22040
125	210	40	6	30	0415E22140
125	223	40	6	30	0415E22240
125	232	40	6	33	0415E22340
125	245	40	6	33	0415E22440
125	267	50	6	36	0415E22650



**Ricambi / Spare parts / Rechanges / Repuestos / Ersatzteile**

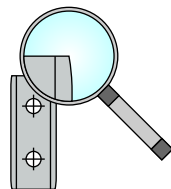

COD.

048015E300



COD.

04805715EC

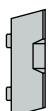

COD.

04805715EL



COD.

048060C000



COD.

0480700612

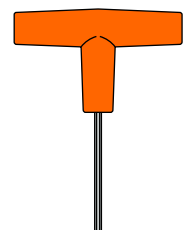

COD.

0480783000



Spiral planing head.  
Light alloy tool body.  
Radiused TC turnover knives for a better finishing.



Cabezal helicoidal para cepillar.  
Cuerpo de aleacion ligera.  
Cuchillas reversibles de metal duro con cantos redondeados para cepillar de acabado.



Porte - outil helicoidal à raboter.  
Corps en alliage léger.  
Plaquettes au carbure réversibles rayonnées pour un meilleur finissage.



Spiral - Hobelmesserkopf.  
Tragkörper aus Leichtmetall.  
HW - Wendeplatte mit Schrägkanten zur Feinbearbeitung.

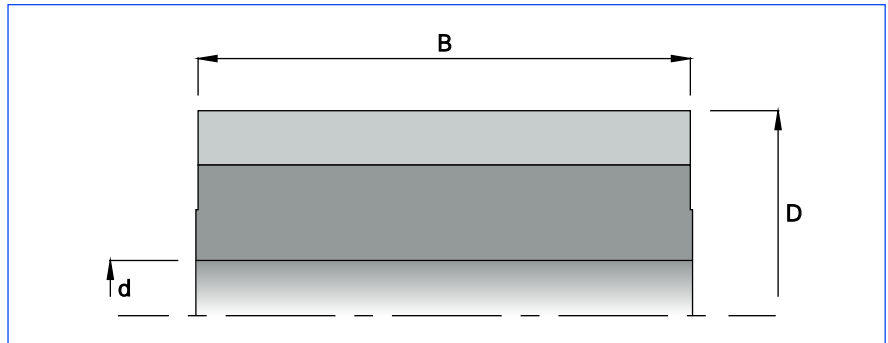

**HW**

**MEC**

D 100 n max 10000  
D 125 n max 8000

- corpo in lega leggera
- completa di coltelli reversibili in HW

D	B	d	Z	COD.
100	120	35	4	0417A01235
100	190	35	4	0417A01935
125	120	40	4	0417A21240
125	130	40	4	0417A21340
125	140	40	4	0417A21440
125	160	40	4	0417A21640
125	180	40	4	0417A21840
125	190	40	4	0417A21940
125	210	40	4	0417A22140
125	230	40	4	0417A22340
125	245	40	4	0417A22440
125	265	50	4	0417A22650



Cottelli reversibili HW HW turnover knives		Cunei di serraggio Clamping wedges	
COD.	B	COD.	B
0417A01235	120	0417C120HW	116
0417A01935	190	0417C190HW	186
0417A21240	120	0417C120HW	116
0417A21340	130	0417C130HW	126
0417A21440	140	0417C140HW	136
0417A21640	160	0417C160HW	156
0417A21840	180	0417C180HW	176
0417A21940	190	0417C190HW	186
0417A22140	210	0417C210HW	206
0417A22340	230	0417C230HW	226
0417A22440	245	0417C245HW	241
0417A22650	265	0417C265HW	261

Ricambi / Spare parts / Rechanges / Repuestos / Ersatzteile



COD.  
048060H000



COD.  
048072B620



COD.  
048078ZL50

Planing head in light - alloy.  
Light alloy tool body.  
Supplied with HW turnover knives.

Cabezal para cepillar de aleacion leggera.  
Cuerpo de aleacion leggera.  
Equipado con cuchillas reversibles de HW.

Porte - outil à raboter en alliage léger.  
Corps en alliage léger.  
Fourni avec couteaux réversibles en HW.

Hobelmesserkopf in Leichtmetall.  
Tragkörper in Leichtmetall.  
Komplett mit HW - Wendemesser.

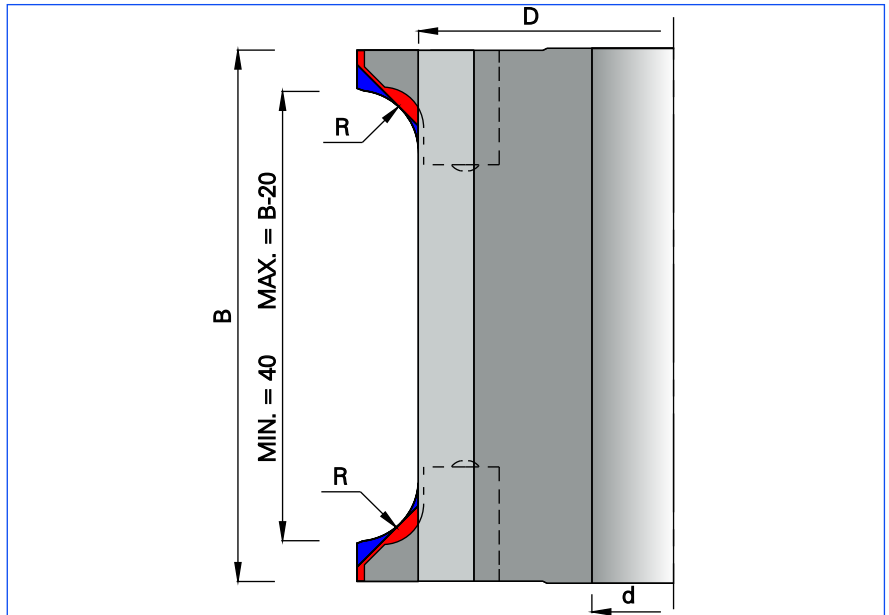

**HW**

**MEC**

D 125 n max 8000

D	B	d	Z	COD.
125	130	40	4	0417R21340
125	180	40	4	0417R21840

- corpo in lega leggera
- completa di coltelli reversibili in HW



Coltelli reversibili HW HW turnover knives		Cunei di serraggio Clamping wedges	
COD.	B	COD.	B
0417R21340	130	0417C130HW	126
0417R21840	180	0417C180HW	176

Ricambi / Spare parts / Rechanges / Repuestos / Ersatzteile

COD. 048060H000	COD. 0480700615	COD. 0480700620	COD. 0401P417R0
COD. 048072B620	COD. 048074B515	COD. 048074C516	COD. 048074A410
COD. 048074P460	COD. 0480783000	COD. 048078ZL50	COD. 048078T200

L.A. Head for planing, rounding and beveling.  
Light alloy tool body.  
Supplied with HW turnover knives.

Cabezal de aleacion leggera para cepillar , redondear y biselar.  
Cuerpo de aleacion leggera.  
Equipado con cuchillas reversibles de HW.

Porte - outil en alliage léger pour raboter , arrondir et chanfreiner.  
Corps en alliage léger.  
Fourni avec couteaux réversibles en HW.

Leichtmetall Messerkopf zum Hobeln, Abrunden und Abfasen.  
Tragkörper in Leichtmetall.  
Komplett mit HW - Wendemesser.



Ricambi / Spare parts / Rechanges / Repuestos / Ersatzteile



COD.

COD.



R=3

K48062E000

K480150000



R=5

K48062ER50

K48015R500



R=8

048062HORH

048015R080

R=10

048062HORH

048015R100

R=12

048062HORH

048015R120

R=15

048062HORH

048015R150



45°

048062HORH

0480154500



COD.

COD.



R=3

K48062E000

K480160000



R=5

K48062ER50

K48016R500



R=8

048062H0LH

048016R080

R=10

048062H0LH

048016R100

R=12

048062H0LH

048016R120

R=15

048062H0LH

048016R150



45°

048062H0LH

0480164500

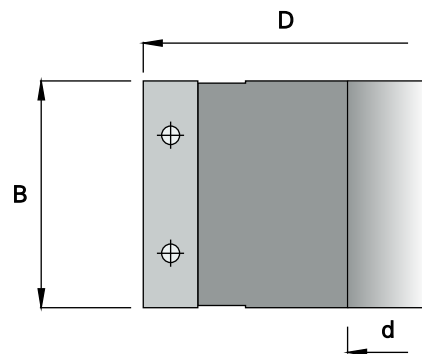

**HW**

**MAN**

n 6200 - 10700



D	B	d	Z	COD.
125	50	35	6	K414120535
125	50	40	6	K414120540
125	60	35	6	K414120635
125	60	40	6	K414120640
125	80	35	6	K414120835
125	80	40	6	K414120840
125	100	35	6	K414121035
125	100	40	6	K414121040

Ricambi / Spare parts / Rechanges / Repuestos / Ersatzteile



COD.

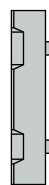

COD.



COD.



COD.

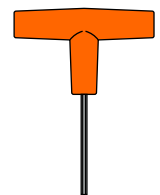

COD.

B = 50	0480050050	0480504600	048060C000	0480700612	0480783000
B = 60	0480050060	0480505600	048060C000	0480700612	0480783000
B = 80	0480050080	0480507600	048060C000	0480700612	0480783000
B = 100	0480050100	0480509600	048060C000	0480700612	0480783000



Jointing cutter head.



Cabezal para cantear.



Porte - outil à dresser.



Fuege - Messerkopf.



**HW**

**MAN**

n 6200 - 10700

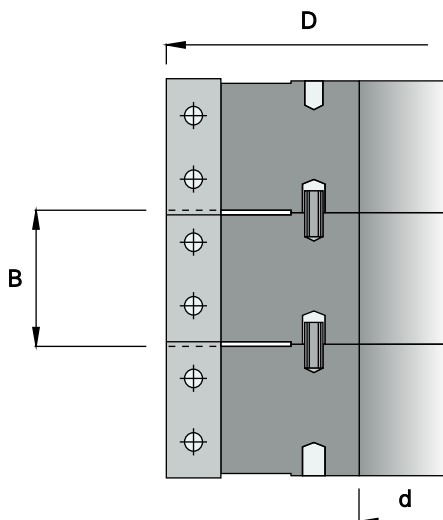

D	B	d	Z	COD.
125	30	35	4	K416123035
125	30	40	4	K416123040
125	50	35	4	K416125035
125	50	40	4	K416125040

### Ricambi / Spare parts / Rechanges / Repuestos / Ersatzteile

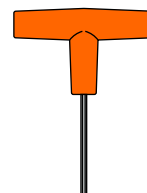
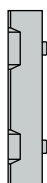
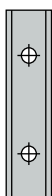

COD.

COD.

COD.

COD.

COD.

B = 30

0480050030

0480502600

048060C000

0480700612

0480783000

B = 50

0480050050

0480504600

048060C000

0480700612

0480783000



Sectional planing cutter heads.



Cabezales sistema modular para cepillar.



Porte - outils composables à raboter.



Hobelmesserkopf Aufbausystem.



**HW**

**MEC**

D 120 n max. 11100  
 D 125 n max. 10700  
 D 140 n max. 9500  
 D 145 n max. 9200  
 D 150 n max. 8900

– abbinabile con art. 384 - 386 - 415 E  
 K 416 - 417 A

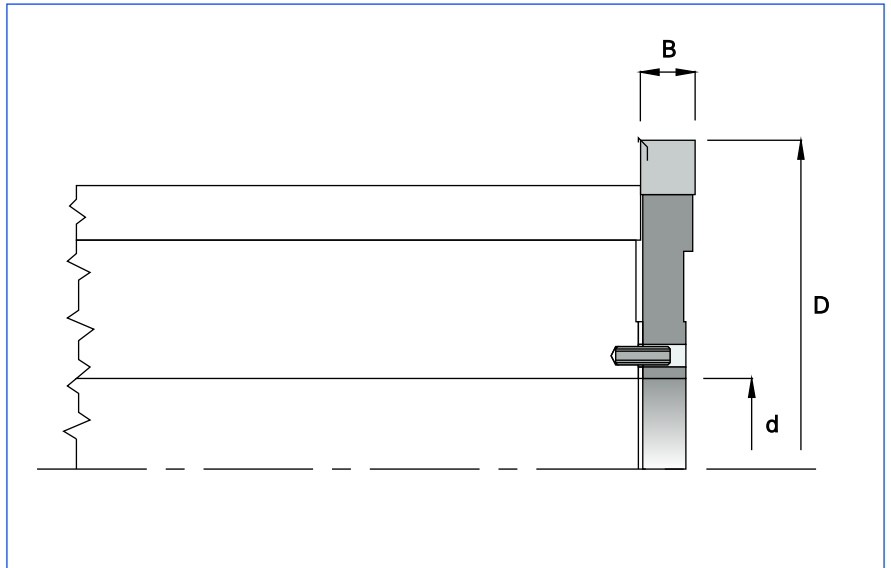
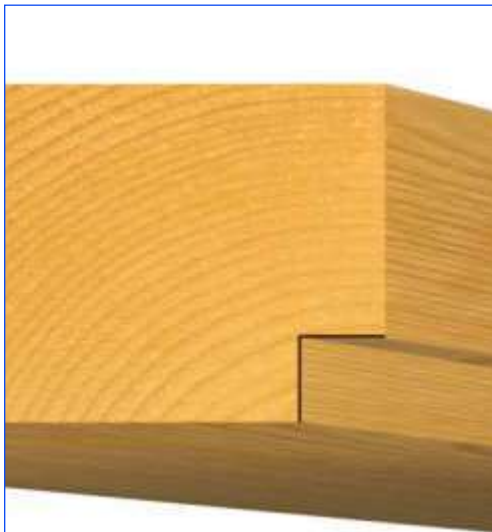

D	B	d	Z	V	COD.
120	12.5	35	2	2	0415R12035
125	12.5	35	2	2	0415R12535
140	12.5	40	2	2	0415R14040
145	12.5	40	2	2	0415R14540
150	12.5	40	2	2	0415R15040

**Ricambi / Spare parts / Rechanges / Repuestos / Ersatzteile**



COD.

0480030014



COD.

0480050012



COD.

0480501000



COD.

048060B000



COD.

0480700512



COD.

048074A510

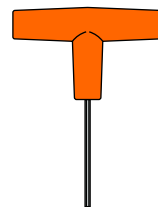

COD.

0480782500

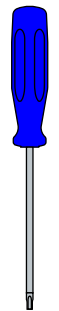

COD.

048078T200



Pre - grooving cutter head.  
 To be used in set with art. 384, 386, 415 - E, K 416, 417 - A.



Cabezal para galce guía.  
 Se combina con art. 384, 386, 415 - E, K 416, 417 - A.



Porte - outil de pre - dégauchissage.  
 A' utiliser avec art. 384, 386, 415 - E, K 416, 417 - A.



Messerkopf für Führungsfalz.  
 Zur Kombination mit art. 384, 386, 415 - E, K 416, 417 - A.

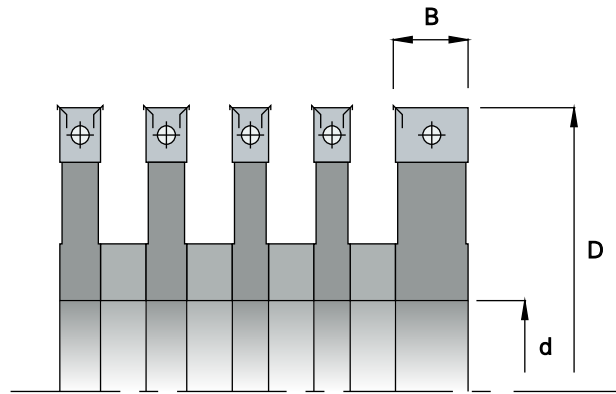

**HW**

**MAN**

D 125 n 6200 - 10700  
D 140 n 5500 - 9500

D	B	d	Z	V	COD.
125	9	40	2	4	K410120940
125	10	40	2	4	K410121040
125	12.5	40	2	4	K410121240
125	17	40	2	2	K410121740
125	20	40	2	2	K410122040
140	12.5	40	2	4	K410141240
140	20	40	2	2	K410142040



Ricambi / Spare parts / Rechanges / Repuestos / Ersatzteile

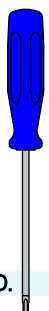
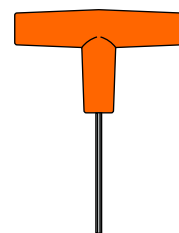

COD.

COD.

COD.

COD.

COD.

COD.

COD.

COD.

B = 9	0480030014	0480050007	0480500700	048060A000	0480700512	048074A507	0480782500	048078T200
B = 10	0480030014	0480050009	0480500700	048060A000	0480700512	048074A507	0480782500	048078T200
B = 12.5	0480030014	0480050012	0480501000	048060B000	0480700512	048074A510	0480782500	048078T200
B = 17	0480030014	0480050017	0480501300	048060C000	0480700612	048074A510	0480783000	048078T200
B = 20	0480030014	0480050020	0480501800	048060C000	0480700612	048074A510	0480783000	048078T200

 Grooving bed cutter heads.

 Cabezales para ranuras guía.

 Porte - outils pour rainures de guidage.

 Nutenbett - Messerköpfe.



# K 419 - B

## Testa per piallare con taglienti alternativamente inclinati

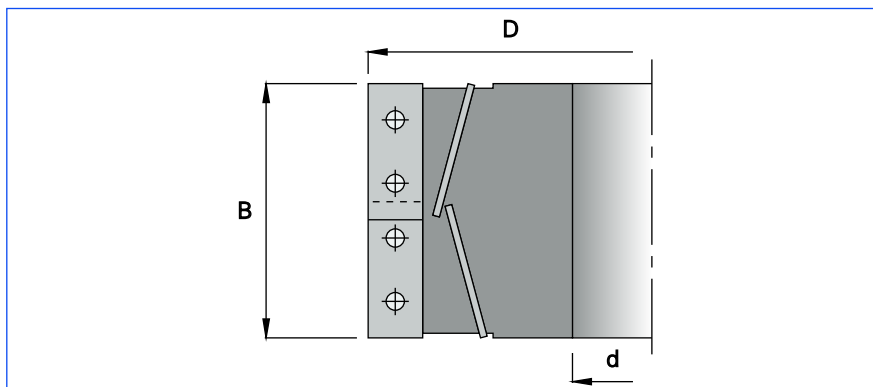

**HW**

**MAN**

D 125 n 6200 - 10700  
D 150 n 5100 - 8900  
D 180 n 4300 - 7400

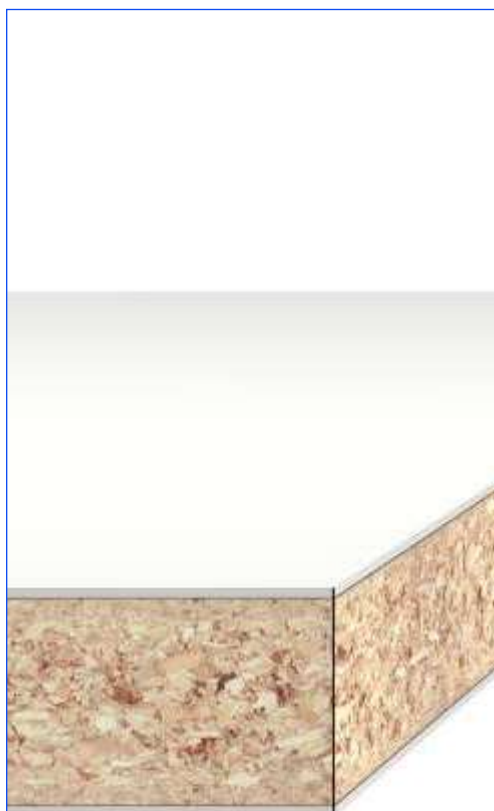

D	B	d	Z	COD.
125	56	30	3+3	K419B25630
125	56	31.75	3+3	K419B25631
125	56	35	3+3	K419B25635
125	56	40	3+3	K419B25640
125	56	50	3+3	K419B25650
150	56	30	3+3	K419B55630
150	56	31.75	3+3	K419B55631
150	56	35	3+3	K419B55635
150	56	40	3+3	K419B55640
150	56	50	3+3	K419B55650
180	56	35	3+3	K419B85635
180	56	40	3+3	K419B85640

### Ricambi / Spare parts / Rechanges / Repuestos / Ersatzteile

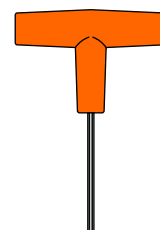
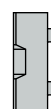

COD.

COD.

COD.

COD.

COD.

0480050030

0480502600

048060C000

0480700612

0480783000



Shear - cut jointing cutter head.



Cabezal para cantear, corte con ángulo axial.



Porte - outil à dresser avec coupes biaisées alternées.



Fuege - Messerkopf mit Achswinkel.

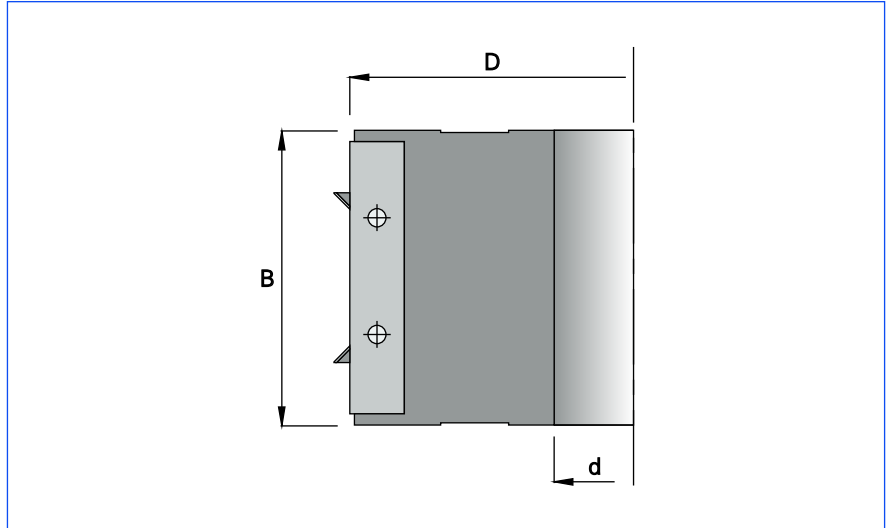

HW

MAN

n 6200 - 10700

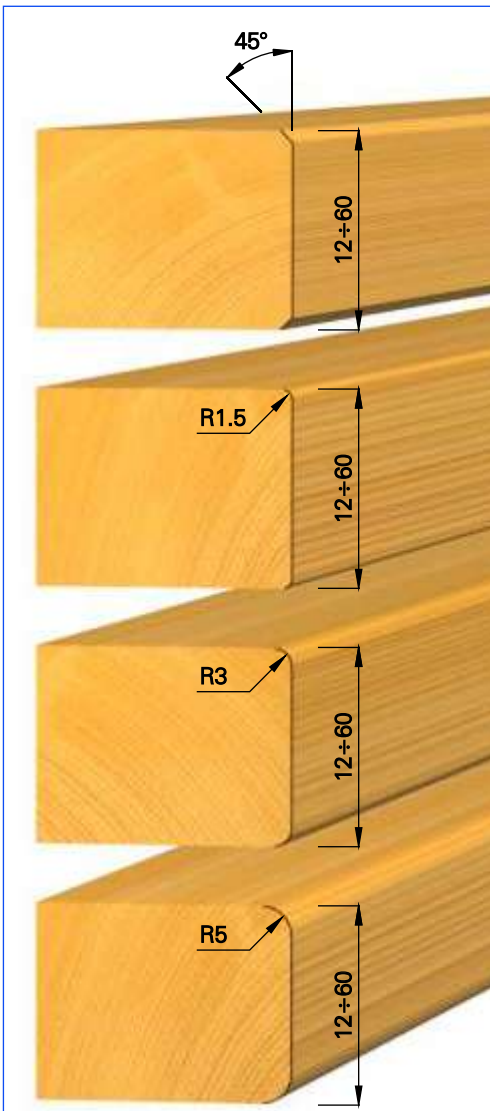

D	B	d	Z	LS	45° COD.	R 1.5 COD.	R 3 COD.	R 5 COD.
125	65	30	2	2+2	K424B13045	K424B130R1	K424B130R3	K424B130R5
125	65	35	2	2+2	K424B13545	K424B135R1	K424B135R3	K424B135R5
125	65	40	2	2+2	K424B14045	K424B140R1	K424B140R3	K424B140R5
125	65	50	2	2+2	K424B15045	K424B150R1	K424B150R3	K424B150R5

Ricambi / Spare parts / Rechanges / Repuestos / Ersatzteile

COD. COD. COD. COD. COD. COD. COD.  
 0480050060 0480505600 048060C000 0480700612 0480700620 048074B515 048074C516

COD. COD. COD. COD.  
 K480110000 K480130000 K480150000 K48015R500

COD. COD.  
 K48062E000 (45°-R1.5-R3) K48062ER50 (R5)

COD. COD. COD. COD. COD. COD.  
 K480120000 K480140000 K480160000 K48016R500 0480783000 048078T200

Jointing cutter head with edge - breakers.

Cabezal para cantear con mata - cantos.

Porte - outil à dresser avec brise - aretes.

Fugee - Messerkopf mit Kantenbrechern.

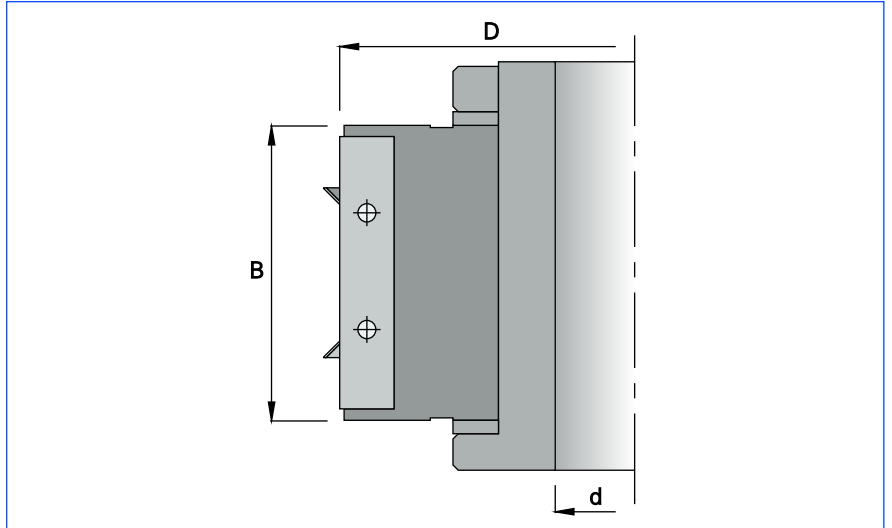

**HW**

**MAN**

n 5900 - 10200

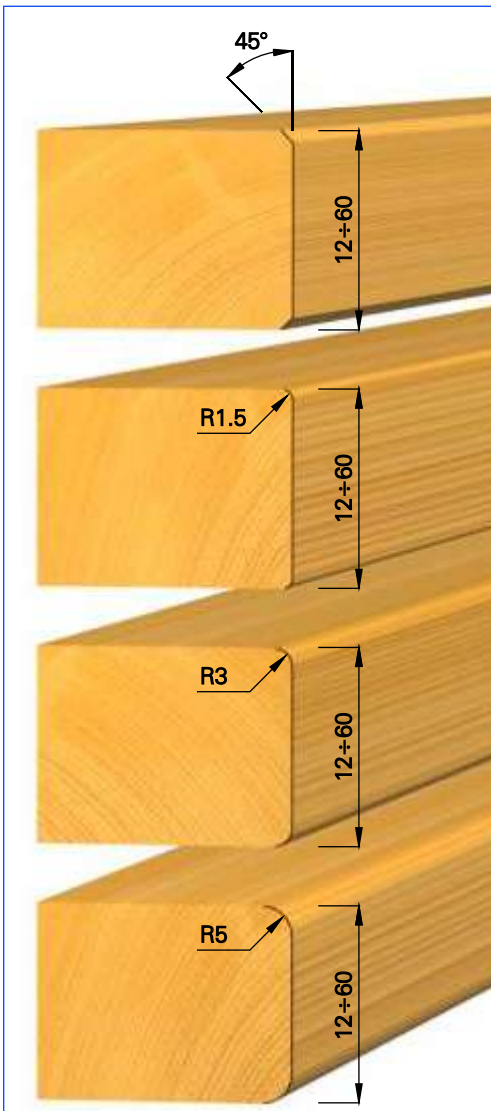

D	B	d	Z	LS	45° COD.	R 1.5 COD.	R 3 COD.	R 5 COD.
130	65	30	4	2+2	K424B23045	K424B230R1	K424B230R3	K424B230R5
130	65	31.75	4	2+2	K424B23145	K424B231R1	K424B231R3	K424B231R5
130	65	35	4	2+2	K424B23545	K424B235R1	K424B235R3	K424B235R5
130	65	40	4	2+2	K424B24045	K424B240R1	K424B240R3	K424B240R5
130	65	50	4	2+2	K424B25045	K424B250R1	K424B250R3	K424B250R5

### Ricambi / Spare parts / Rechanges / Repuestos / Ersatzteile

COD.    COD.    COD.    COD.    COD.    COD.    COD.  
 0480050060    0480505600    048060C000    0480700612    0480700620    048074B515    048074C516

COD.    COD.    COD.    COD.  
 K480110000    K480130000    K480150000    K48015R500

COD.    COD.  
 K48062E000 (45°-R1.5-R3)    K48062ER50 (R5)

COD.    COD.    COD.    COD.    COD.    COD.  
 K480120000    K480140000    K480160000    K48016R500    0480783000    048078T200

Jointing cutter head with edge - breakers.

Cabezal para cantear con mata - cantos.

Porte - outil à dresser avec brise - aretes.

Füge - Messerkopf mit Kantenbrechern.

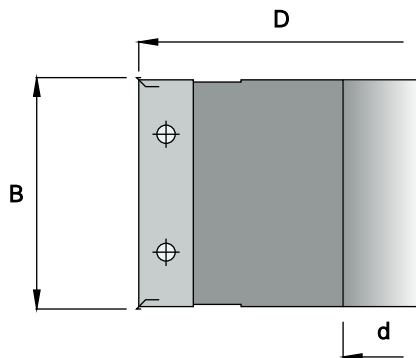

**HW**

**MAN**

D 100 n 7700 - 13300  
D 125 n 6200 - 10700

D	B	d	Z	V	COD.
100	31	30	2	4	K418203130
100	31	31.75	2	4	K418203131
100	31	35	2	4	K418203135
125	31	30	2	4	K418223130
125	31	31.75	2	4	K418223131
125	31	35	2	4	K418223135
125	31	40	2	4	K418223140
125	31	50	2	4	K418223150
100	51	30	2	4	K418205130
100	51	31.75	2	4	K418205131
100	51	35	2	4	K418205135
125	51	30	2	4	K418225130
125	51	31.75	2	4	K418225131
125	51	35	2	4	K418225135
125	51	40	2	4	K418225140
125	51	50	2	4	K418225150



### Ricambi / Spare parts / Rechanges / Repuestos / Ersatzteile

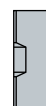

COD.

COD.

COD.

COD.

B = 31    0480030014    0480050030    0480502600    048060C000

B = 51    0480030014    0480050050    0480504600    048060C000

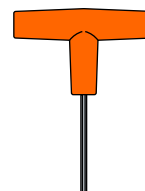

COD.

COD.

COD.

COD.

B = 31    0480700612    048074A510    0480783000    048078T200

B = 51    0480700612    048074A510    0480783000    048078T200



Rebating cutter head.



Cabezal para galgear.



Porte - outil à feuillure.



Falzmesserkopf.

# K418 - 4

## Testa per battute con taglienti diritti

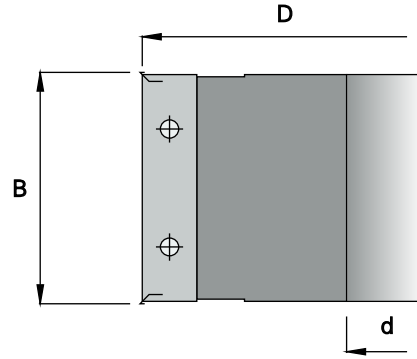

**HW**

**MAN**

D 125 n 6200 - 10700  
 D 140 n 5500 - 9500  
 D 180 n 4300 - 7400



D	B	d	Z	V	COD.
125	31	30	4	4	K418423130
125	31	31.75	4	4	K418423131
125	31	35	4	4	K418423135
125	31	40	4	4	K418423140
125	31	50	4	4	K418423150
140	31	30	4	4	K418443130
140	31	31.75	4	4	K418443131
140	31	35	4	4	K418443135
140	31	40	4	4	K418443140
140	31	50	4	4	K418443150
180	31	30	4	4	K418483130
180	31	31.75	4	4	K418483131
180	31	35	4	4	K418483135
180	31	40	4	4	K418483140
180	31	50	4	4	K418483150
125	51	30	4	4	K418425130
125	51	31.75	4	4	K418425131
125	51	35	4	4	K418425135
125	51	40	4	4	K418425140
125	51	50	4	4	K418425150
140	51	30	4	4	K418445130
140	51	31.75	4	4	K418445131
140	51	35	4	4	K418445135
140	51	40	4	4	K418445140
140	51	50	4	4	K418445150
180	51	30	4	4	K418485130
180	51	31.75	4	4	K418485131
180	51	35	4	4	K418485135
180	51	40	4	4	K418485140
180	51	50	4	4	K418485150
125	61	30	4	4	K418426130
125	61	31.75	4	4	K418426131
125	61	35	4	4	K418426135
125	61	40	4	4	K418426140
125	61	50	4	4	K418426150



Ricambi / Spare parts / Rechanges / Repuestos / Ersatzteile

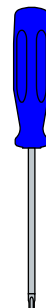
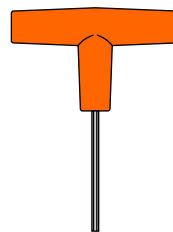
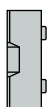

	COD.	COD.	COD.	COD.	COD.	COD.	COD.	COD.
B = 31	0480030014	0480050030	0480502600	048060C000	0480700612	048074A510	0480783000	048078T200
B = 51	0480030014	0480050050	0480504600	048060C000	0480700612	048074A510	0480783000	048078T200
B = 61	0480030014	0480050060	0480505600	048060C000	0480700612	048074A510	0480783000	048078T200

 Rebating cutter head.

 Cabezal para galcear.

 Porte - outil à feuillure.

 Falzmesserkopf.

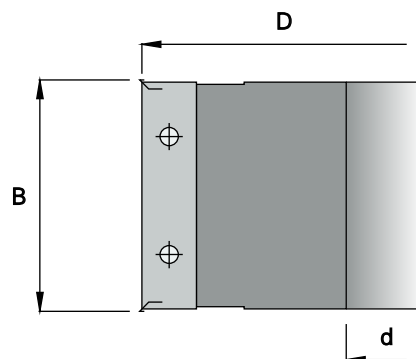

**HW**

**MAN**

n 6200 - 10700

D	B	d	Z	V	COD.
125	51	30	4	4	K419A25130
125	51	31.75	4	4	K419A25131
125	51	35	4	4	K419A25135
125	51	40	4	4	K419A25140
125	51	50	4	4	K419A25150



### Ricambi / Spare parts / Rechanges / Repuestos / Ersatzteile



COD.

COD.

COD.

COD.

0480030014

0480050050

0480504600

048060C000

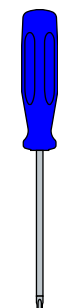
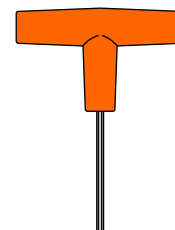

COD.

COD.

COD.

COD.

0480700612

048074A510

0480783000

048078T200



Shear - cut rebating cutter head.



Cabezal para galcear, corte con ángulo axial.



Porte - outil à feuillure avec coupe biais.



Falzmesserkopf mit Achswinkel.

# K 420

## Testa ad inclinazione variabile regolabile da 0° a 60° di grado in grado

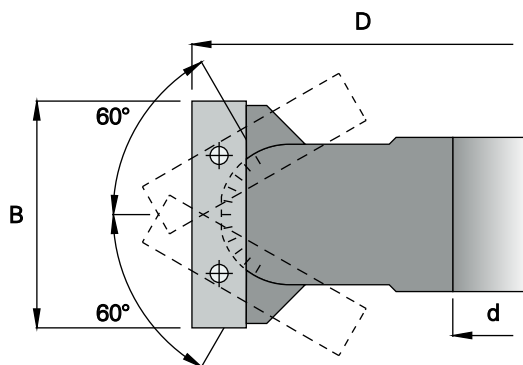

**HW**

**MAN**

D 150 n 5100 - 8900  
D 160 n 4800 - 8300

D	B	d	Z	COD.
150	50	30	2	K420000030
150	50	31.75	2	K420000031
150	50	35	2	K420000035
150	50	40	2	K420000040
160	50	50	2	K420000050



### Ricambi / Spare parts / Rechanges / Repuestos / Ersatzteile



COD.

0480050050



COD.

048050Z000



COD.

0480700615



COD.

048070Z126

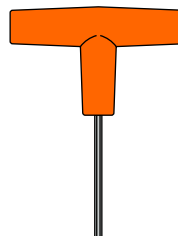

COD.

0480783000



COD.

048078Z060



Pivoting cutter head.  
Adjustable between 0° and 60° in increments of 1°.



Porte - outil à chanfreiner.  
Inclinable de 0° a 60° degré par degré.



Cabezal para biselar.  
Ajustable de 0° a 60°, de 1° en 1°.



Fasemesserkopf.  
Schwenkbereich 0° - 60°, von 1° zu 1° verstellbar.



# Teste portacoltelli con placchette profilate



Cutter heads with profiled plates.



Cabezales con cuchillas perfiladas.



Porte - outils avec plaquettes profilées.



Messerköpfe mit Profilplatten.

ART. 424 - C



5.2

ART. K 424 - E



5.4

ART. 425



5.5

ART. 400



5.103

ART. K 428 - A



5.11

ART. 428 - B / C / D



5.13

ART. K 428 - E



5.16

ART. K 428 - F



5.17

ART. K 428 - G



5.18

ART. K 428 - R



5.20

ART. K 428 - T



5.21

ART. 428 - Z



5.22

ART. K 426 - 1



5.24

ART. K 426 - 2



5.26

ART. K 426 - 5/6P



5.28

ART. K 426 - P/W



5.32

ART. K 427 - 1



5.36

ART. K 427 - 2



5.38

ART. K 427 - 3



5.40

ART. K 427 - 4



5.41

ART. K 427 - 5



5.42

ART. K 427 - 6



5.43

ART. K 427 - 7



5.44

ART. K 427 - 9



5.45





 Cutter heads with profiled plates.

 Cabezales con cuchillas perfiladas.

 Porte - outils avec plaquettes profilées.

 Messerköpfe mit Profilplatten.





**HW**

**MEC**

n max 8600

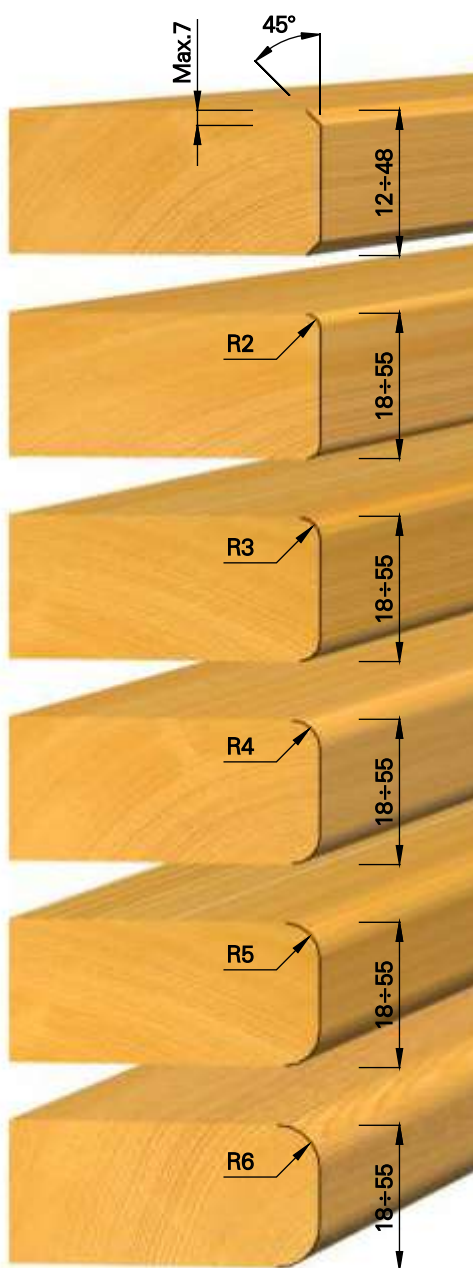
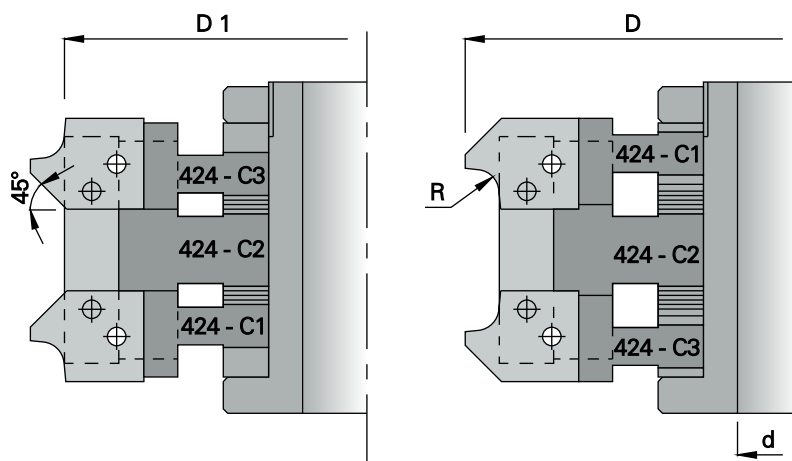

D	D1	d	R	Z	COD.
155	140	30	2	2	0424C30R02
155	140	31.75	2	2	0424C31R02
155	140	35	2	2	0424C35R02
155	140	40	2	2	0424C40R02
155	140	50*	2	2	0424C50R02
155	140	30	3	2	0424C30R03
155	140	31.75	3	2	0424C31R03
155	140	35	3	2	0424C35R03
155	140	40	3	2	0424C40R03
155	140	50*	3	2	0424C50R03
155	140	30	4	2	0424C30R04
155	140	31.75	4	2	0424C31R04
155	140	35	4	2	0424C35R04
155	140	40	4	2	0424C40R04
155	140	50*	4	2	0424C50R04
155	140	30	5	2	0424C30R05
155	140	31.75	5	2	0424C31R05
155	140	35	5	2	0424C35R05
155	140	40	5	2	0424C40R05
155	140	50*	5	2	0424C50R05
155	140	30	6	2	0424C30R06
155	140	31.75	6	2	0424C31R06
155	140	35	6	2	0424C35R06
155	140	40	6	2	0424C40R06
155	140	50*	6	2	0424C50R06

\* Senza mozzo / Without sleeve / Sans manchon / Sin casquillo / Ohne Spannbuchse.



Ricambi / Spare parts / Rechanges / Repuestos / Ersatzteile

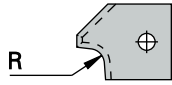

R	COD.
2	048024R2A0
3	048024R3A0
4	048024R4A0
5	048024R5A0
6	048024R6A0

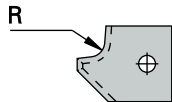

R	COD.
2	048024R2B0
3	048024R3B0
4	048024R4B0
5	048024R5B0
6	048024R6B0

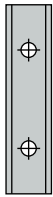

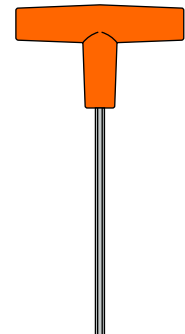
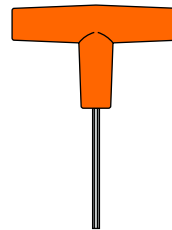

COD.	COD.	COD.	COD.	COD.
0480050050	0480504600	0480521810	048060C000	0480700612



COD.	COD.	COD.	COD.
0480700820	048073B000	0480783000	048078L400

 Cutter head set for jointing, rounding and beveling.

 Juego de cabezales para cantear, biselar y redondear.

 Jeu de porte - outils pour dresser, arrondir et chanfreiner.

 Messerkopfsatz zum Fügen, Abrunden und Fasen.

# K 424 - E

## Gruppo di teste registrabili per incastri e battute con levaspigoli



**HW**

**MAN**

n 4200 - 7200

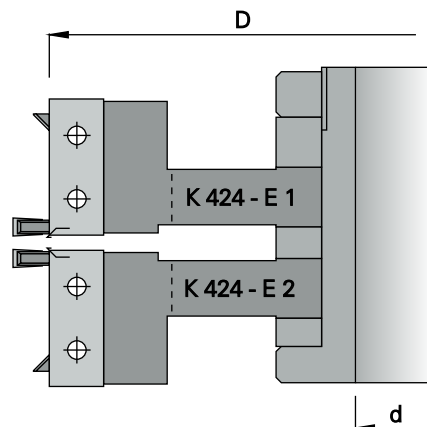

D	B	d	Z	V	LS	DG	45° COD.	R 1.5 COD.	R 3 COD.	R 5 COD.
170	31-59	30	2+2	2+2	2+2	2+2	K424E03045	K424E030R1	K424E030R3	K424E030R5
170	31-59	31.75	2+2	2+2	2+2	2+2	K424E03145	K424E031R1	K424E031R3	K424E031R5
170	31-59	35	2+2	2+2	2+2	2+2	K424E03545	K424E035R1	K424E035R3	K424E035R5
170	31-59	40	2+2	2+2	2+2	2+2	K424E04045	K424E040R1	K424E040R3	K424E040R5
170	31-59	50*	2+2	2+2	2+2	2+2	K424E05045	K424E050R1	K424E050R3	K424E050R5

\* Senza mozzo / Without sleeve / Sans manchon / Sin casquillo / Ohne Spannbuchse.

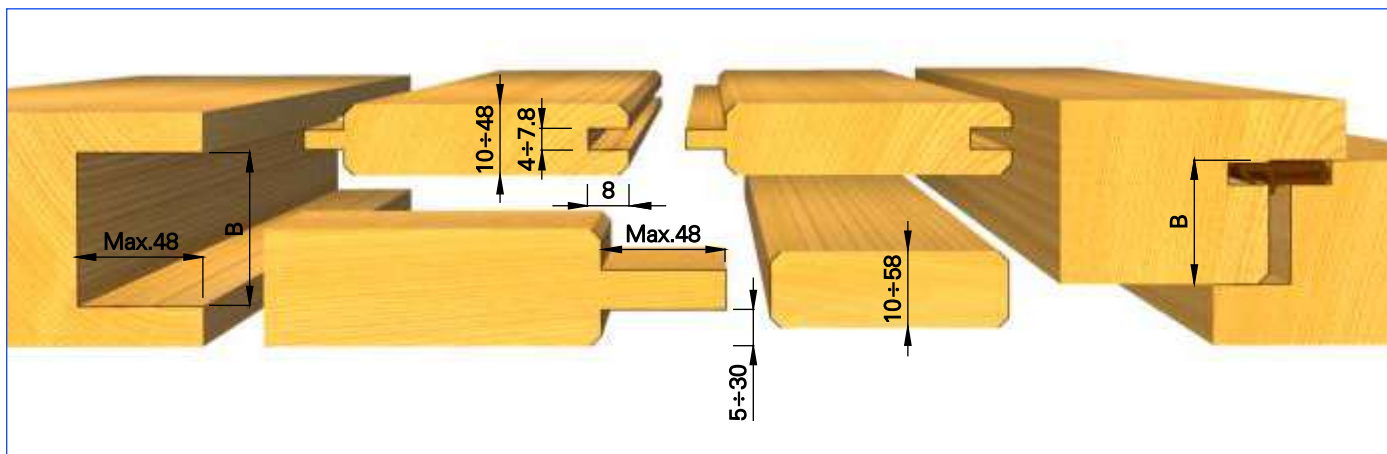

**Ricambi / Spare parts / Rechanges / Repuestos / Ersatzteile**

COD.	COD.	COD.	COD.	COD.	COD.	COD.	COD.	COD.	COD.
0480030014	0480050030	0480502600	048060C000	0480700612	0480700620	048074A510	048074B515	048074C515	048074C516
45°	45°	R 1.5	R 1.5	R 3	R 3	R 5	R 5	(45°-R1.5-R3)	(R5)
COD.	COD.	COD.	COD.	COD.	COD.	COD.	COD.	COD.	COD.
K480110000	K480120000	K480130000	K480140000	K480150000	K480160000	K48015R500	K48016R500	K48062E000	K48062ER50
COD.	COD.	COD.							
K48017E000	0480783000	048078T200							

Grooving and rebating adjustable set with edge - breakers.

Juego de cabezales extensible con chaflanadores para ranurar y galcear.

Jeu de porte - outils extensible avec brise - arêtes pour rainures et feuillures.

Verstellbar Messerkopfsatz mit Kantenbrechern zum Nuten und Falzen.



LH



RH

**HW**

**MEC**

n max 7000

D (LH)	D (RH)	d	Z	COD. LH + RH
134	139	35	3	0425050035
134	139	40	3	0425050040

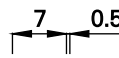
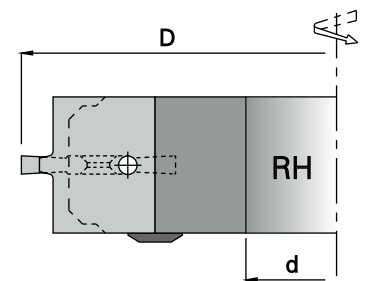
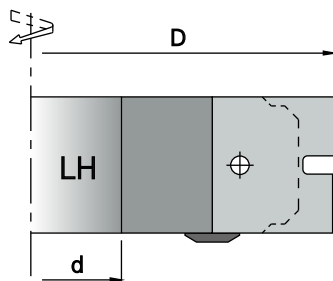

**Ricambi / Spare parts / Rechanges / Repuestos / Ersatzteile**

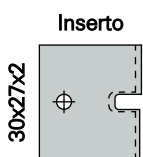

30x27x2

Inserto

COD.  
04802551LH

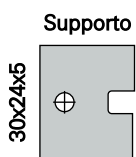

30x24x5

Supporto

COD.  
04802552LH

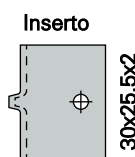

30x25.5x2

Inserto

COD.  
04802551RH

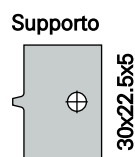

30x22.5x5

Supporto

COD.  
04802552RH

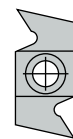

COD.  
048019B000

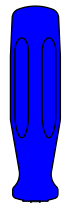

COD.  
048078T200

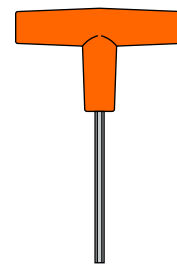

COD.  
048078L500

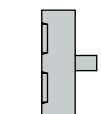

COD.  
04805128F0



COD.  
048074C515



COD.  
048073B000



COD.  
0480701020

Tongue and groove cutter head set.

Juego de cabezales para machihembrar.

Jeu de porte - outils pour rainure et languette.

Messerkopfsatz für Nut - und Federprofil.



LH



RH

**HW**

**MEC**

n max 7000

D (LH)	D (RH)	d	Z	COD. LH + RH
144	139	35	3	0425060035
144	139	40	3	0425060040

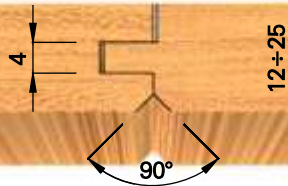
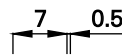
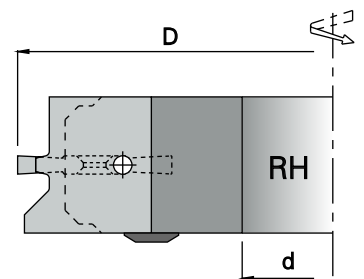
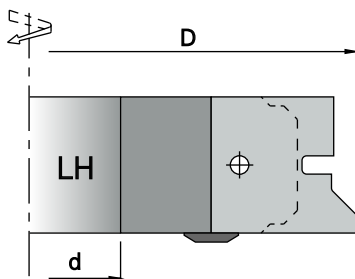

**Ricambi / Spare parts / Rechanges / Repuestos / Ersatzteile**

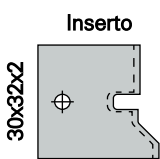

Inserto

30x32x2

COD.  
04802561LH

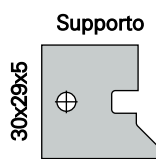

Supporto

30x29x5

COD.  
04802562LH

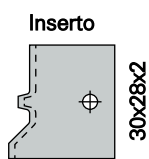

Inserto

30x28x2

COD.  
04802561RH

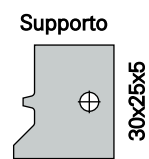

Supporto

30x25x5

COD.  
04802562RH



COD.  
048019B000

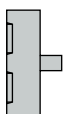

COD.  
04805128F0



COD.  
048074C515



COD.  
048073B000



COD.  
0480701020

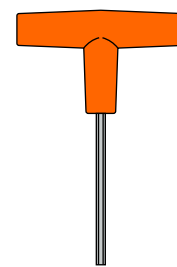

COD.  
048078L500

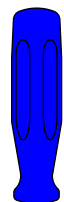

COD.  
048078T200



Tongue and groove cutter head set.



Juego de cabezales para machihembrar.



Jeu de porte - outils pour rainure et languette.



Messerkopfsatz für Nut - und Federprofil.



LH



RH

**HW**

**MEC**

n max 7000

D (LH)	D (RH)	d	Z	COD. LH + RH
144	139	35	3	0425070035
144	139	40	3	0425070040

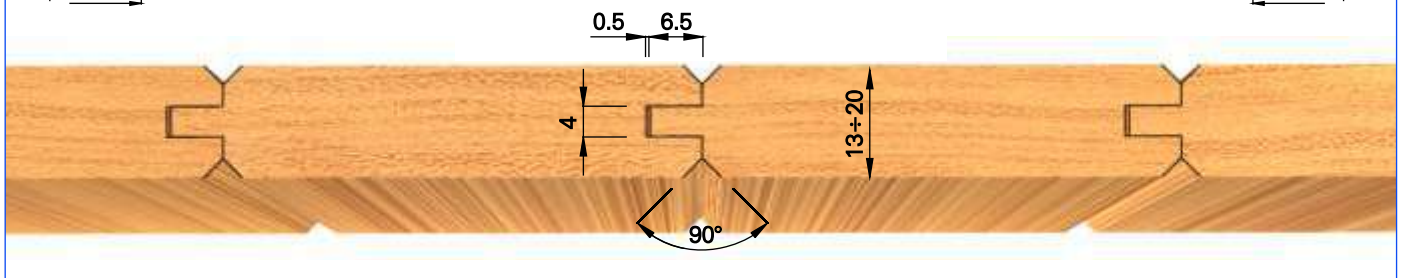
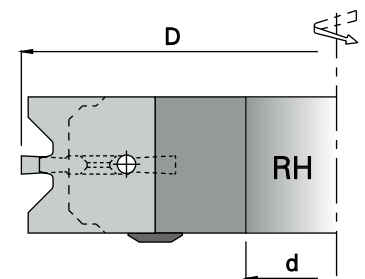
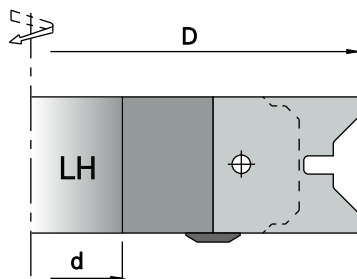

Ricambi / Spare parts / Rechanges / Repuestos / Ersatzteile

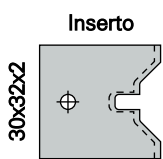

Inserto

30x32x2

COD.

04802571LH

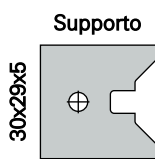

Supporto

30x29x5

COD.

04802572LH

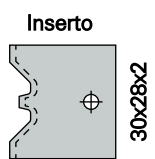

Inserto

30x28x2

COD.

04802571RH

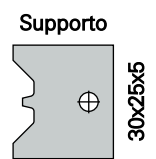

Supporto

30x25x5

COD.

04802572RH

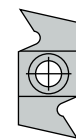

COD.

048019B000

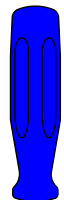

COD.

048078T200

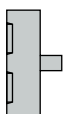

COD.

04805128F0



COD.

048074C515



COD.

048073B000



COD.

0480701020

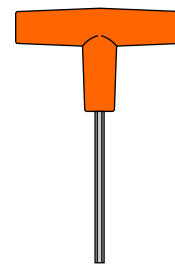

COD.

048078L500

Tongue and groove cutter head set.

Juego de cabezales para machihembrar.

Jeu de porte - outils pour rainure et languette.

Messerkopfsatz für Nut - und Federprofil.





LH



RH

**HW**

**MEC**

n max 7000

D (LH)	D (RH)	d	Z	COD. LH + RH
144	139	35	3	0425080035
144	139	40	3	0425080040

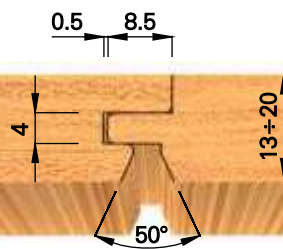
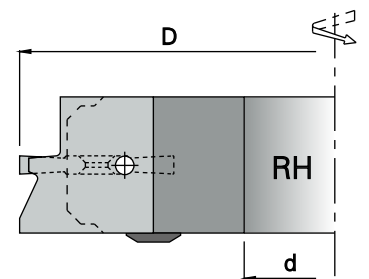
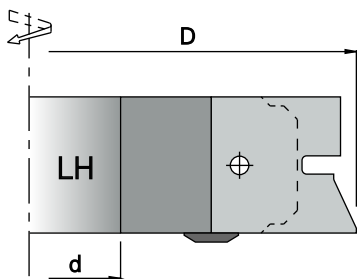

**Ricambi / Spare parts / Rechanges / Repuestos / Ersatzteile**

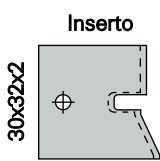

30x32x2  
COD. 04802581LH

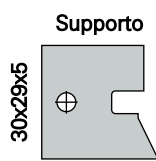

30x29x5  
COD. 04802582LH



30x29.5x2  
COD. 04802581RH

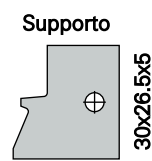

30x26.5x5  
COD. 04802582RH



COD. 048019B000

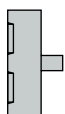

COD. 04805128F0



COD. 048074C515



COD. 048073B000



COD. 0480701020

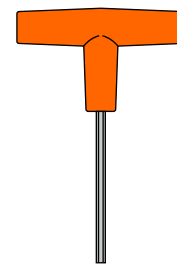

COD. 048078L500

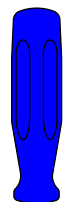

COD. 048078T200



Tongue and groove cutter head set.



Juego de cabezales para machihembrar.



Jeu de porte - outils pour rainure et languette.



Messerkopfsatz für Nut - und Federprofil.



**HW**

**MEC**

n max 7000

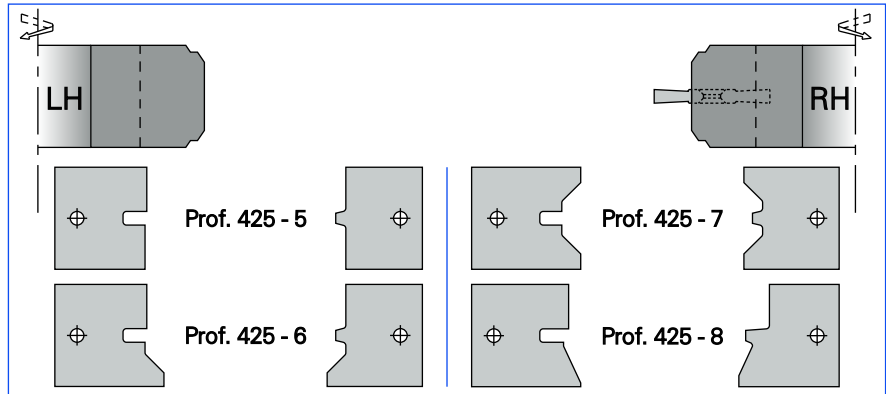

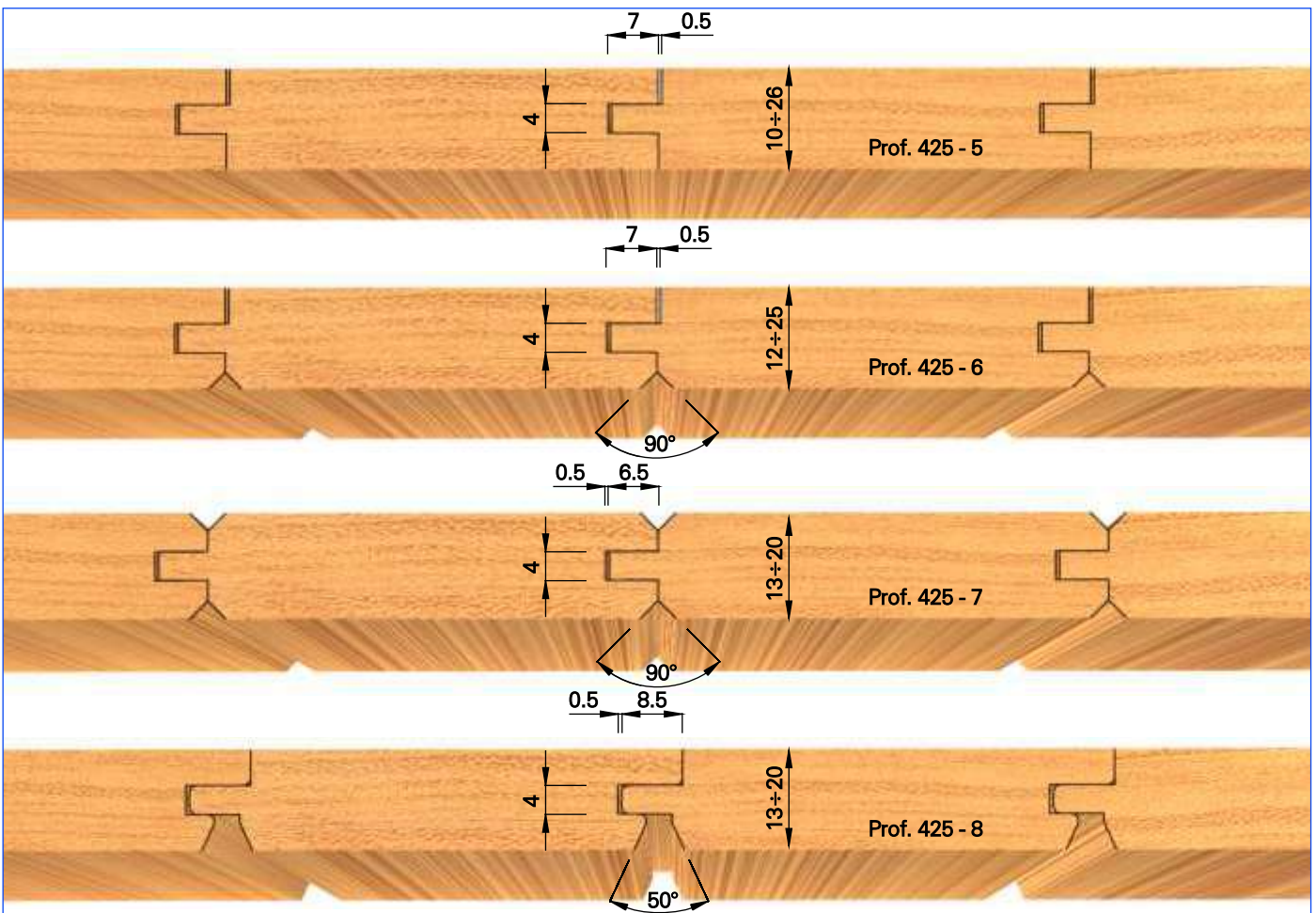

Il set completo per 4 profili : 425 - 5 / 425 - 6 / 425 - 7 / 425 - 8  
 é composto da :  
 - 2 teste Art 400 ( 1 x LH + 1 x RH ) ;  
 - 8 terne di piastrine Art 401 - P ( 4 x LH + 4 x RH ) ;  
 - 8 terne di placchette Art 402 - P ( 4 x LH + 4 x RH ) ;  
 - 1 cassetta in legno.

d	Z	COD. LH + RH
35	3	0425S00035
40	3	0425S00040



 **Tongue and groove cutter head set.**  
 The set complete for 4 profiles Art 425 - 5 / 425 - 6 / 425 - 7 / 425 - 8 includes :  
 - 2 cutter heads Art 400 ( 1 x LH + 1 x RH ) ;  
 - 8 terns of plates Art 401 - P ( 4 x LH + 4 x RH ) ;  
 - 8 terns of plates Art 402 - P ( 4 x LH + 4 x RH ) ;  
 - 1 wooden case.

 **Juego de cabezales para machihembrar.**  
 El juego completo para 4 perfiles Art 425 - 5 / 425 - 6 / 425 - 7 / 425 - 8 comprende :  
 - 2 cabezales Art 400 ( 1 x LH + 1 x RH ) ;  
 - 8 ternos de plaquetas Art 401 - P ( 4 x LH + 4 x RH ) ;  
 - 8 ternos de cuchillas Art 402 - P ( 4 x LH + 4 x RH ) ;  
 - 1 estuche de madera.

 **Jeu de porte - outils pour rainure et languette.**  
 Le jeu complet pour 4 profils Art 425 - 5 / 425 - 6 / 425 - 7 / 425 - 8 comprend :  
 - 2 porte - outils Art 400 ( 1 x LH + 1 x RH ) ;  
 - 8 jeux de 3 plaquettes Art 401 - P ( 4 x LH + 4 x RH ) ;  
 - 8 jeux de 3 plaquettes Art 402 - P ( 4 x LH + 4 x RH ) ;  
 - 1 boite en bois.

 **Messerkopfsatz für Nut - und Federprofilen.**  
 Der Satz komplett für 4 Profilen Art 425 - 5 / 425 - 6 / 425 - 7 / 425 - 8 besteht aus:  
 - 2 Messerköpfen Art 400 ( 1 x LH + 1 x RH ) ;  
 - 8 Platten - Dreiheiten Art 401 - P ( 4 x LH + 4 x RH ) ;  
 - 8 Platten - Dreiheiten Art 402 - P ( 4 x LH + 4 x RH ) ;  
 - 1 Holz - Etui.



LH

RH

HW

MAN

n 4800 - 8300

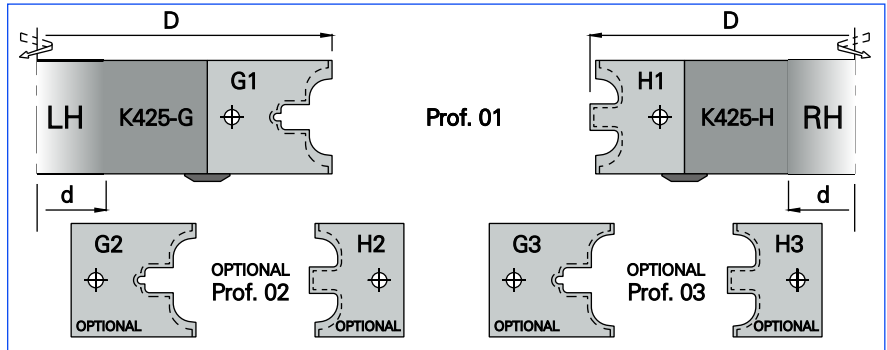

D (LH)	D (RH)	d	Z	COD. LH + RH
156	140	35	3	K425090035
156	140	40	3	K425090040

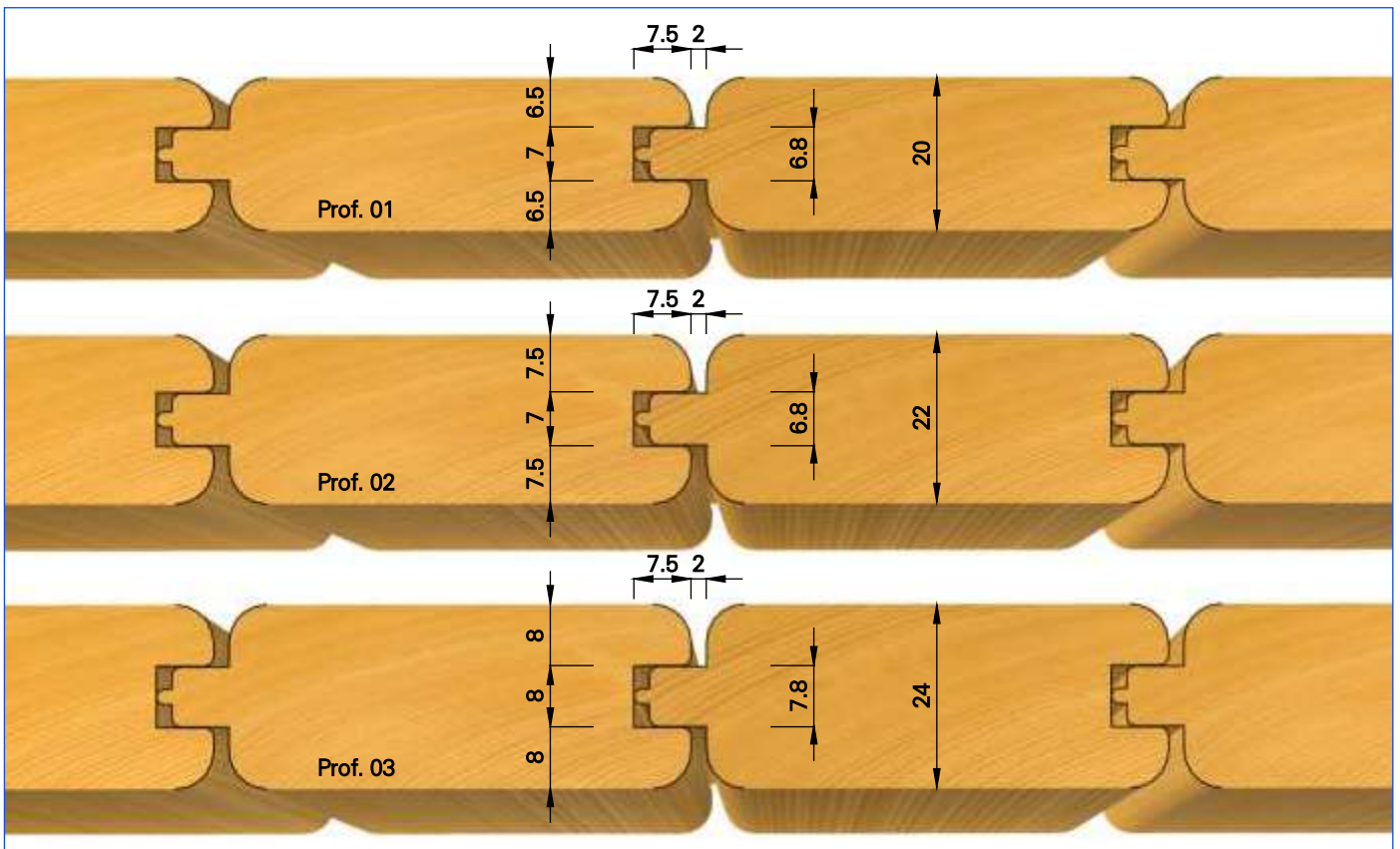

### Ricambi / Spare parts / Rechanges / Repuestos / Ersatzteile

 Prof. 01 30x33x2 COD. K48025G100	 Prof. 02 30x33x2 COD. K48025G200	 Prof. 03 30x33x2 COD. K48025G300	 Prof. 01 30x25x2 COD. K48025H100	 Prof. 02 30x25x2 COD. K48025H200	 Prof. 03 30x25x2 COD. K48025H300
 COD. 0480522825	 COD. 0480700820	 COD. 048073B000	 COD. 048078L400		

Tongue and groove cutter head set.

Juego de cabezales para machihembrar.

Jeu de porte - outils pour rainure et languette.

Messerkopfsatz für Nut - und Federprofil.

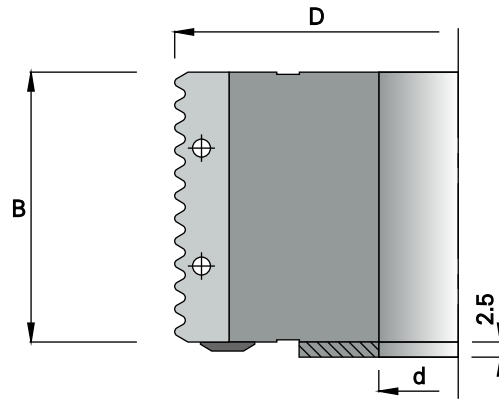

**HW**

**MAN**

n 6200 - 10700

D	B	d	Z	COD.
125	60	30	2	K428A00030
125	60	31.75	2	K428A00031
125	60	35	2	K428A00035
125	60	40	2	K428A00040
125	60	50	2	K428A00050

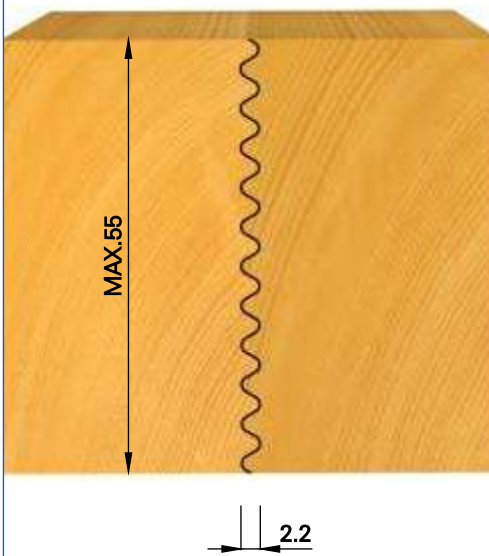

### Ricambi / Spare parts / Rechanges / Repuestos / Ersatzteile

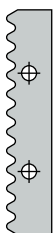

60x12x1.5

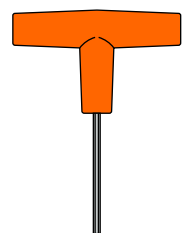
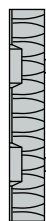

COD.  
K48028A000

COD.  
0480505628

COD.  
048060C000

COD.  
0480700612

COD.  
048073B000

COD.  
0480783000

 Glue jointing cutter head.

 Cabezal para ensamble.

 Porte - outil pour abouter.

 Verleim - Messerkopf.

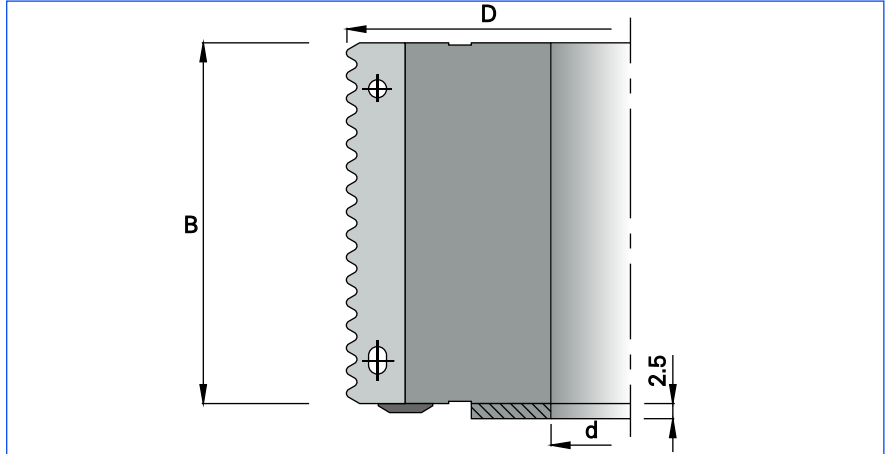

**HW**



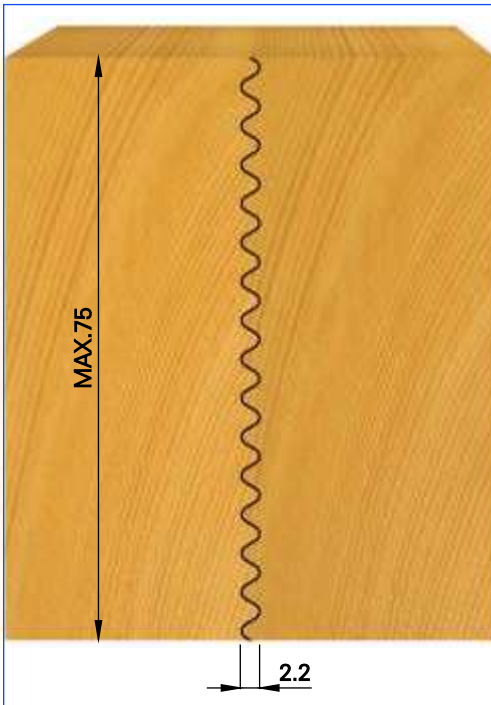

**MAN**

n 6200 - 10700



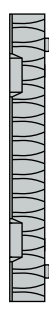

D	B	d	Z	COD.
125	80	30	2	K428A08030
125	80	31.75	2	K428A08031
125	80	35	2	K428A08035
125	80	40	2	K428A08040
125	80	50	2	K428A08050

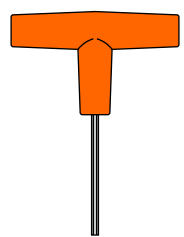
Ricambi / Spare parts / Rechanges / Repuestos / Ersatzteile

					
80x13x2.2					
COD. K48028A080	COD. 0480507628	COD. 048060C000	COD. 0480700612	COD. 048073B000	COD. 0480783000

 Glue jointing cutter head.

 Cabezal para ensamble.

 Porte - outil pour abouter.

 Verleim - Messerkopf.

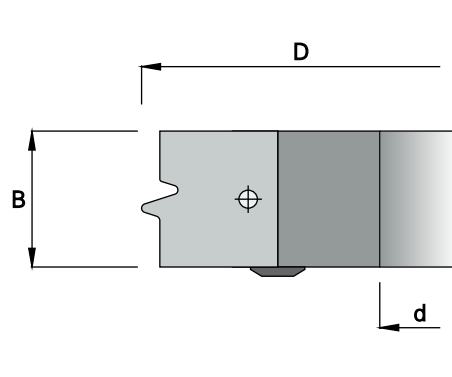

**HW**

**MEC**

n max 7000

D	B	d	Z	COD.
140	30	30	3	0428B00030
140	30	35	3	0428B00035
140	30	40	3	0428B00040
140	30	50	3	0428B00050

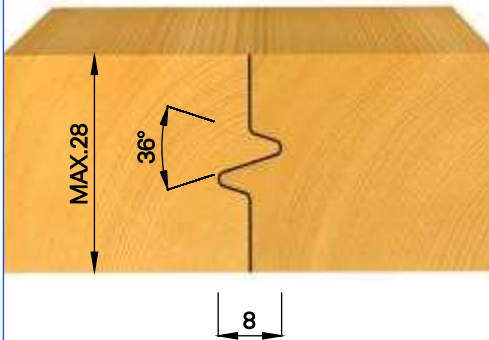

**Ricambi / Spare parts / Rechanges / Repuestos / Ersatzteile**

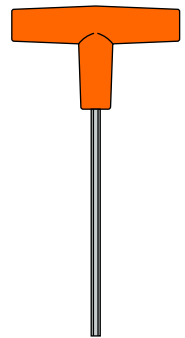

Inserto

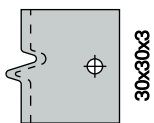

30x30x3

Supporto

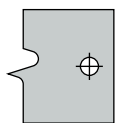

30x26.5x5

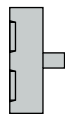

COD.  
048028B003

COD.  
048028B001

COD.  
04805128F0

COD.  
0480701020

COD.  
048073B000

COD.  
048078L500

Glue jointing cutter head.

Cabezal para ensamble.

Porte - outil pour abouter.

Verleim - Messerkopf.

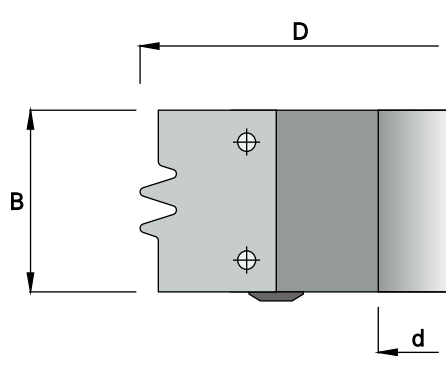

**HW**

**MEC**

n max 7000

D	B	d	Z	COD.
140	40	30	3	0428C00030
140	40	35	3	0428C00035
140	40	40	3	0428C00040
140	40	50	3	0428C00050

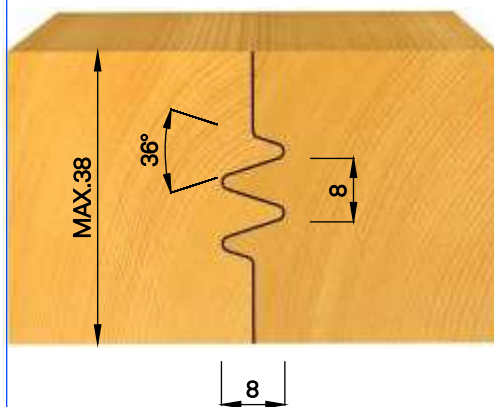

Ricambi / Spare parts / Rechanges / Repuestos / Ersatzteile

Inserto

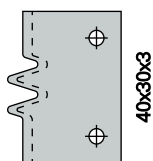

COD.

048028C003

Supporto

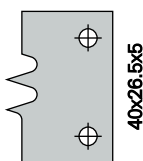

COD.

048028C001

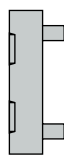

COD.

04805138F0



COD.

0480701020



COD.

048073B000

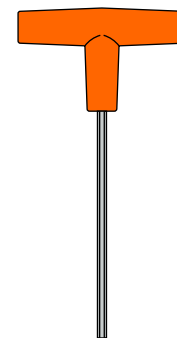

COD.

048078L500



Glue jointing cutter head.



Cabezal para ensamble.



Porte - outil pour abouter.



Verleim - Messerkopf.

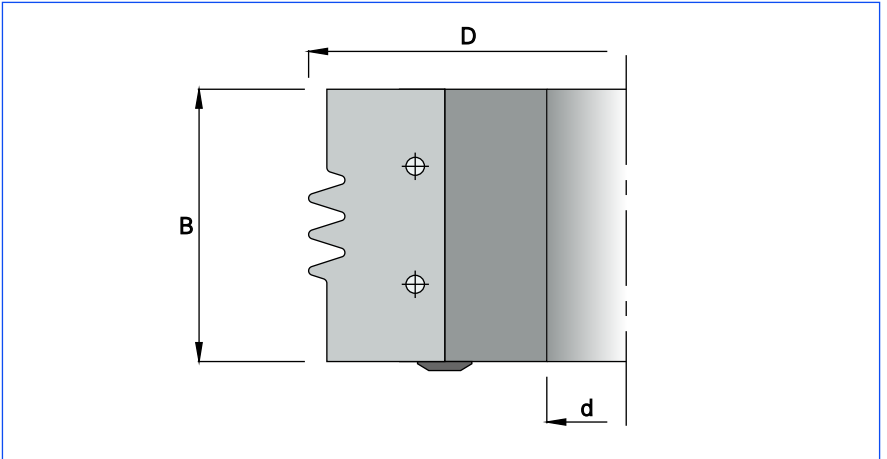

**HW**      **MEC**

n max 7000

D	B	d	Z	COD.
140	60	30	3	0428D00030
140	60	35	3	0428D00035
140	60	40	3	0428D00040
140	60	50	3	0428D00050

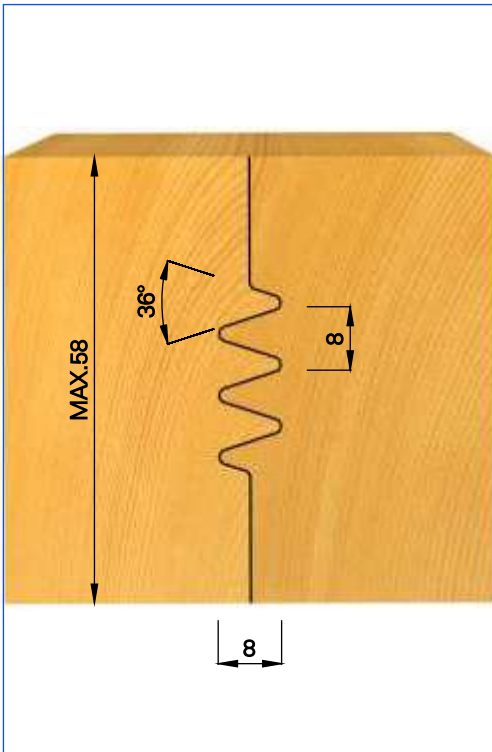

Ricambi / Spare parts / Rechanges / Repuestos / Ersatzteile

 Inserto COD. 048028D003	 Supporto COD. 048028D001	 COD. 04805158F0	 COD. 0480701020	 COD. 048073B000	 COD. 048078L500
--------------------------------	---------------------------------	---------------------	---------------------	---------------------	---------------------

Glue jointing cutter head.

Cabezal para ensamble.

Porte - outil pour abouter.

Verleim - Messerkopf.



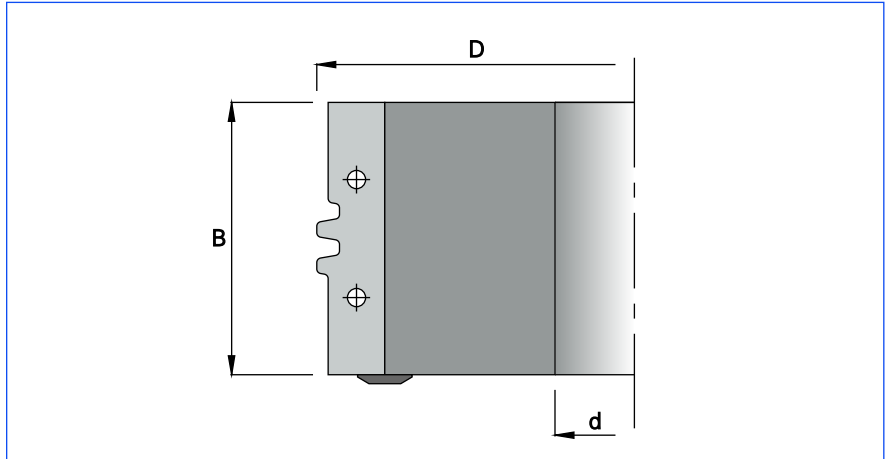

**HW**      **MAN**

n 5500 - 9500

D	B	d	Z	COD.
140	60	30	2	K428E00030
140	60	35	2	K428E00035
140	60	40	2	K428E00040
140	60	50	2	K428E00050

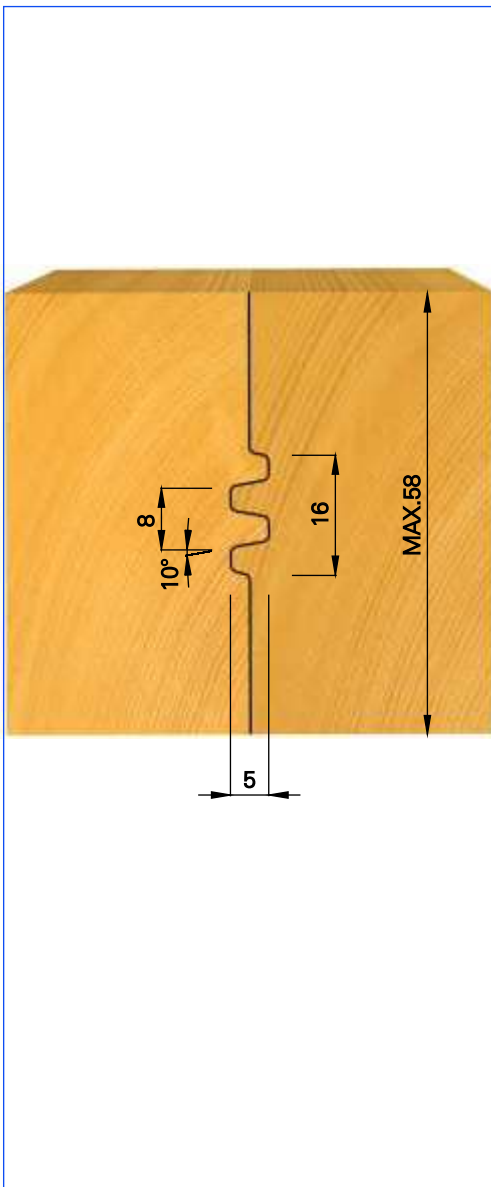

**Ricambi / Spare parts / Rechanges / Repuestos / Ersatzteile**

60x15x1.5			
COD.	COD.	COD.	COD.
K48028E000	048050AET0	048060C000	0480700612
COD.	COD.		
048073B000	0480783000		

Glue jointing cutter head.

Cabezal para ensamble.

Porte - outil pour abouter.

Verleim - Messerkopf.

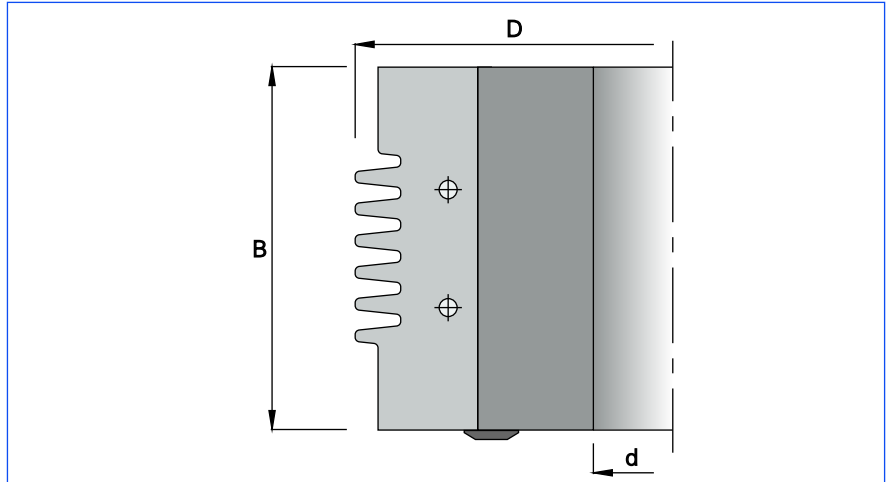

**HW**

**MAN**

n 5500 - 9500

D	B	d	Z	COD.
140	80	30	3	K428F00030
140	80	35	3	K428F00035
140	80	40	3	K428F00040
140	80	50	3	K428F00050

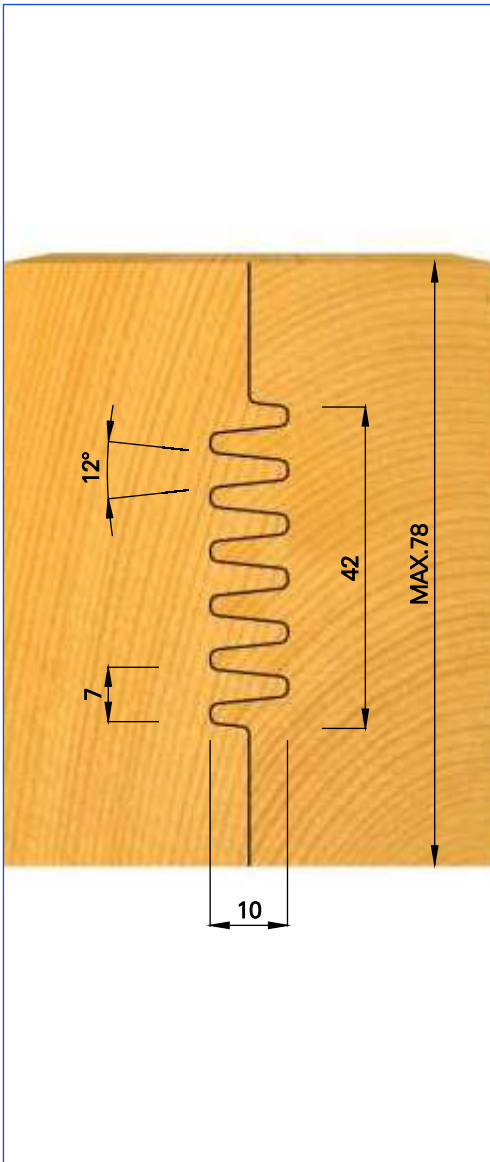

### Ricambi / Spare parts / Rechanges / Repuestos / Ersatzteile

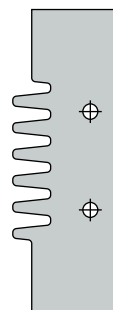

80x27x3

COD.

K48028F000

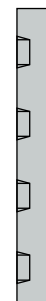

COD.

0480527825



COD.

0480700820



COD.

048073B000

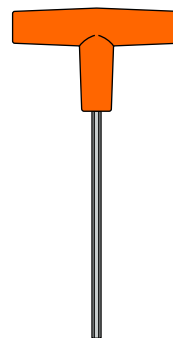

COD.

048078L400

 Glue jointing cutter head.

 Cabezal para ensamble.

 Porte - outil pour abouter.

 Verleim - Messerkopf.

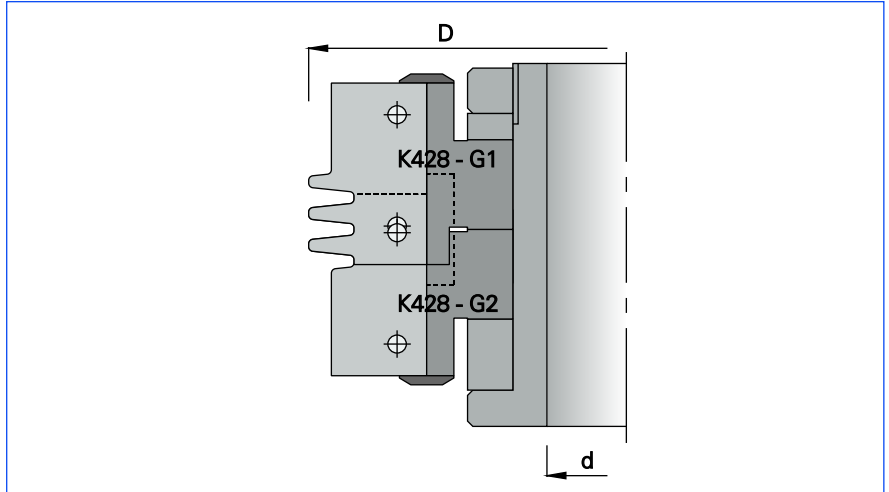

**HW**





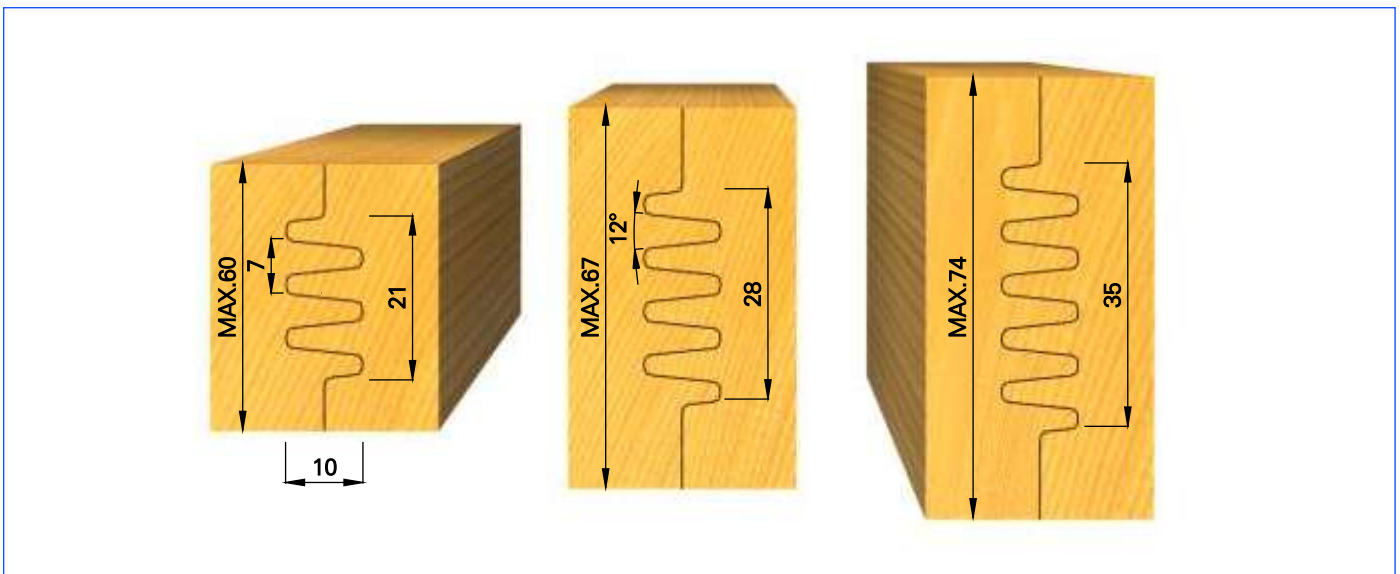

**MAN**

n 5100 - 8900

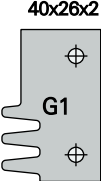
D	d	Z	COD.
150	30	2	K428G00030
150	31.75	2	K428G00031
150	35	2	K428G00035
150	40	2	K428G00040
150	50	2	K428G00050

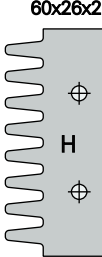

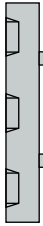
Ricambi / Spare parts / Rechanges / Repuestos / Ersatzteile

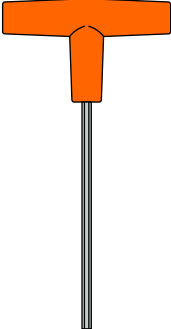
							
COD. K48028G100	COD. K48028G200	COD. K48028H000	COD. 0480523825	COD. 0480525825	COD. 0480700820	COD. 048073B000	COD. 048078L400

 Adjustable glue jointing cutter heads.

 Cabezales para ensamble extensible.

 Porte - outils pour abouter extensibles.

 Verstellbar - Verleim - Messerköpfe.

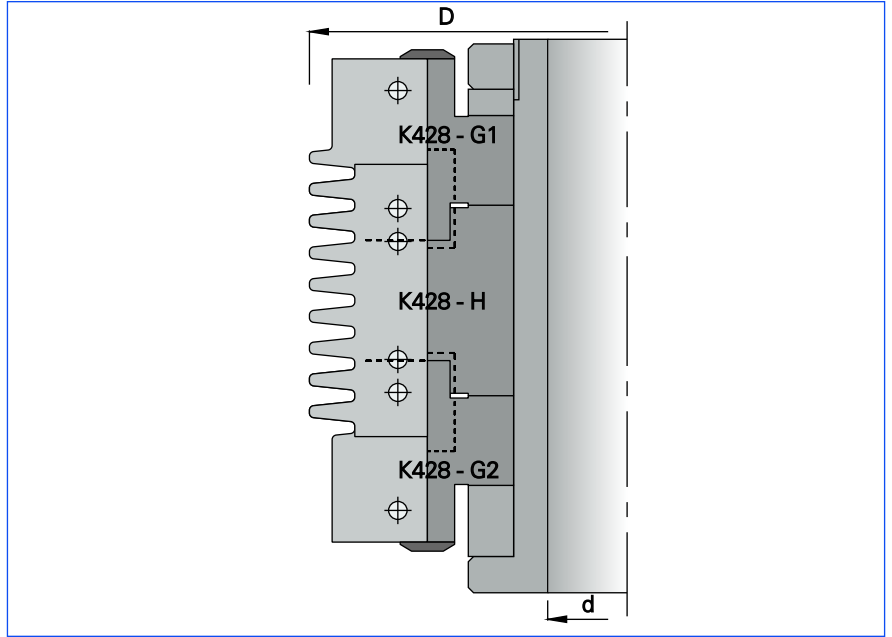



**HW**

**MAN**

n 5100 - 8900

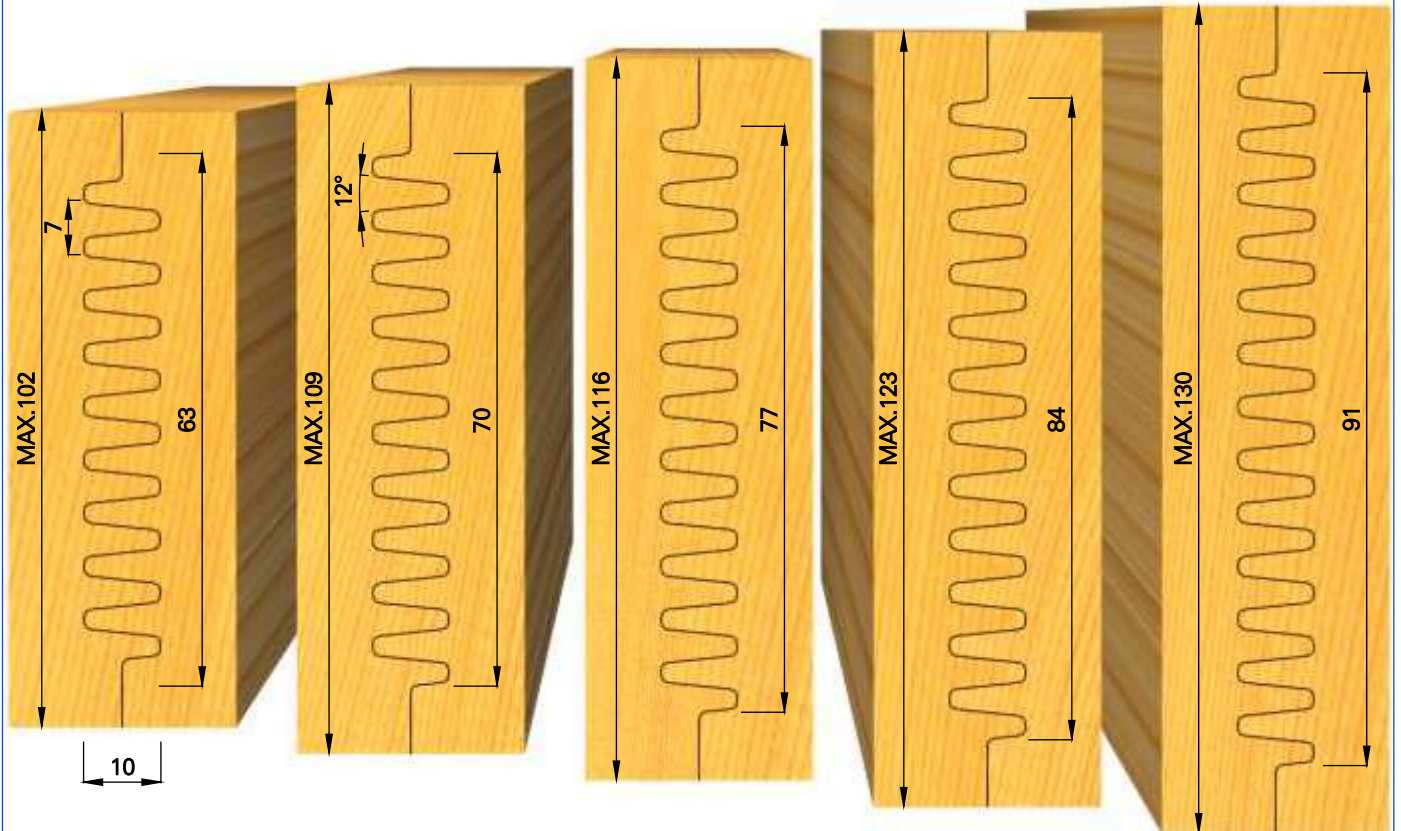
D	d	Z	COD.
150	30	2	K428GH0030
150	31.75	2	K428GH0031
150	35	2	K428GH0035
150	40	2	K428GH0040
150	50	2	K428GH0050



 Adjustable glue jointing cutter heads.

 Cabezales para ensamble extensible.

 Porte - outils pour abouter extensibles.

 Verstellbar - Verleim - Messerköpfe.

# K 428 - R Teste per giunzioni regolabili con anelli

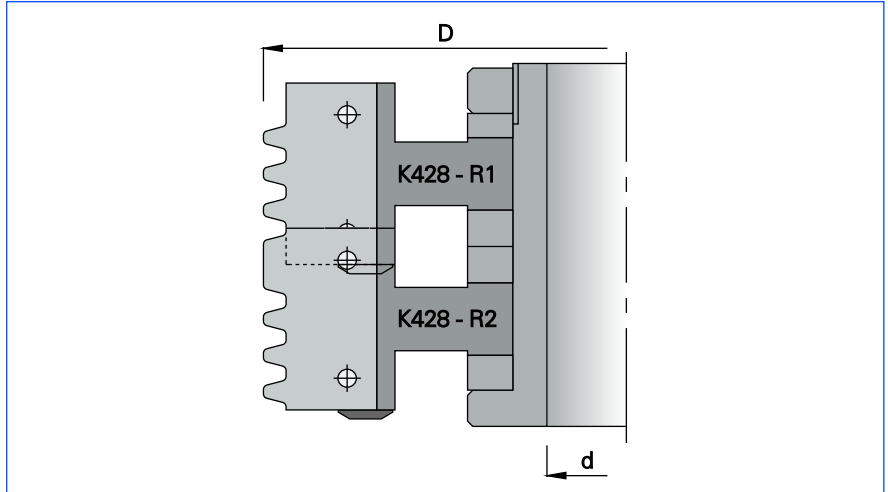

**HW**

**MAN**



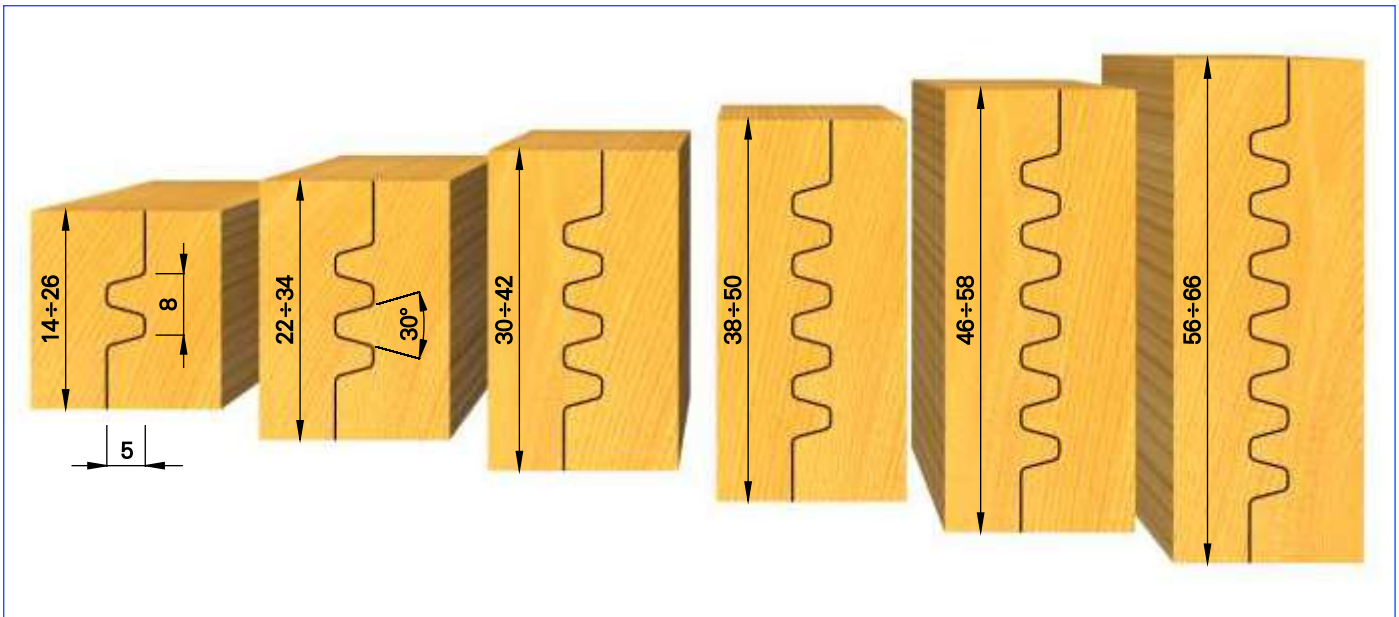

n 4800 - 8300

D	d	Z	COD.
160	30	2	K428R00030
160	31.75	2	K428R00031
160	35	2	K428R00035
160	40	2	K428R00040
160	50*	2	K428R00050

\* Senza mozzo / Without sleeve / Sans manchon / Sin casquillo / Ohne Spannbuchse.

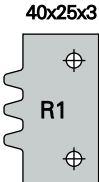
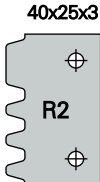

## Ricambi / Spare parts / Rechanges / Repuestos / Ersatzteile

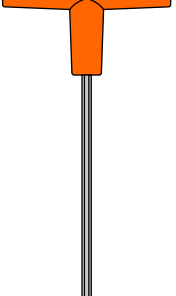
					
COD. K48028R100	COD. K48028R200	COD. 0480523825	COD. 0480700820	COD. 048073B000	COD. 048078L400

 Adjustable glue jointing cutter heads.

 Cabezales para ensamble extensible.

 Porte - outils pour abouter extensibles.

 Verstellbar - Verleim - Messerköpfe.

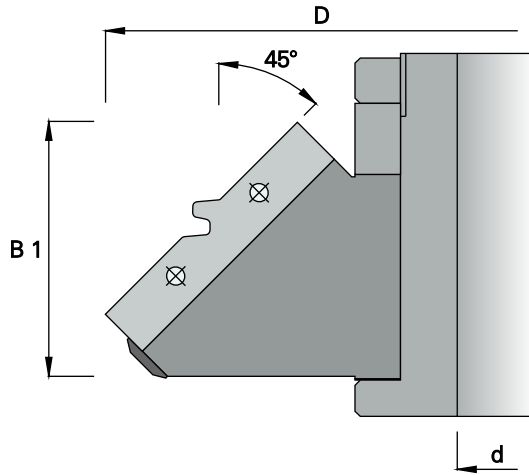

**HW**

**MAN**

n 4300 - 7400

D	B 1	d	Z	COD.
180	56	30	2	K428T00030
180	56	31.75	2	K428T00031
180	56	35	2	K428T00035
180	56	40	2	K428T00040
180	56	50*	2	K428T00050

\* Senza mozzo / Without sleeve / Sans manchon / Sin casquillo / Ohne Spannbuchse.

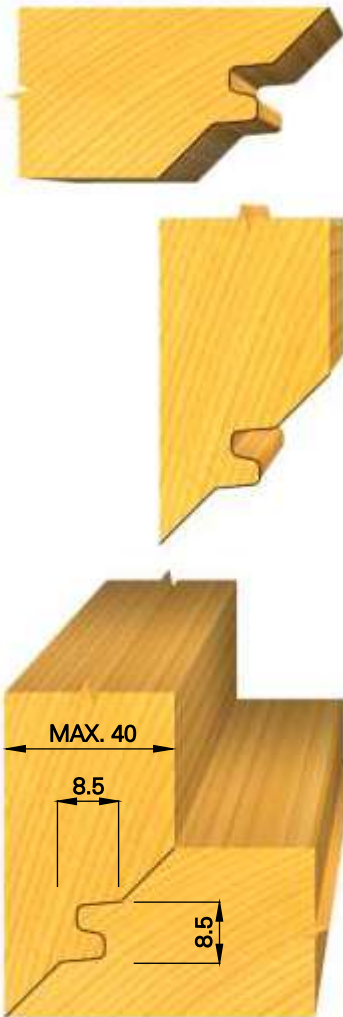

### Ricambi / Spare parts / Rechanges / Repuestos / Ersatzteile

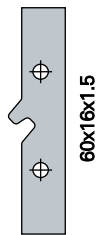

COD.

K48028T000



COD.

048050AET0



COD.

048060C000



COD.

0480700612



COD.

048073B000

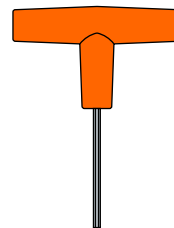

COD.

0480783000

 45° Mitre glue jointing cutter head.

 Cabezal para ensamble de inglete 45°.

 Porte - outil pour bouvetage d' angle 45°.

 Messerkopf zur Gehrungsverbindung 45°.

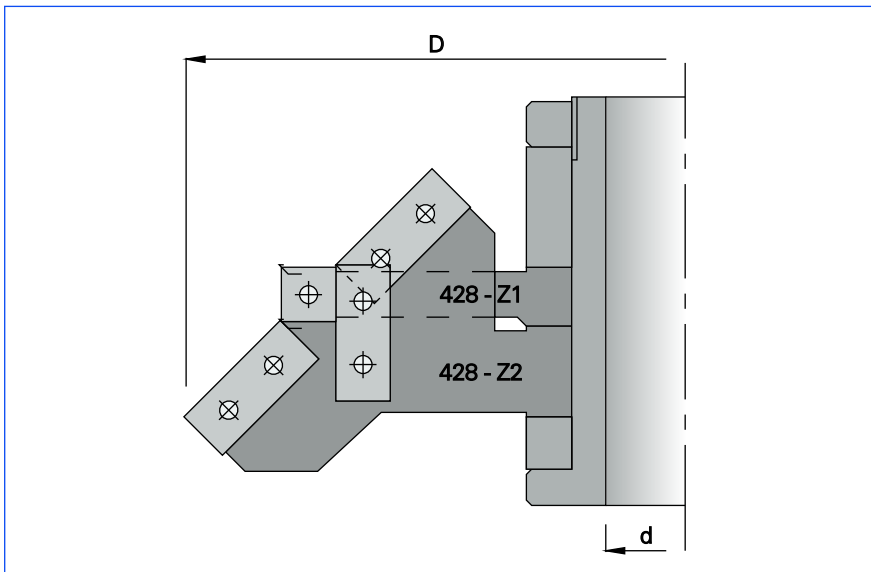

**HW**

**MEC**

n max 6000

D	d	Z	V	COD.
220	30	4+2	2+2	0428Z00030
220	31.75	4+2	2+2	0428Z00031
220	35	4+2	2+2	0428Z00035
220	40	4+2	2+2	0428Z00040
220	50*	4+2	2+2	0428Z00050

\* Senza mozzo / Without sleeve / Sans manchon / Sin casquillo / Ohne Spannbuchse.

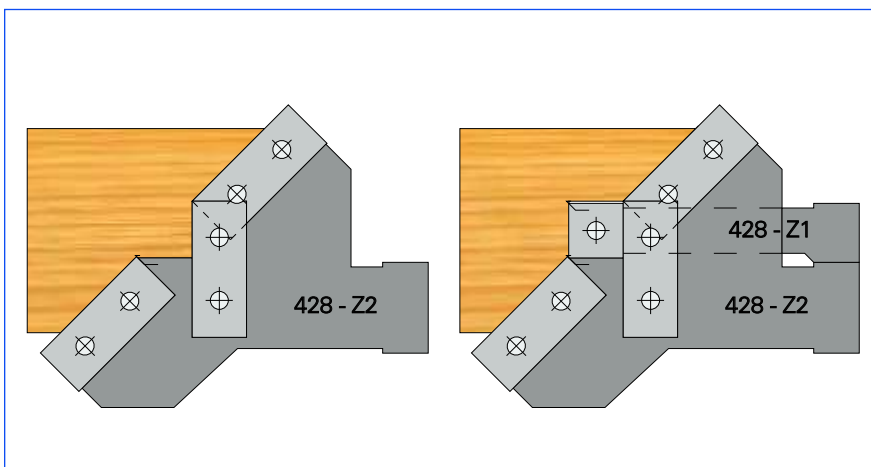
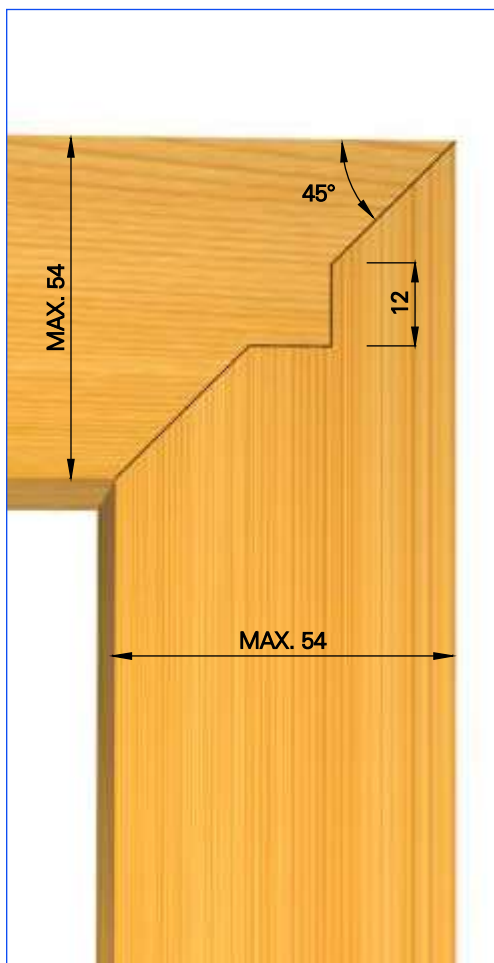

Ricambi / Spare parts / Rechanges / Repuestos / Ersatzteile

COD.	COD.	COD.	COD.	COD.	COD.
0480030014	0480050012	0480050030	0480501000		
COD.	COD.	COD.	COD.	COD.	COD.
0480502600	048060C000	0480700612	048074A510	0480783000	048078T200

45° Mitre glue jointing cutter head set.

Juego de cabezales para ensamble de inglete 45°.

Jeu de porte - outil pour bouvetage d' angle 45°.

Messerkopfsatz zur Gehrungsverbindung 45°.

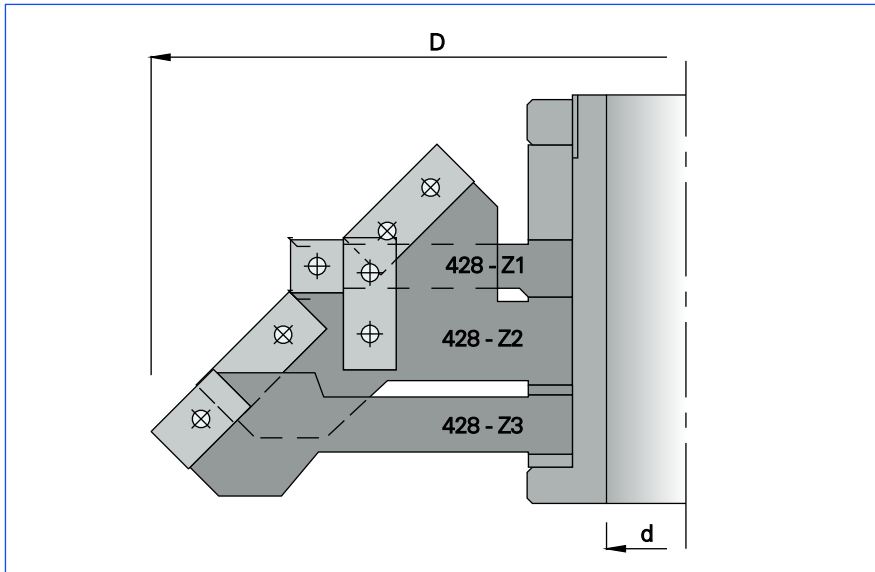

**HW**

**MEC**

n max 5400

D	d	Z	V	COD.
242	30	4+2	2+2	0428ZH0030
242	31.75	4+2	2+2	0428ZH0031
242	35	4+2	2+2	0428ZH0035
242	40	4+2	2+2	0428ZH0040
242	50*	4+2	2+2	0428ZH0050

\* Senza mozzo / Without sleeve / Sans manchon / Sin casquillo / Ohne Spannbuchse.

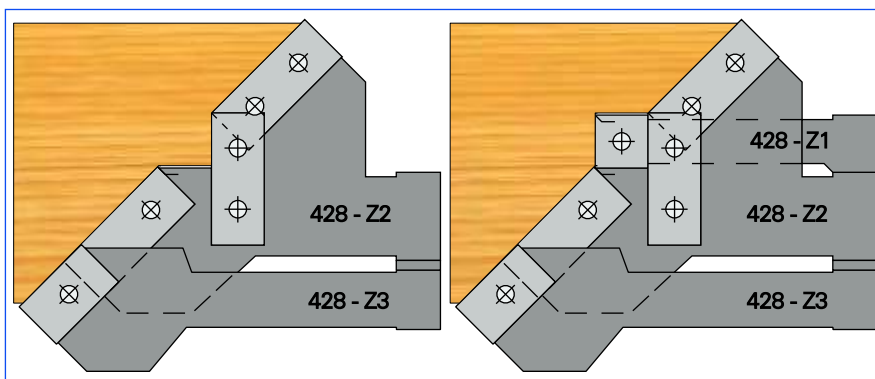
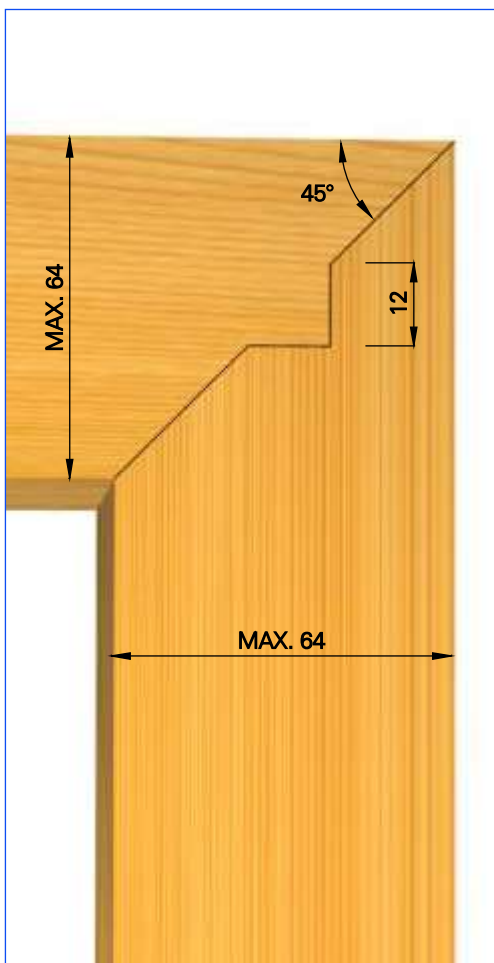

### Ricambi / Spare parts / Rechanges / Repuestos / Ersatzteile

COD.	COD.	COD.	COD.	COD.	COD.
0480030014	0480050012	0480050020	0480050030	0480501000	0480501800
COD.	COD.	COD.	COD.	COD.	COD.
0480502600	048060C000	0480700612	048074A510	0480783000	048078T200

45° Mitre glue jointing cutter head set.

Juego de cabezales para ensamble de inglete 45°.

Jeu de porte - outil pour bouvetage d' angle 45°.

Messerkopfsatz zur Gehrungsverbindung 45°.





**HW**

**MAN**

D 160 n 4800 - 8300  
D 180 n 4300 - 7400

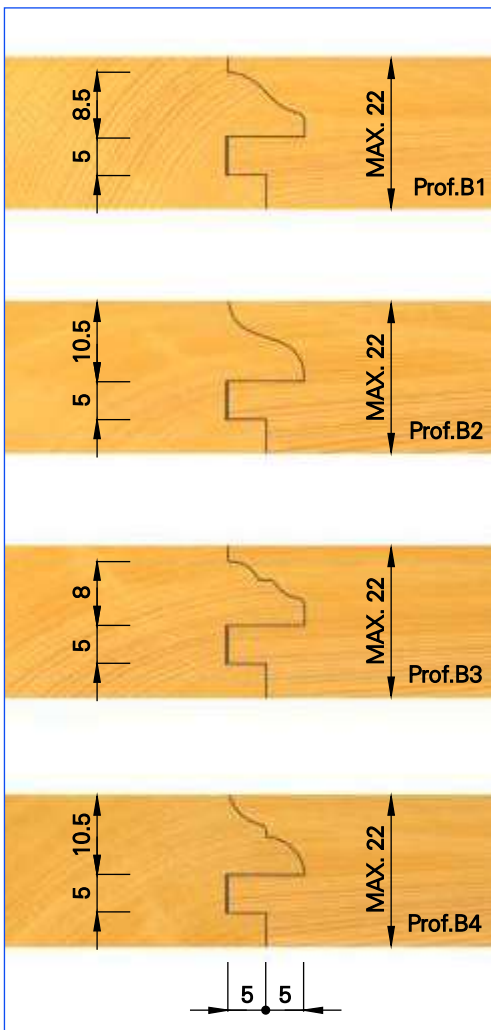
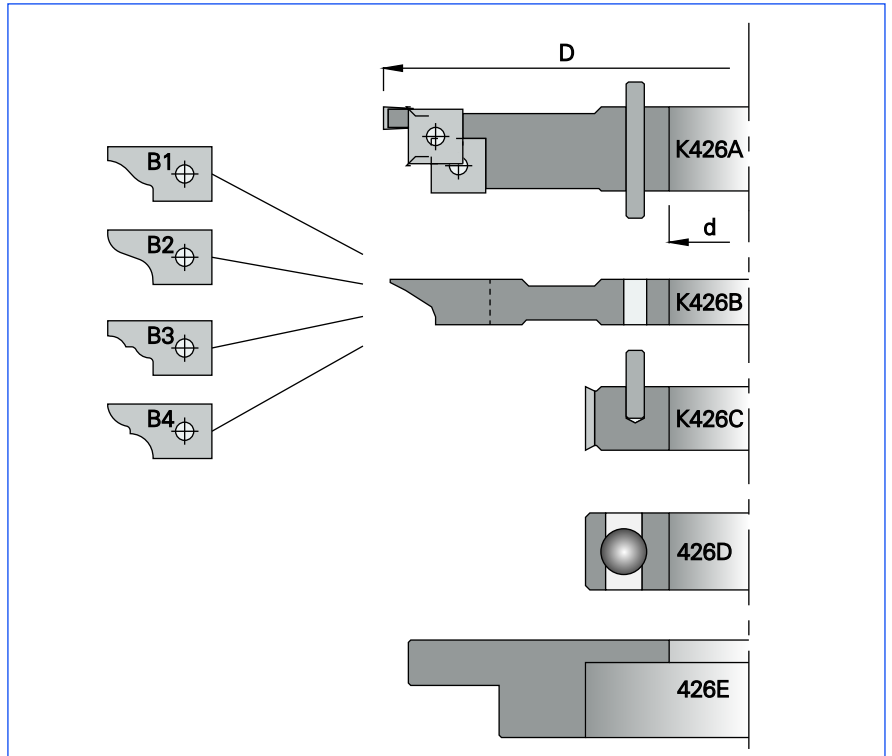

### SET COMPLETO DI INSERTI PER PROFILI B1 - B2 - B3 - B4.

D	d	Z	COD. SET
160	30	2	K426010030
160	31.75	2	K426010031
160	35	2	K426010035
180	40	2	K426010040
180	50	2	K426010050

ART.	D	d		
		30 COD.	31.75 COD.	35 COD.
K426 - A	160	K426A00030	K426A00031	K426A00035
K426 - B*	160	K426B00030	K426B00031	K426B00035
K426 - C	72	K426C00030	K426C00031	K426C00035
426 - D	72	0426D00030	0426D00031	0426D00035
426 - E	150	0426E00030	0426E00031	0426E00035

ART.	D	d	
		40 COD.	50 COD.
K426 - A	180	K426A00040	K426A00050
K426 - B*	180	K426B00040	K426B00050
K426 - C	90	K426C00040	K426C00050
426 - D	90	0426D00040	0426D00050
426 - E	170	0426E00040	0426E00050

\* Senza inserti / Without inserts / Sans plaquettes / Sin cuchillas / Ohne Messer.



Multi - profile cutter head set for cabinet doors, complete with profiled inserts B1 - B2 - B3 - B4.



Juego de cabezales multiperfiles para puertas de muebles, completo con cuchillas perfiladas B1 - B2 - B3 - B4.



Jeu de porte - outils multiprofiles pour portes de meubles, complet avec plaquettes profilées B1 - B2 - B3 - B4.



Multi - Profiler Messerkopfsatz für Möbeltüren, komplett mit Profilmessern B1 - B2 - B3 - B4.

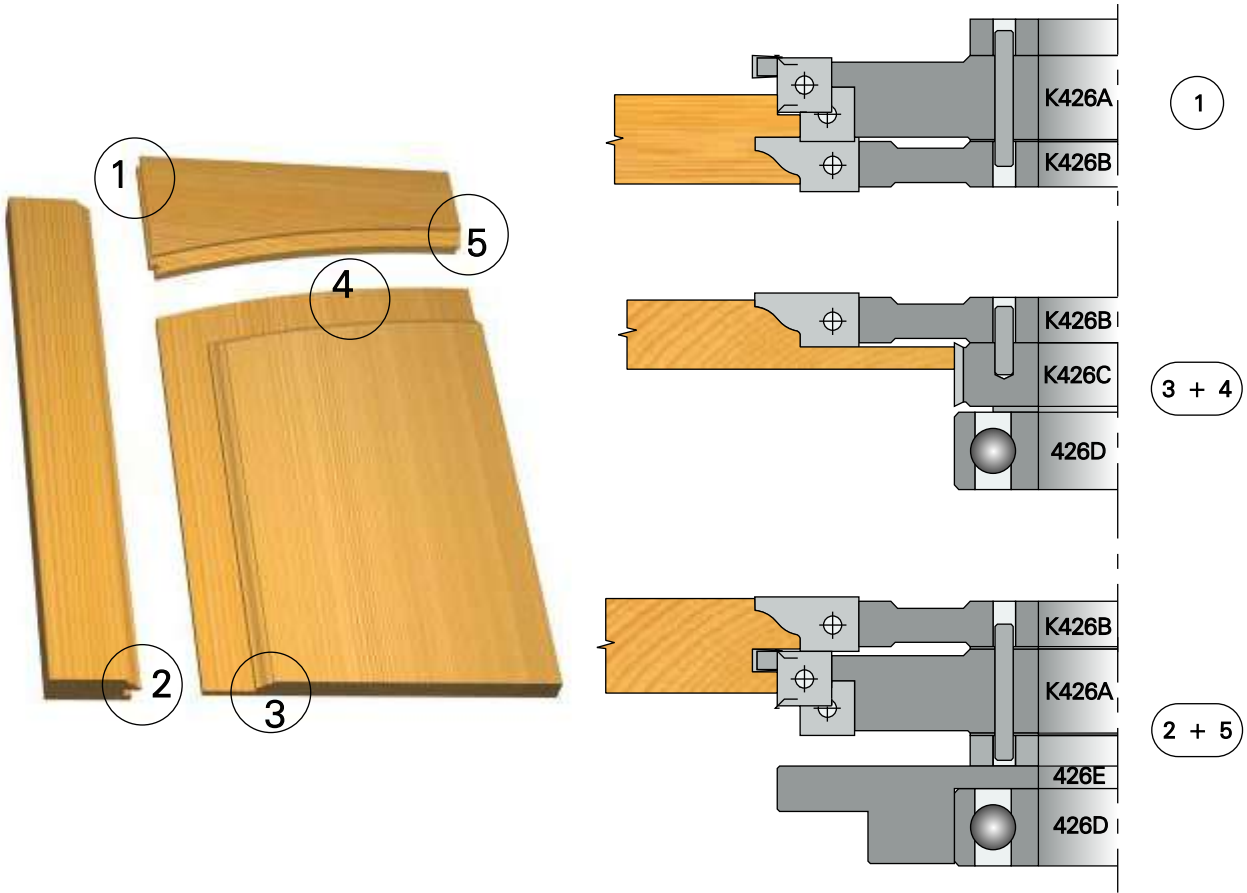

## Ricambi / Spare parts / Rechanges / Repuestos / Ersatzteile



COD.  
0480030014



COD.  
0480050012

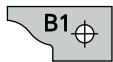

COD.  
K48026B100

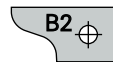

COD.  
K48026B200

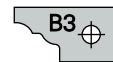

COD.  
K48026B300

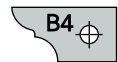

COD.  
K48026B400



COD.  
0480501000



COD.  
048053B000



COD.  
048060B000



COD.  
0480700512



COD.  
0480700615

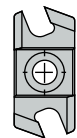

COD.  
K48017F000



COD.  
048074A510



COD.  
048074C515



COD.  
0480791000

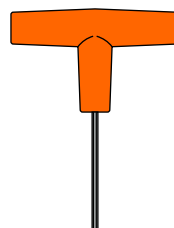

COD.  
0480782500

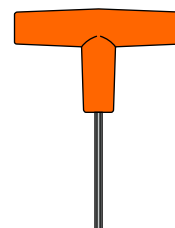

COD.  
0480783000

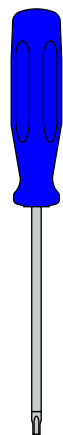

COD.  
048078T200



**HW**

**MAN**

n 4800 - 8300

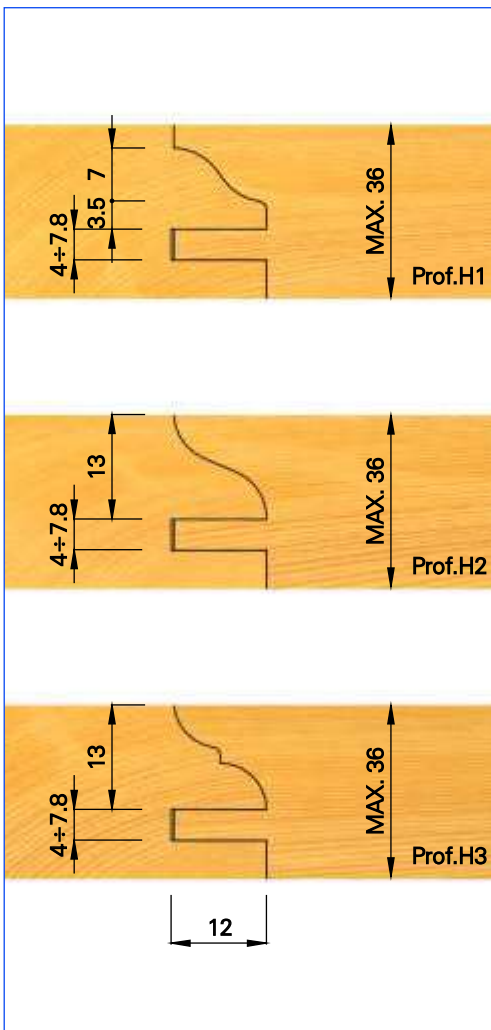
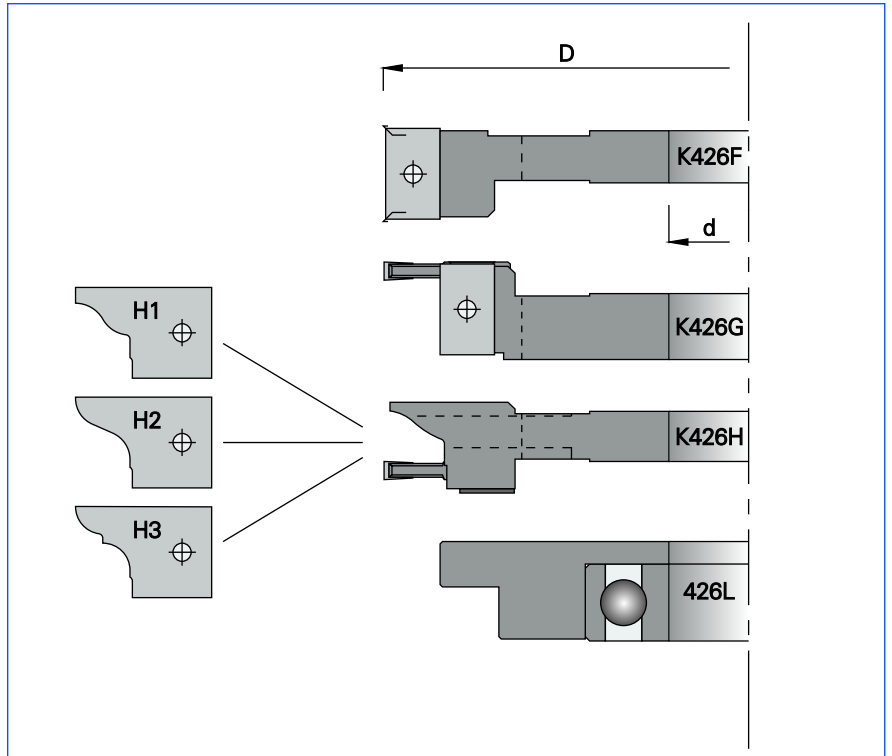

### SET COMPLETO DI INSERTI PER PROFILI H1 - H2 - H3.

D	d	Z	COD. SET
160	30	2	K426020030
160	31.75	2	K426020031
160	35	2	K426020035
160	40	2	K426020040
160	50	2	K426020050

ART.	d 30 COD.	d 31.75 COD.	d 35 COD.	d 40 COD.	d 50 COD..
K426 - F	K426F00030	K426F00031	K426F00035	K426F00040	K426F00050
K426 - G	K426G00030	K426G00031	K426G00035	K426G00040	K426G00050
K426 - H*	K426H00030	K426H00031	K426H00035	K426H00040	K426H00050
426 - L	0426L00030	0426L00031	0426L00035	0426L00040	0426L00050

\* Senza inserti / Without inserts / Sans plaquettes / Sin cuchillas / Ohne Messer.



Multi - profile cutter head set for cabinet doors, complete with profiled inserts H1 - H2 - H3.



Juego de cabezales multiperfiles para puertas de muebles, completo con cuchillas perfiladas H1 - H2 - H3.



Jeu de porte - outils multiprofiles pour portes de meubles, complet avec plaquettes profilées H1 - H2 - H3.



Multi - Profiler Messerkopfsatz für Möbeltüren, komplett mit Profilmessern H1 - H2 - H3.

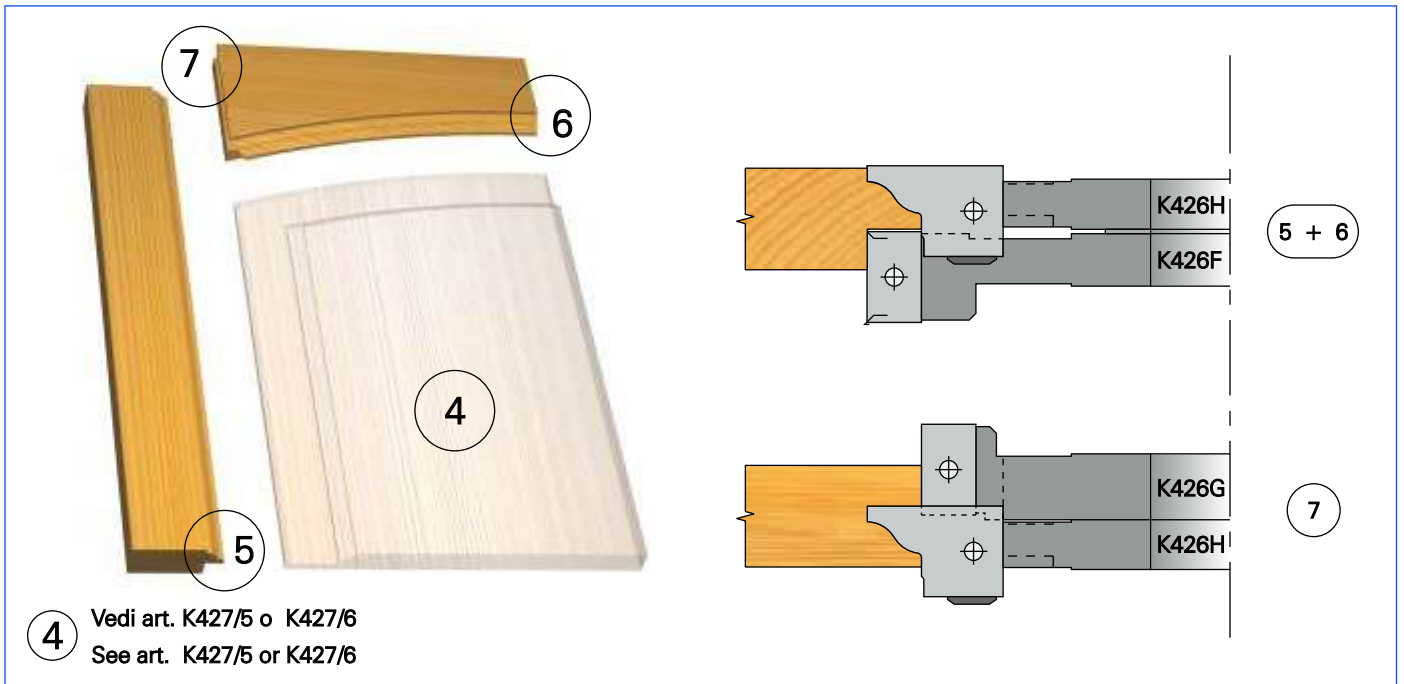
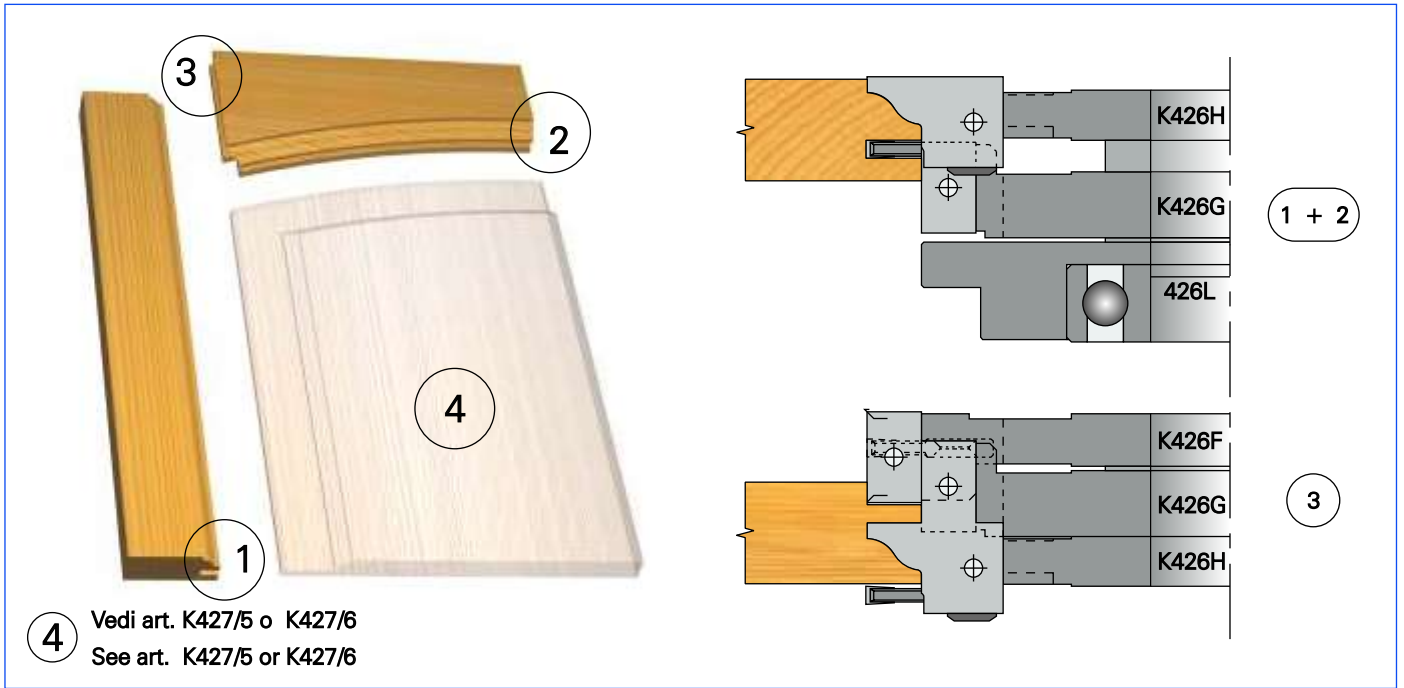

## Ricambi / Spare parts / Rechanges / Repuestos / Ersatzteile

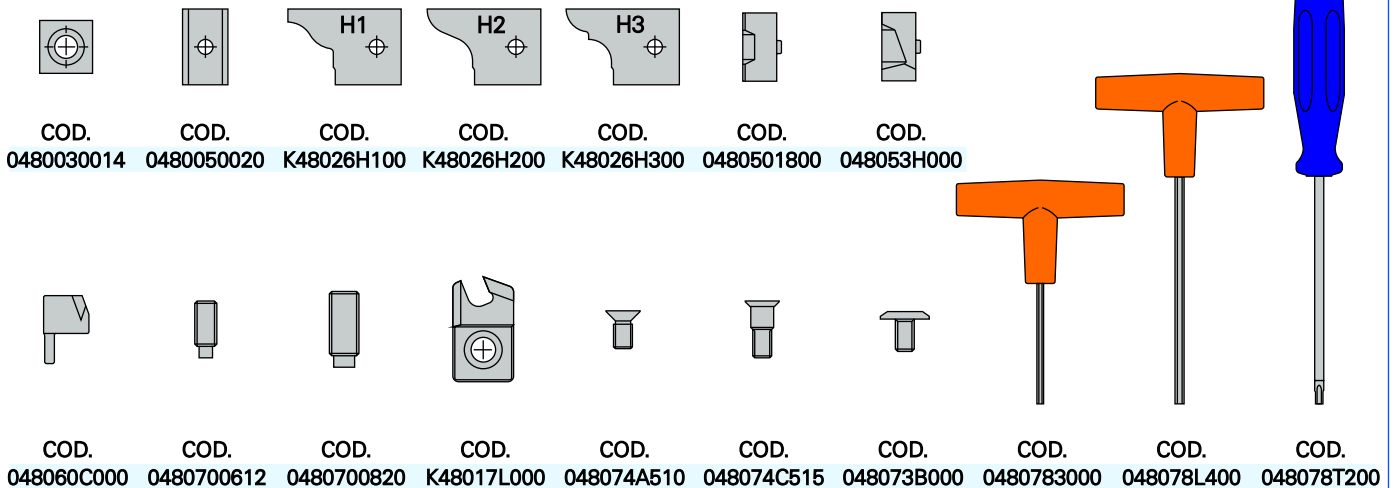

# K 426 - 5P Gruppo di teste multiprofile programmato per antine e porte



**HW**

**MAN**

D 170 n 4500 - 7800  
D 180 n 4300 - 7400

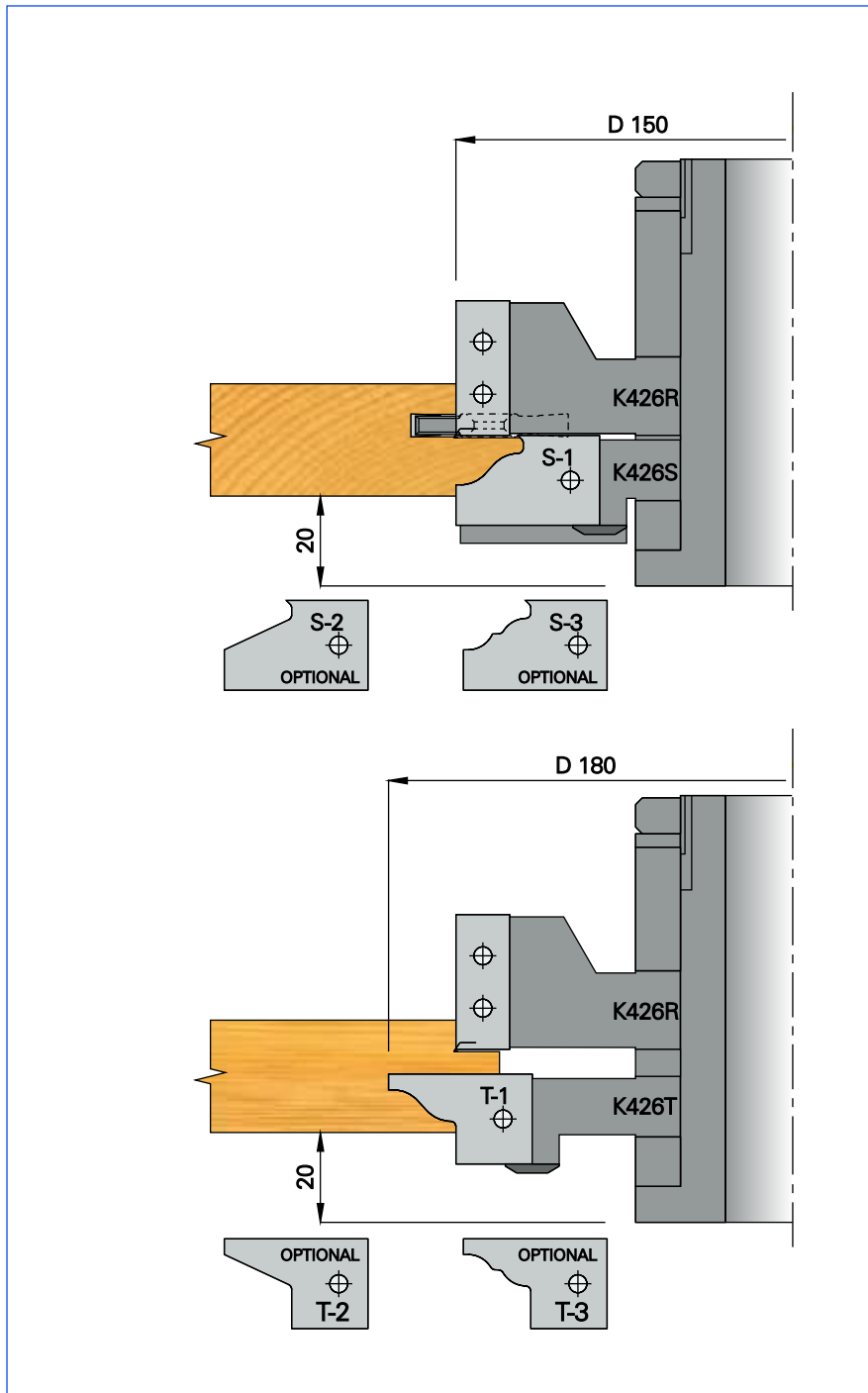
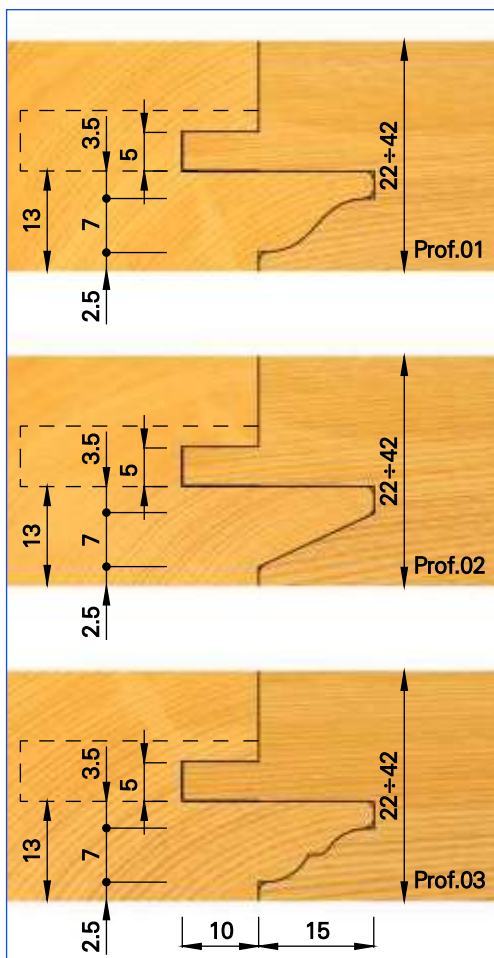

## SET COMPLETO DI INSERTI PER PROFILO 01.

D	d	Z	COD. SET
180	30	2	K42605P030
180	31.75	2	K42605P031
180	35	2	K42605P035
180	40	2	K42605P040
180	50*	2	K42605P050

\* Senza mozzo / Without sleeve / Sans manchon / Sin casquillo / Ohne Spannbuchse.



Multi - profile cutter head set for cabinet and internal doors, complete with profiled inserts S1 - T1.



Juego de cabezales multiperfiles para puertas de muebles, completo con cuchillas perfiladas S1 - T1.



Jeu de porte - outils multiprofiles pour portes de meubles, complet avec plaquettes profilées S1 - T1.



Multi - Profiler Messerkopfsatz für Möbeltüren und Innentüren, komplett mit Profilmessern S1 - T1.

# K 426 - 5P Gruppo di teste multiprofilati programmato per antine e porte

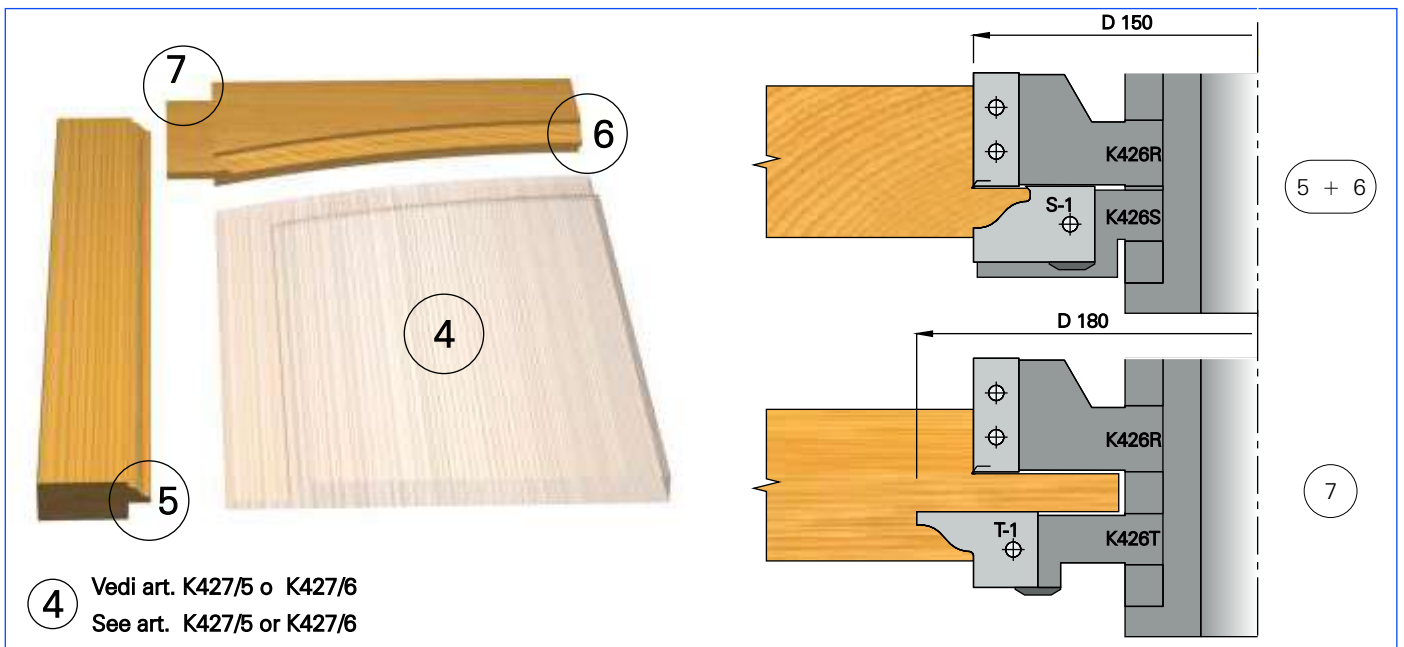
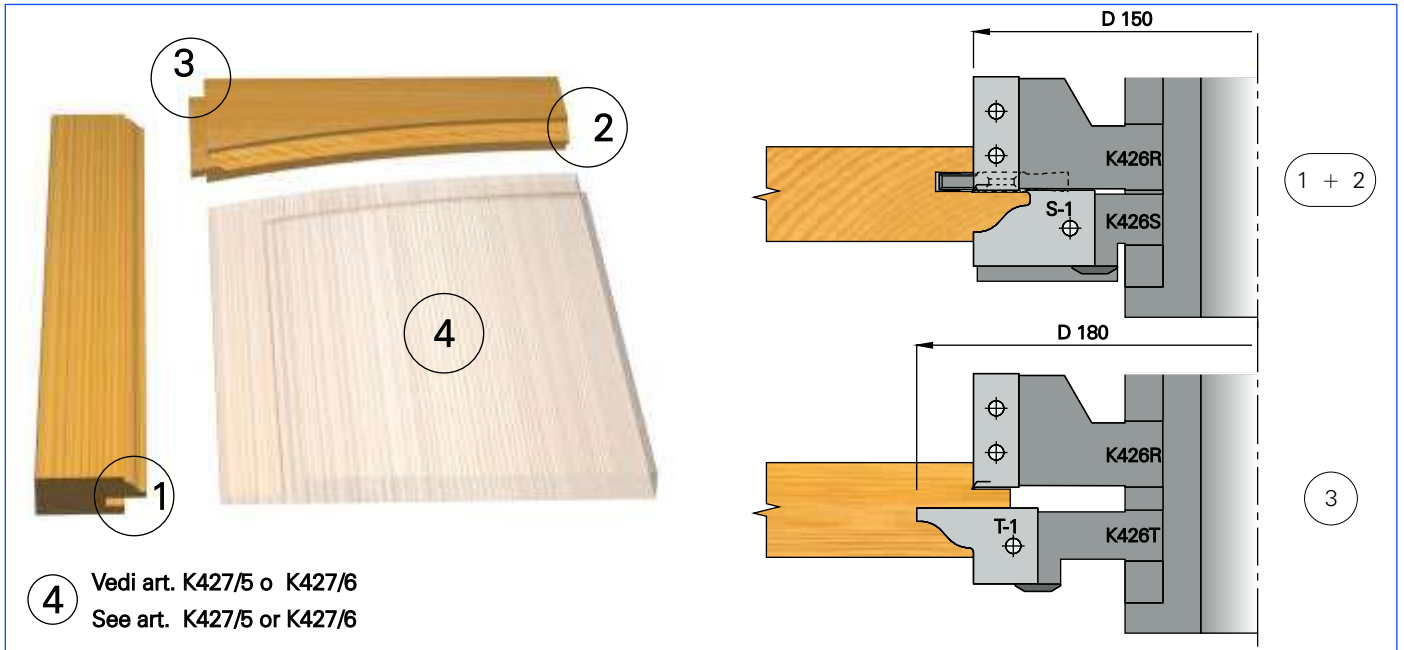

## Ricambi / Spare parts / Rechanges / Repuestos / Ersatzteile

COD.	COD.	COD.	COD.	COD.	COD.	COD.	COD.
0480030014	0480050030	K48026S100	K48026S200	K48026S300	K48026T100	K48026T200	K48026T300
COD.	COD.	COD.	COD.	COD.	COD.	COD.	
0480502600	048053182R	048053182L	048060C000	0480700612	0480700820		
COD.	COD.	COD.	COD.	COD.	COD.	COD.	
048074A510	048074C515	K48017F000	048073B000	0480783000	048078L400	048078T200	

# K 426 - 6P Gruppo di teste multiprofilati programmato per antine e porte



**HW**

**MAN**

D 170 n 4500 - 7800  
D 180 n 4300 - 7400

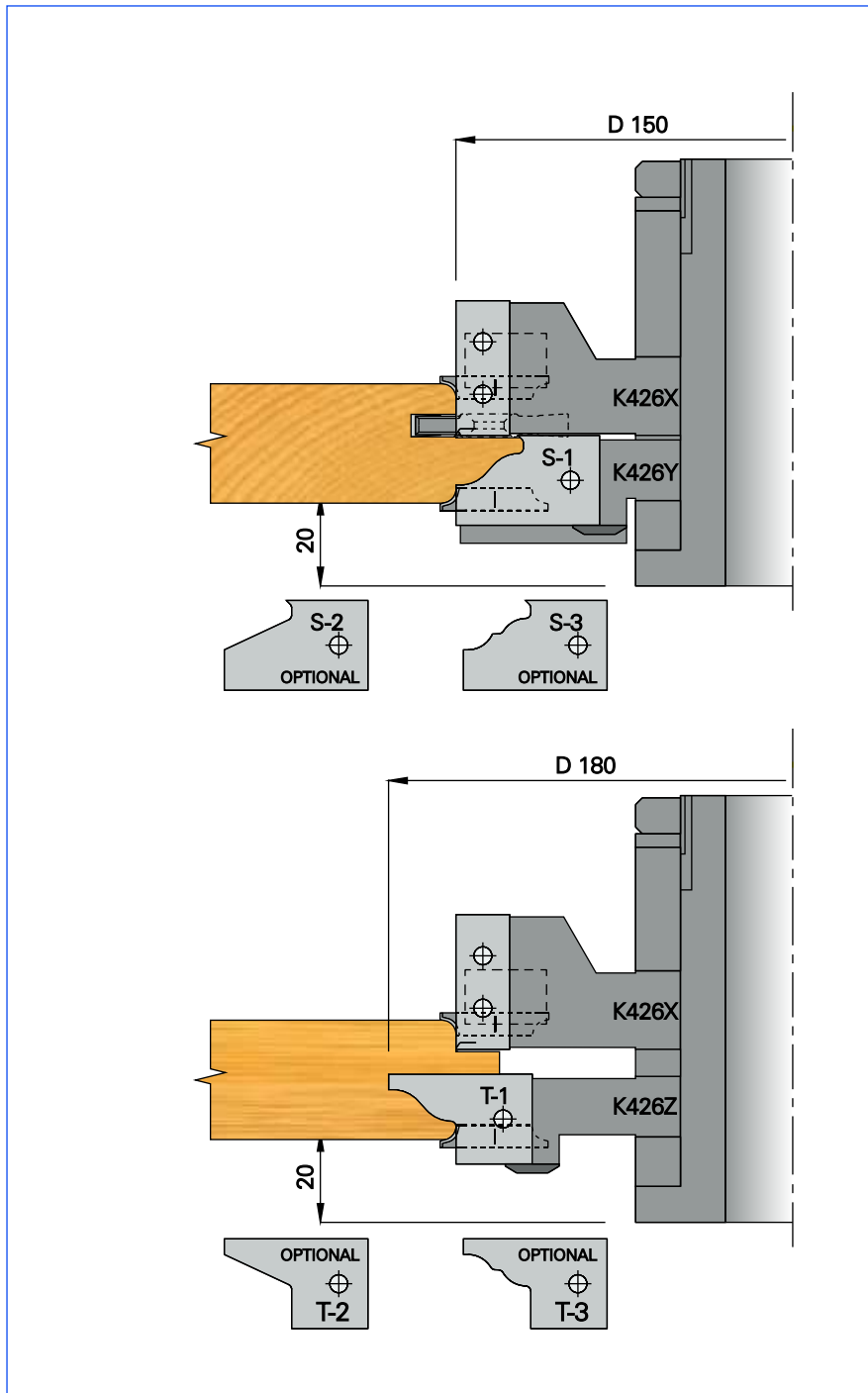
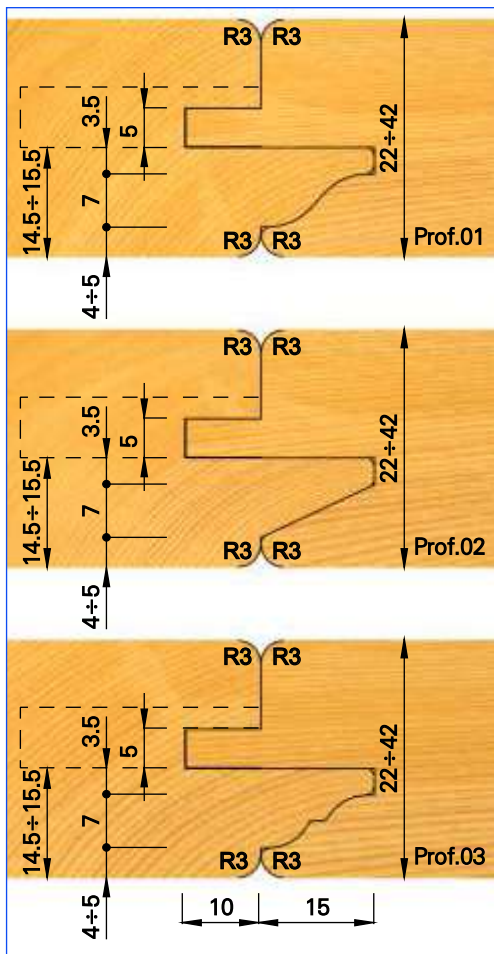

## SET COMPLETO DI INSERTI PER PROFILO 01.

D	d	Z	COD. SET
180	30	2	K42606P030
180	31.75	2	K42606P031
180	35	2	K42606P035
180	40	2	K42606P040
180	50*	2	K42606P050

\* Senza mozzo / Without sleeve / Sans manchon / Sin casquillo / Ohne Spannbuchse.

 Multi - profile cutter head set for cabinet and internal doors, complete with profiled inserts S1 - T1.

 Juego de cabezales multiperfiles para puertas de muebles, completo con cuchillas perfiladas S1 - T1.

 Jeu de porte - outils multiprofiles pour portes de meubles, complet avec plaquettes profilées S1 - T1.

 Multi - Profiler Messerkopfsatz für Möbeltüren und Innentüren, komplett mit Profilmessern S1 - T1.

# K 426 - 6P Gruppo di teste multiprofilati programmato per antine e porte

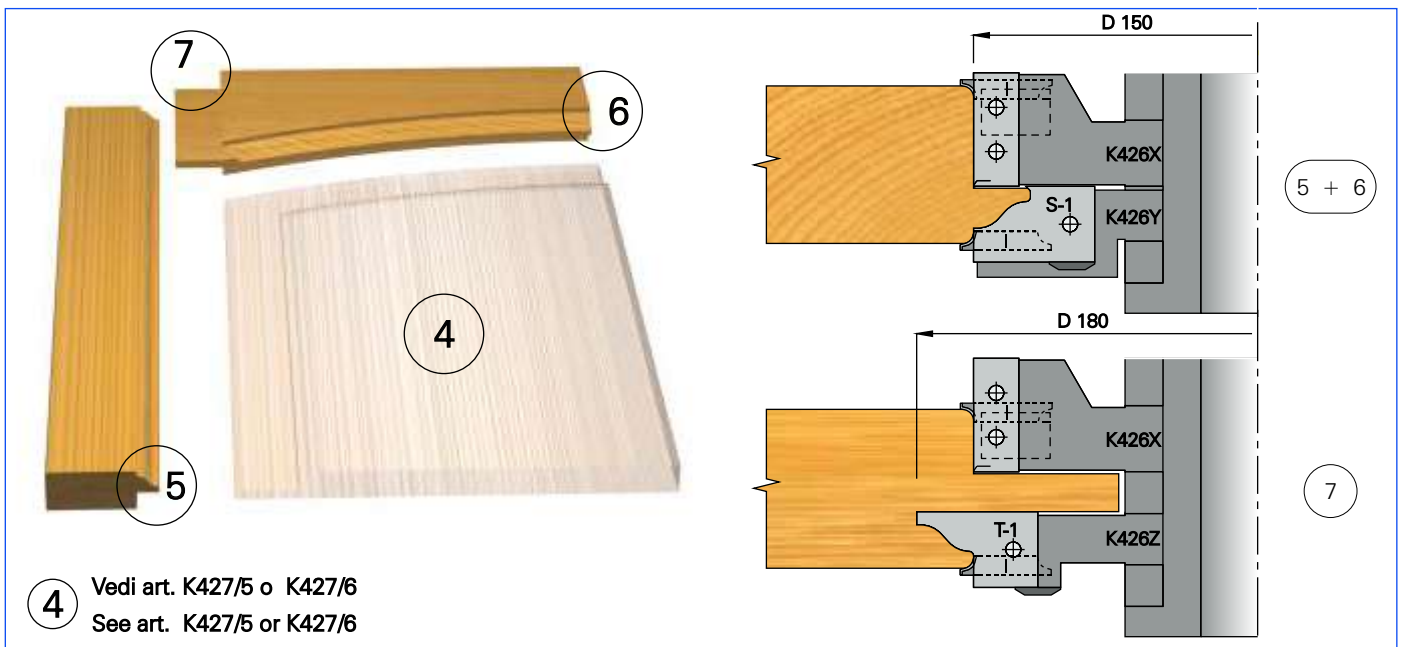
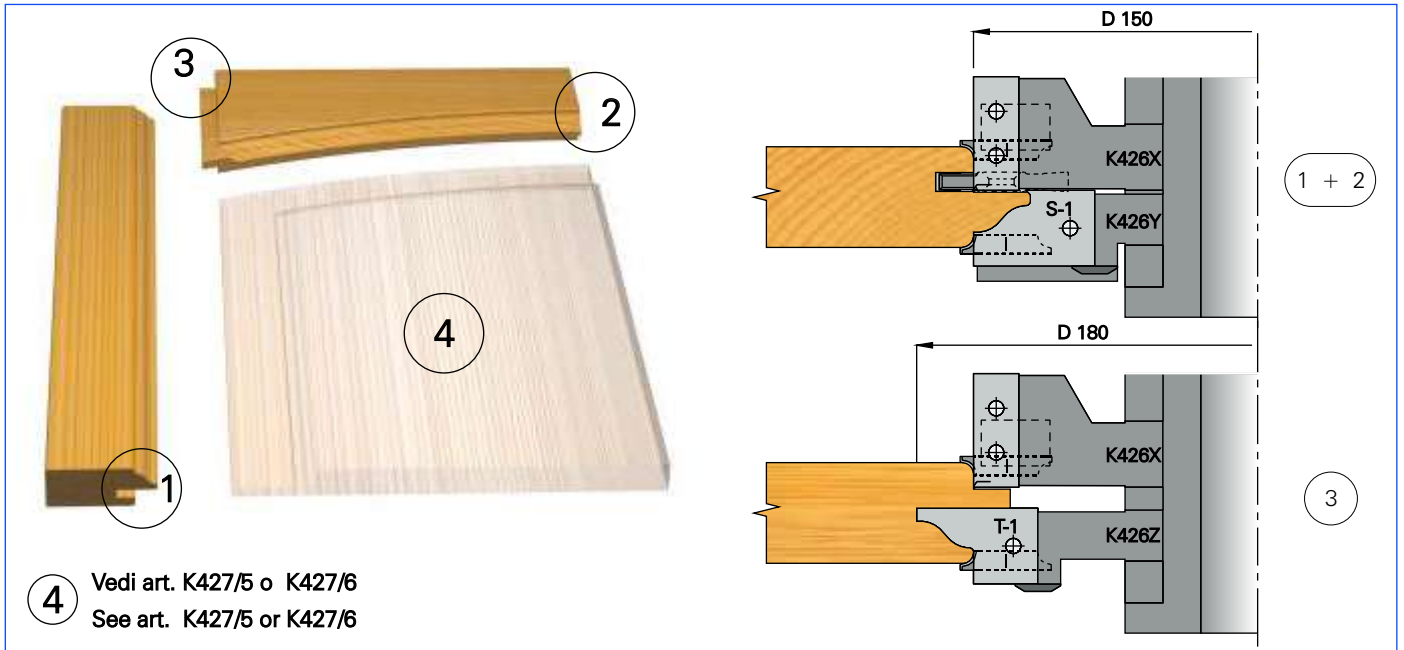

Ricambi / Spare parts / Rechanges / Repuestos / Ersatzteile								
COD. 0480030014	COD. 0480050030	COD. K48026S100	COD. K48026S200	COD. K48026S300	COD. K48026T100	COD. K48026T200	COD. K48026T300	COD. 0480502600
COD. 048053182R	COD. 048053182L	COD. 048060C000	COD. 0480700612	COD. 0480700620	COD. 0480700820	COD. 048074A510	COD. 048074B515	
COD. 048074C515	COD. 048073B000	COD. K48062E000	COD. K480150000	COD. K480160000	COD. K48017F000	COD. 0480783000	COD. 048078L400	COD. 048078T200



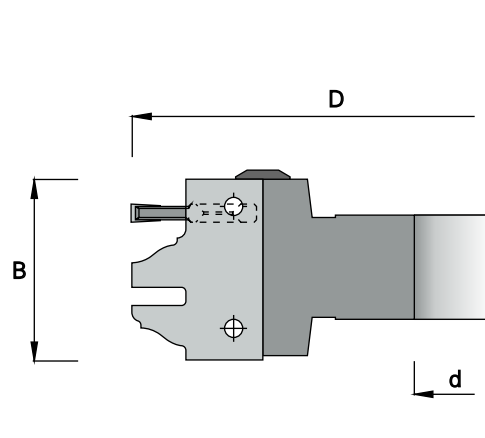

HW

MAN

n 4800 - 8300

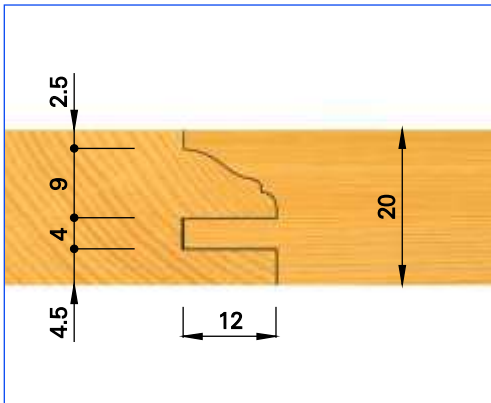

D	B	d	Z	COD.
160	40	30	2	K426P00030
160	40	31.75	2	K426P00031
160	40	35	2	K426P00035
160	40	40	2	K426P00040
160	40	50	2	K426P00050



 Cutter head for cabinet doors.

 Cabezal para puertas de muebles.

 Porte - outil pour portes de meubles.

 Messerkopf für Möbeltüren.

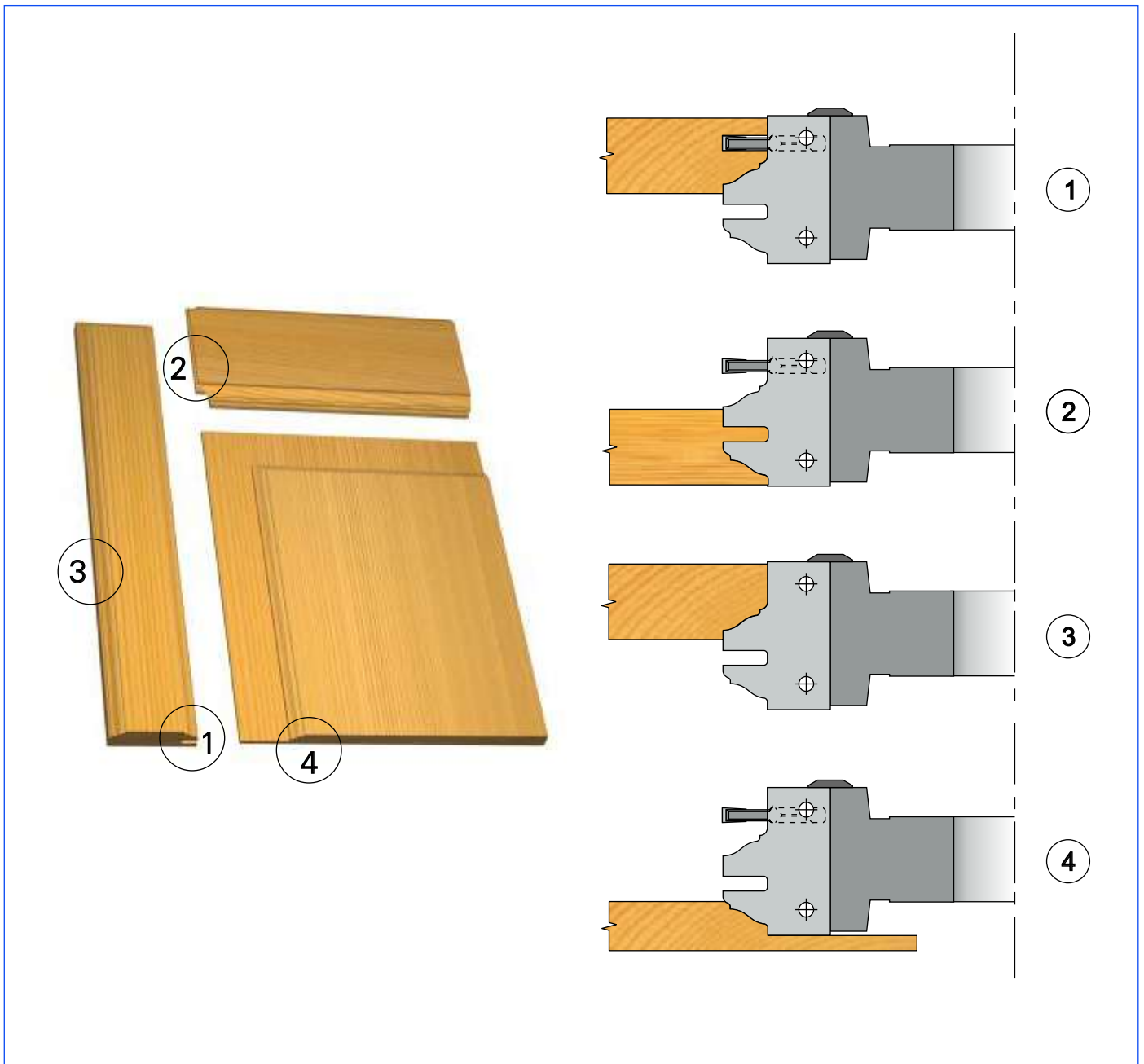

### Ricambi / Spare parts / Rechanges / Repuestos / Ersatzteile

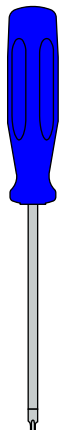
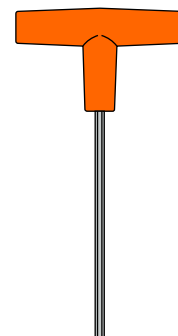
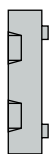
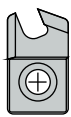
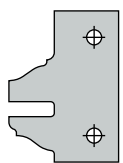

COD.  
K48026P000

COD.  
K48017L000

COD.  
0480523825

COD.  
0480700820

COD.  
048074C515

COD.  
048073B000

COD.  
048078L400

COD.  
048078T200



**HW**

**MAN**

n 6400 - 11100

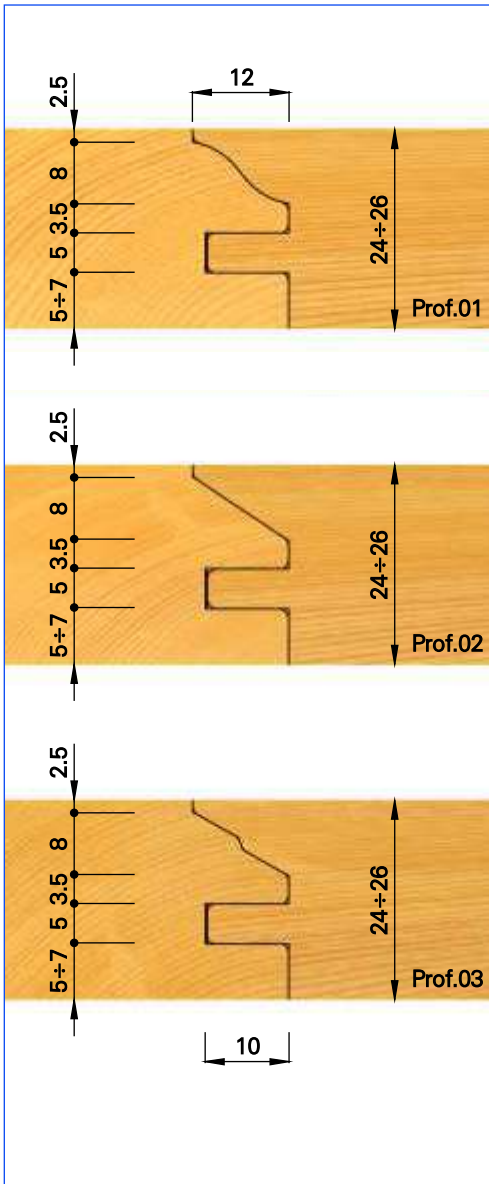
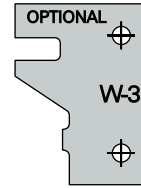
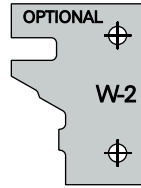
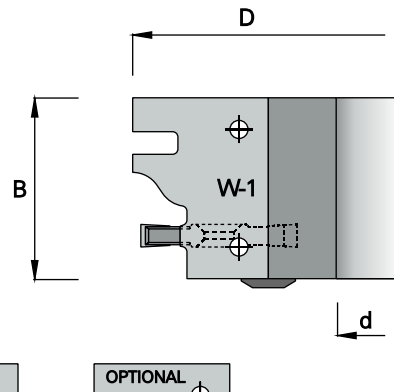

D	B	d	Z	COD.
120	40	30	2	K426W00030
120	40	31.75	2	K426W00031
120	40	35	2	K426W00035



 Cutter head for cabinet doors.

 Cabezal para puertas de muebles.

 Porte - outil pour portes de meubles.

 Messerkopf für Möbeltüren.

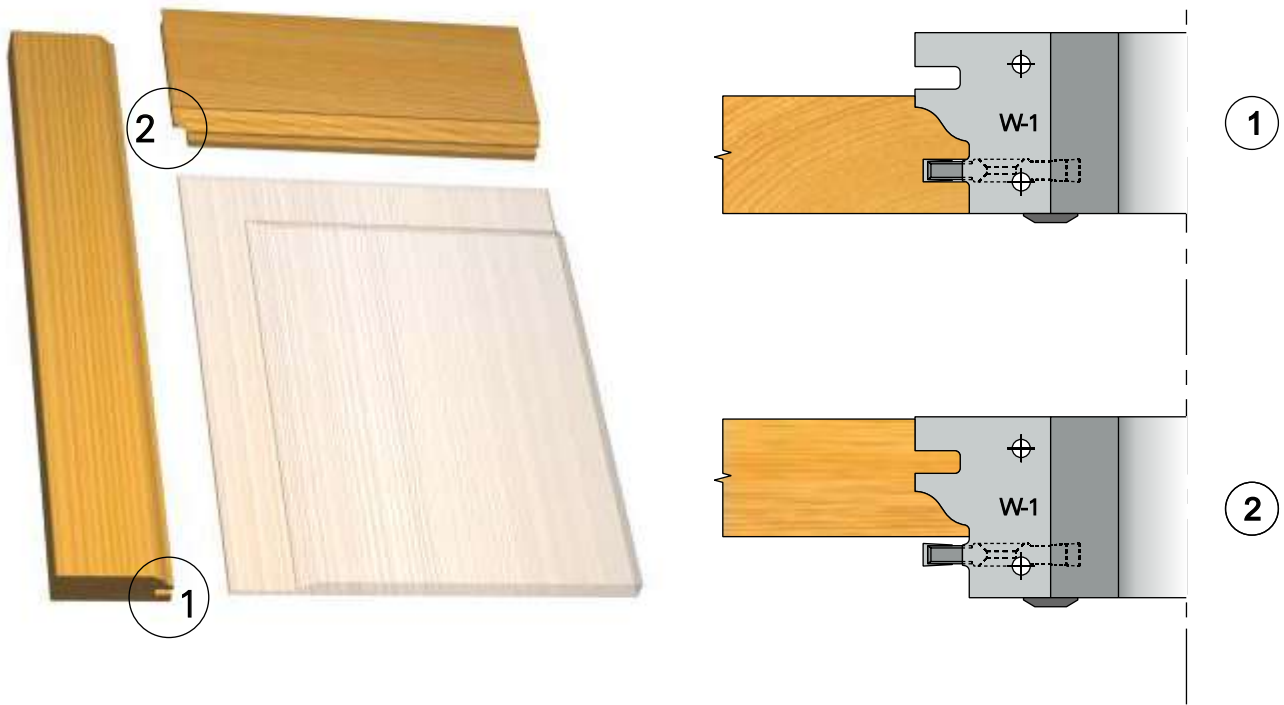

### Ricambi / Spare parts / Rechanges / Repuestos / Ersatzteile

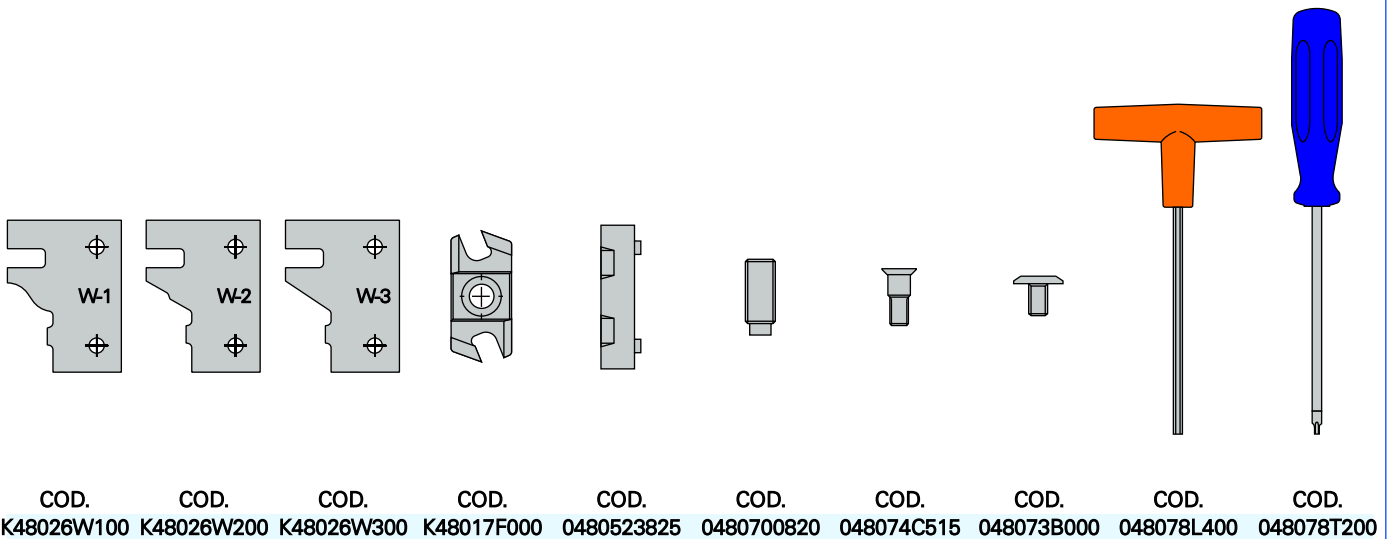

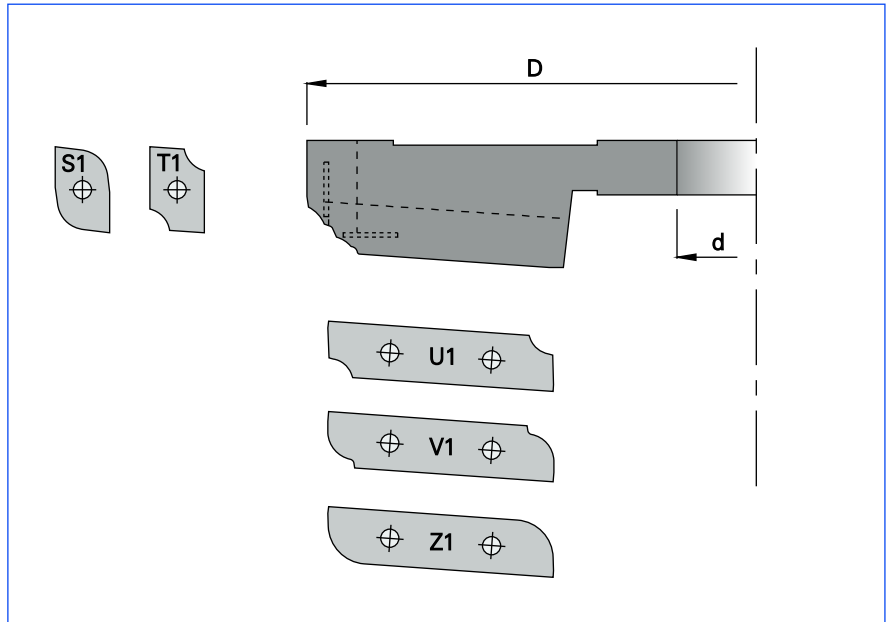

**HW**

**MAN**

n 3900 - 6600

**SET COMPLETO DI INSERTI S1 - T1 - U1 - V1 - Z1.**

D	d	Z	COD.
200	30	2+2	K427010030
200	31.75	2+2	K427010031
200	35	2+2	K427010035
200	40	2+2	K427010040
200	50	2+2	K427010050

**Ricambi / Spare parts / Rechanges / Repuestos / Ersatzteile**

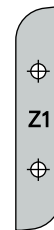
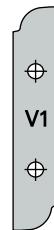
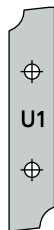

COD.  
K48027S100

COD.  
K48027T100

COD.  
K48027U100

COD.  
K48027V100

COD.  
K48027Z100

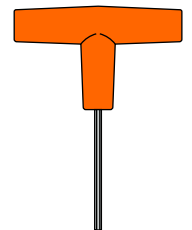
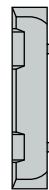

COD.  
048050AST1

COD.  
048050AUVZ

COD.  
048060C000

COD.  
0480700612

COD.  
048073A000

COD.  
0480783000



Multi - profile raised panel head, complete with profiled inserts S1 - T1 - U1 - V1 - Z1.



Cabezal multiperfiles para plafones, completo con cuchillas perfiladas S1 - T1 - U1 - V1 - Z1.



Porte - outil multiprofiles pour plate - bandes, complet avec plaquettes profilées S1 - T1 - U1 - V1 - Z1.



Multi - Profiler Abplatt - Messerkopf, komplett mit Profilmessern S1 - T1 - U1 - V1 - Z1.

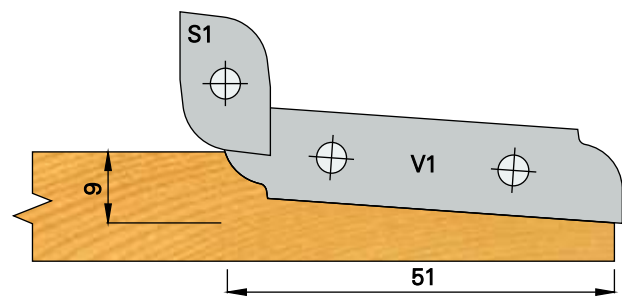
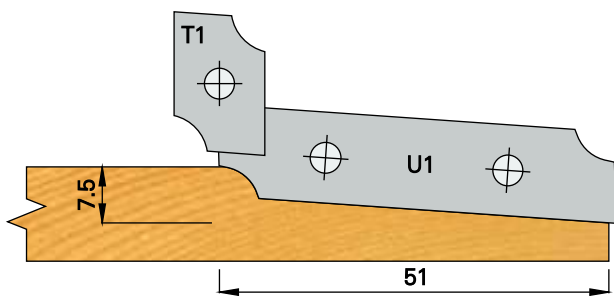
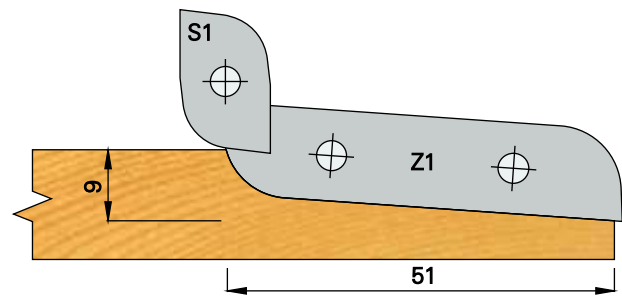
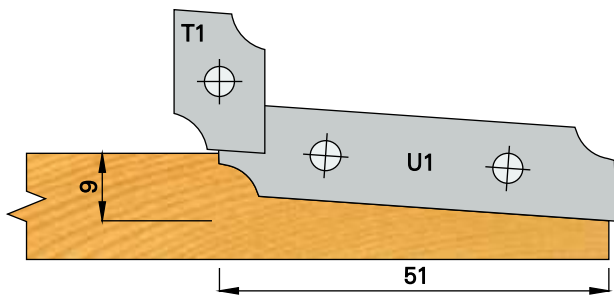
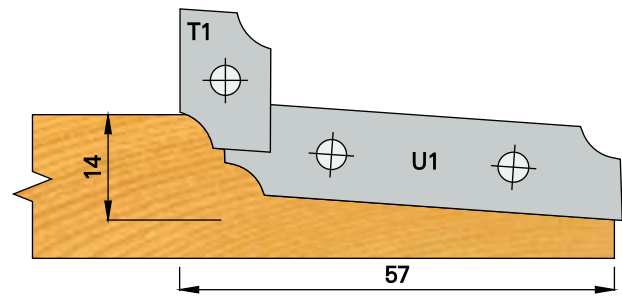
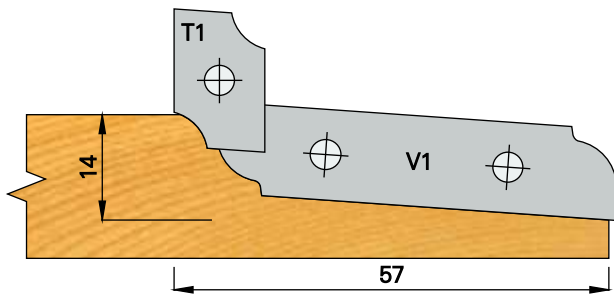
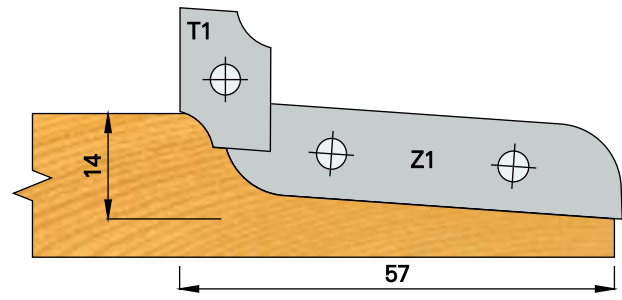
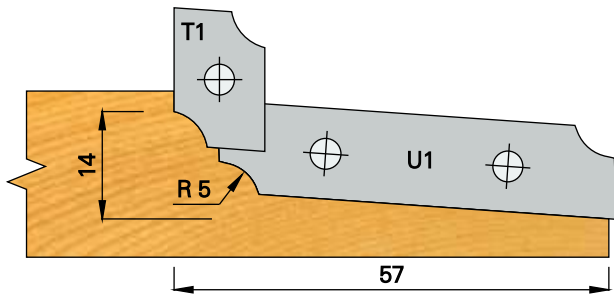
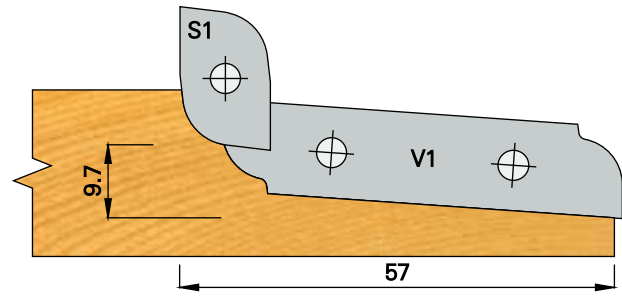
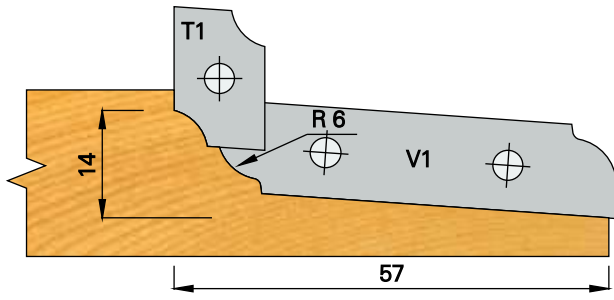
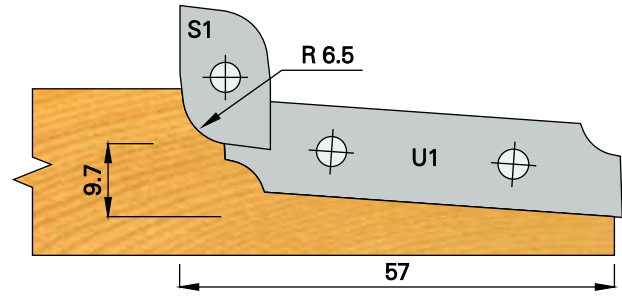
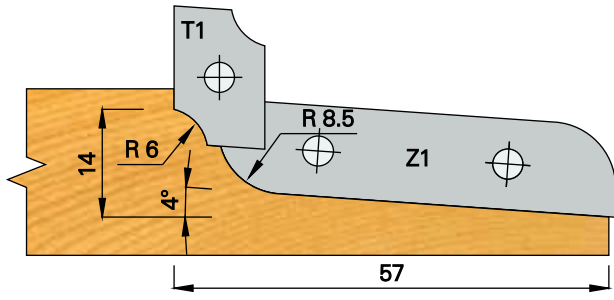



**HW**

**MAN**

n 3900 - 6600

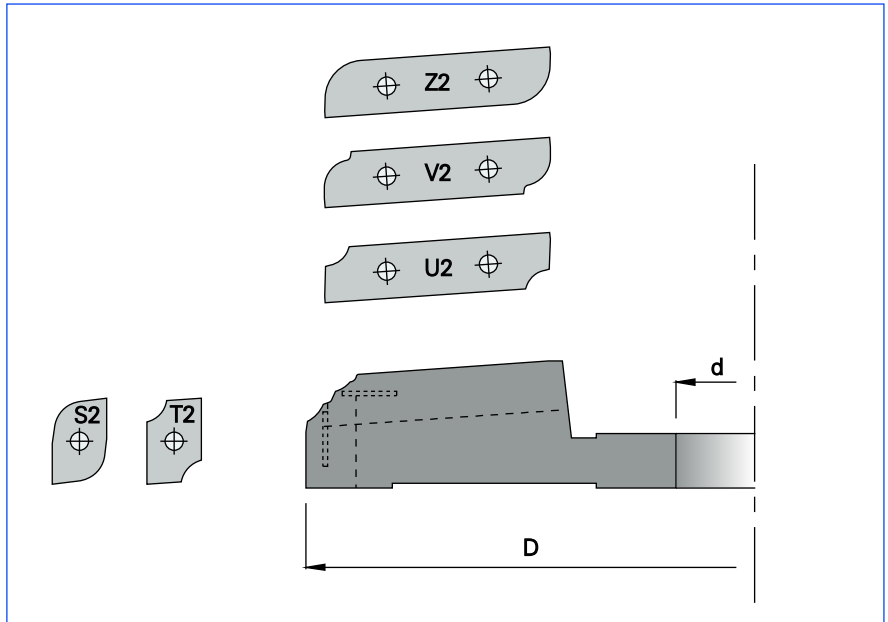

**SET COMPLETO DI INSERTI S2 - T2 - U2 - V2 - Z2.**

D	d	Z	COD.
200	30	2+2	K427020030
200	31.75	2+2	K427020031
200	35	2+2	K427020035
200	40	2+2	K427020040
200	50	2+2	K427020050

**Ricambi / Spare parts / Rechanges / Repuestos / Ersatzteile**



COD.  
K48027S200



COD.  
K48027T200

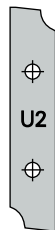

COD.  
K48027U200

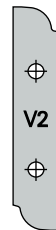

COD.  
K48027V200



COD.  
K48027Z200



COD.  
048050AST2

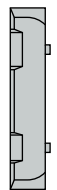

COD.  
048050AUVZ



COD.  
048060C000



COD.  
0480700612



COD.  
048073A000

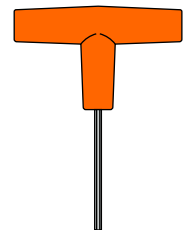

COD.  
0480783000



Multi - profile raised panel head, complete with profiled inserts S2 - T2 - U2 - V2 - Z2.



Cabezal multiperfiles para plafones, completo con cuchillas perfiladas S2 - T2 - U2 - V2 - Z2.



Porte - outil multiprofiles pour plate - bandes, complet avec plaquettes profilées S2 - T2 - U2 - V2 - Z2.



Multi - Profiler Abplatt - Messerkopf, komplett mit Profilmessern S2 - T2 - U2 - V2 - Z2.

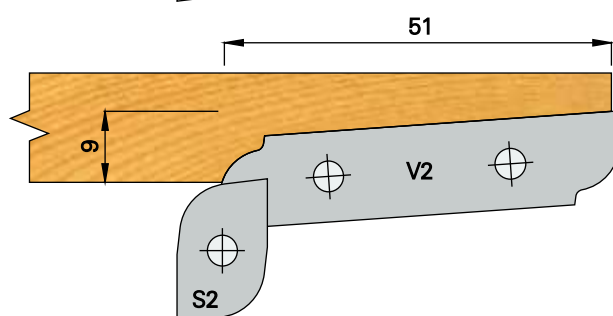
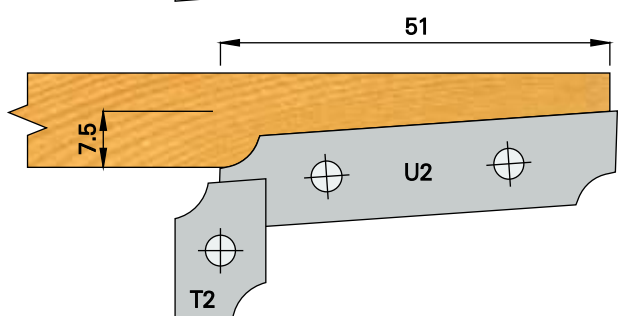
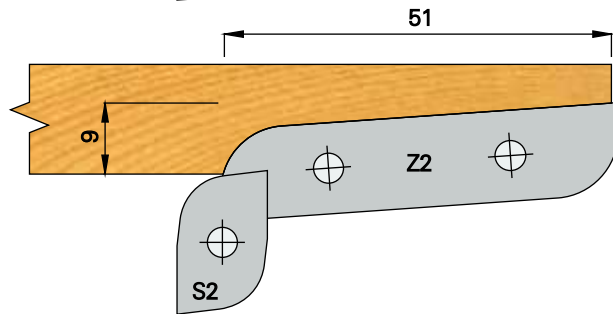
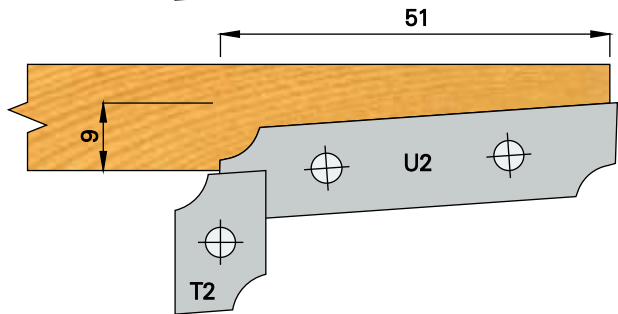
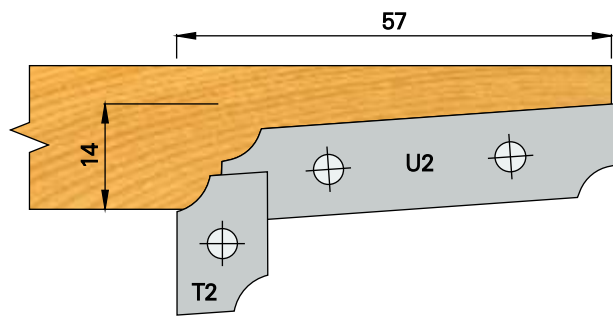
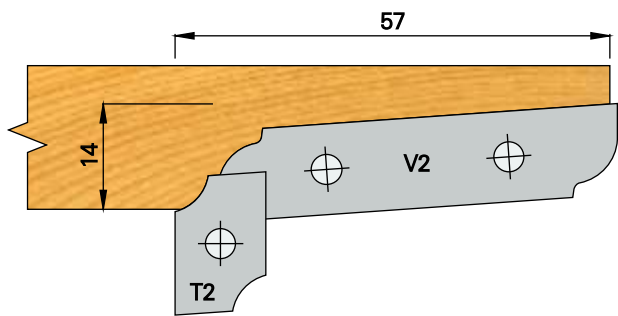
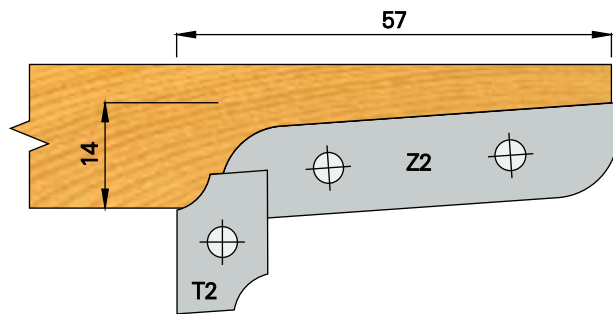
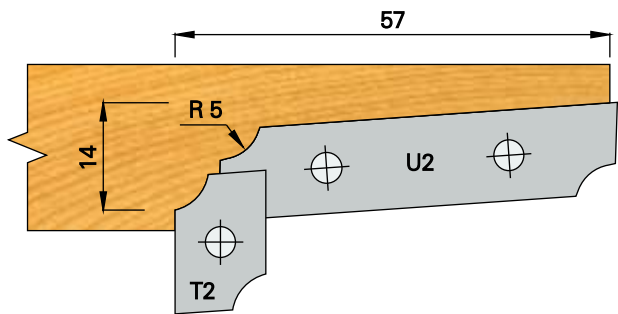
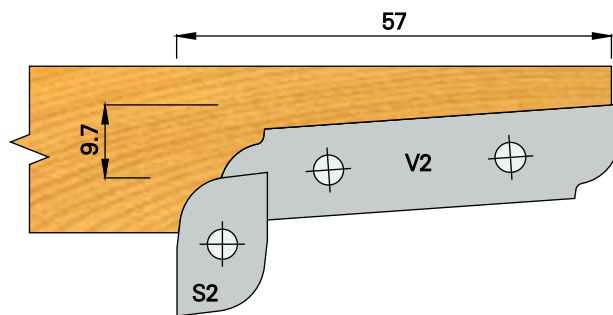
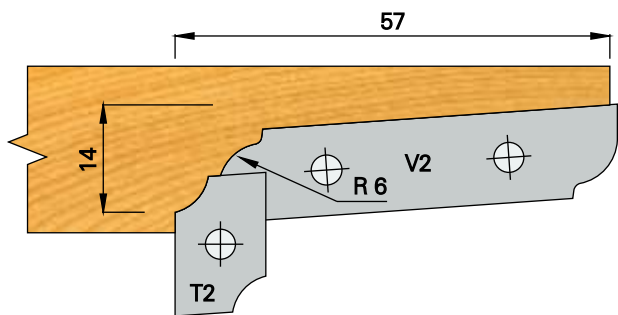
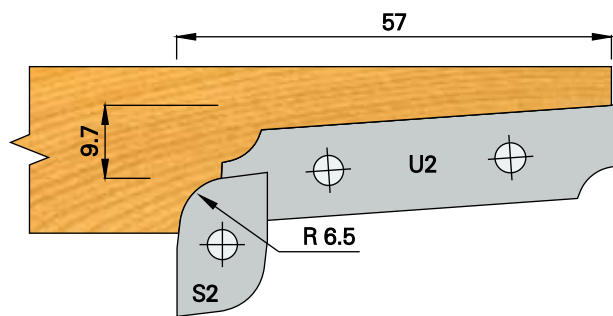
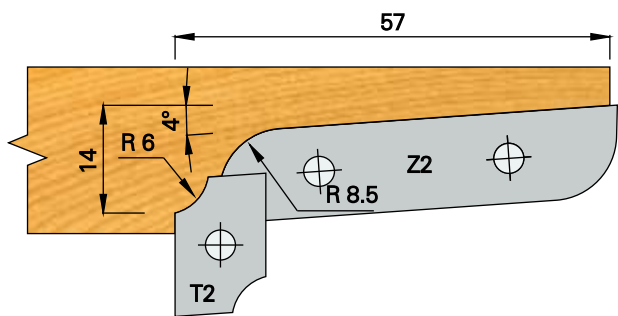



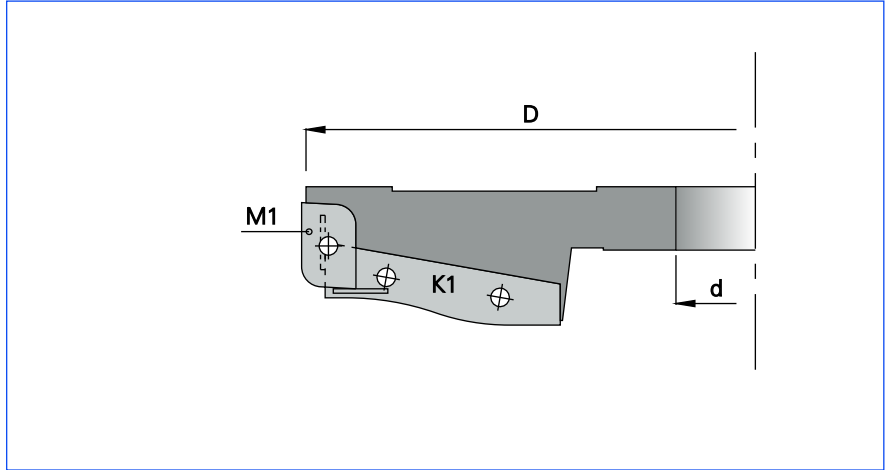

**HW**      **MAN**

n 3900 - 6600

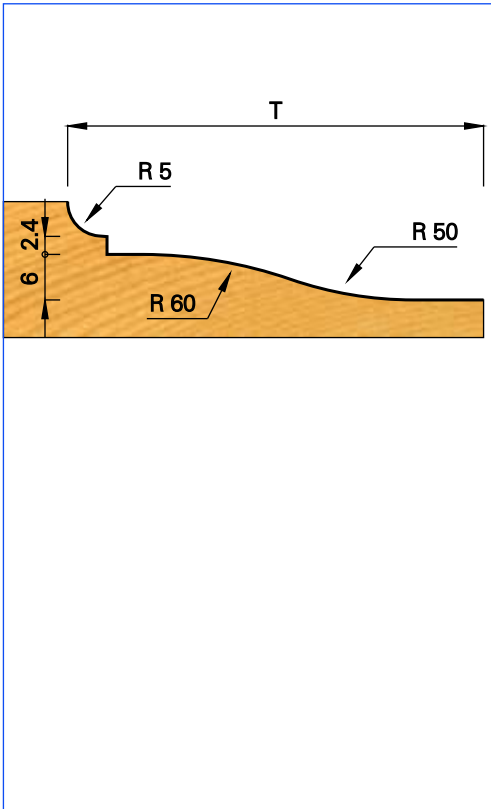

D	d	T	Z	COD.
200	30	56	2+2	K427030030
200	31.75	56	2+2	K427030031
200	35	56	2+2	K427030035
200	40	56	2+2	K427030040
200	50	56	2+2	K427030050

Ricambi / Spare parts / Rechanges / Repuestos / Ersatzteile

COD. K48027M100	COD. K48027K100	COD. 048050AST1	COD. K48050AK10	COD. 048060C000	COD. 0480700612	COD. 048073A000	COD. 0480783000

Raised panel cutter head.

Cabezal para plafones.

Porte - outil pour plate - bandes.

Abplatt - Messerkopf.

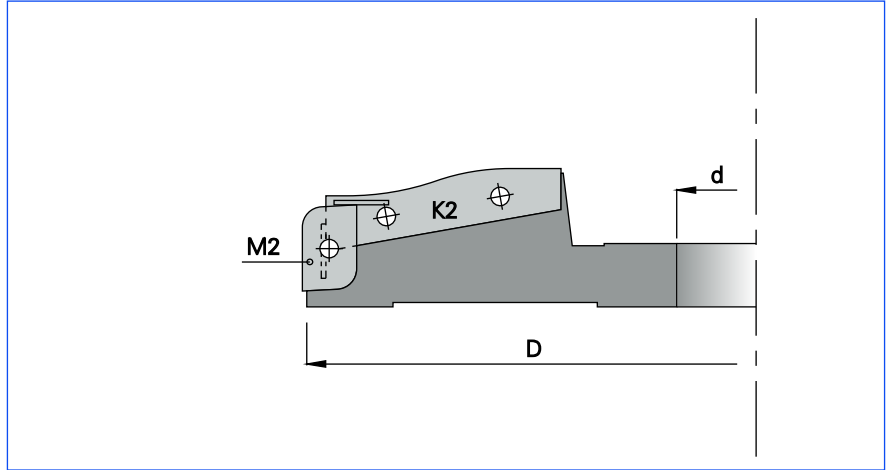

**HW**      **MAN**

n 3900 - 6600

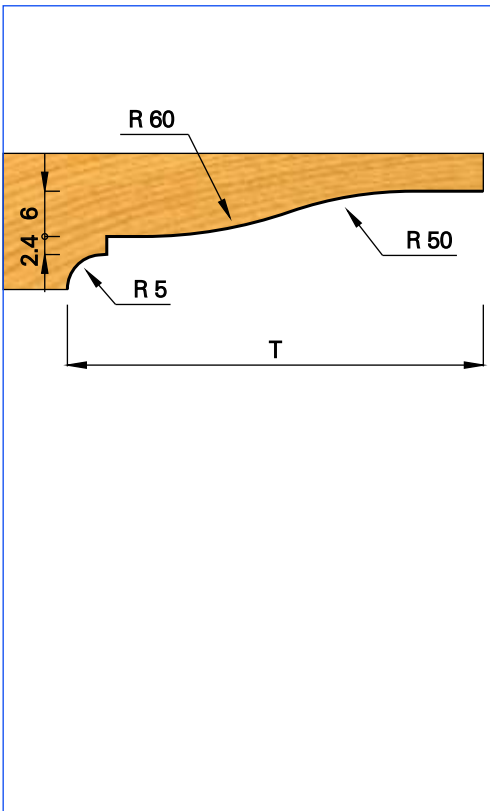

D	d	T	Z	COD.
200	30	56	2+2	K427040030
200	31.75	56	2+2	K427040031
200	35	56	2+2	K427040035
200	40	56	2+2	K427040040
200	50	56	2+2	K427040050

Ricambi / Spare parts / Rechanges / Repuestos / Ersatzteile

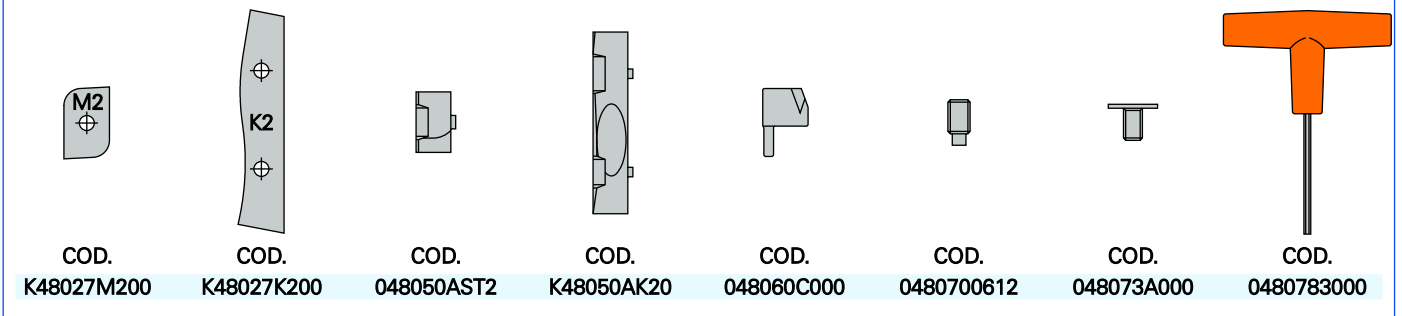

COD. K48027M200   
 COD. K48027K200   
 COD. 048050AST2   
 COD. K48050AK20   
 COD. 048060C000   
 COD. 0480700612   
 COD. 048073A000   
 COD. 0480783000

	Raised panel cutter head.		Cabezal para plafones.
	Porte - outil pour plate - bandes.		Abplatt - Messerkopf.



**HW**

**MAN**

n 3900 - 6600

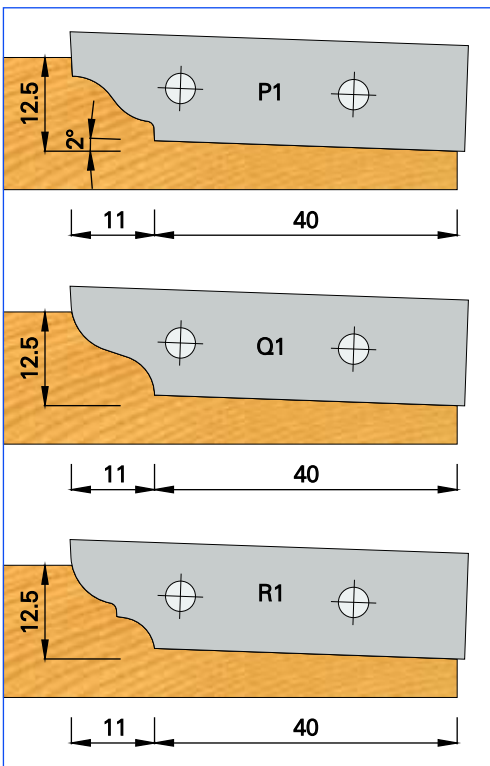
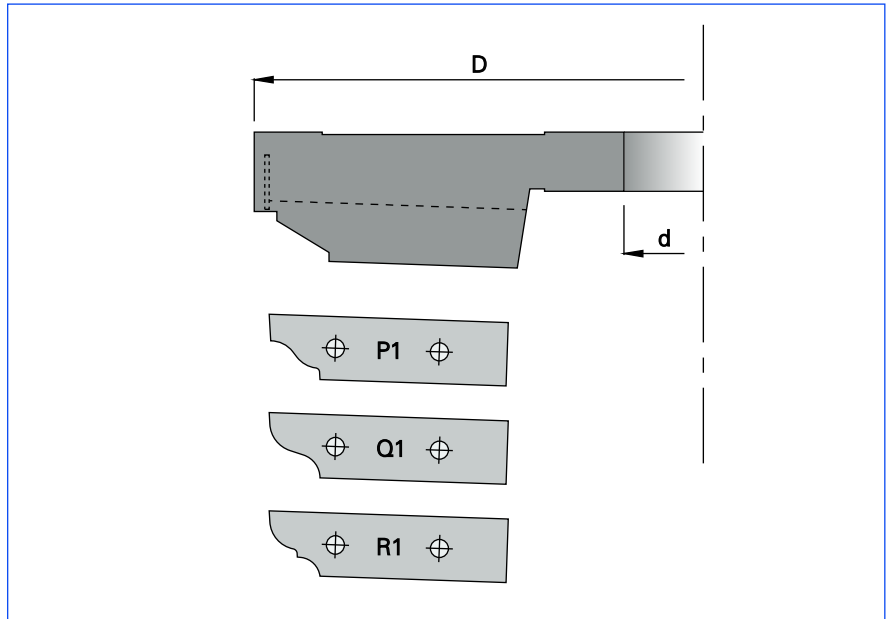

### SET COMPLETO DI INSERTI P1 - Q1 - R1.

D	d	Z	COD.
198	30	2	K427050030
198	31.75	2	K427050031
198	35	2	K427050035
198	40	2	K427050040
198	50	2	K427050050

### Ricambi / Spare parts / Rechanges / Repuestos / Ersatzteile

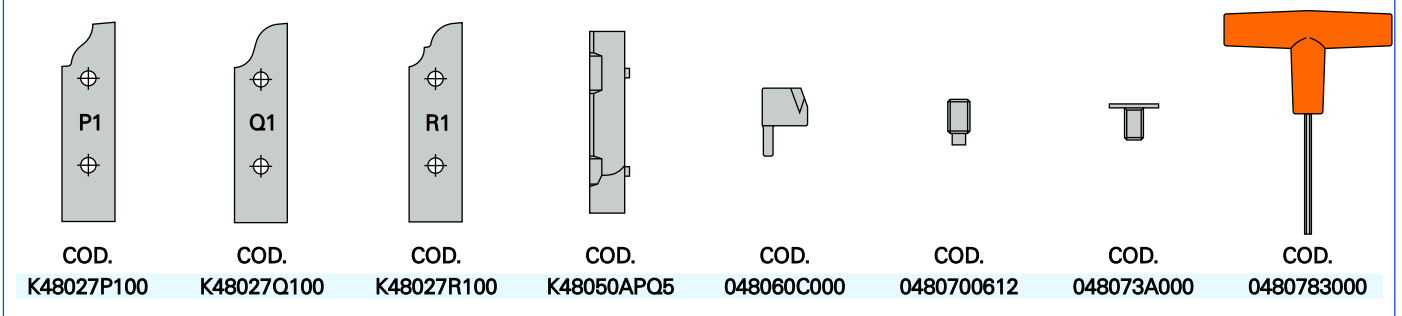

Multi - profile raised panel head, complete with profiled inserts P1 - Q1 - R1.



Cabezal multiperfiles para plafones, completo con cuchillas perfiladas P1 - Q1 - R1.



Porte - outil multiprofiles pour plate - bandes, complet avec plaquettes profilées P1 - Q1 - R1.



Multi - Profiler Abplatt - Messerkopf, komplett mit Profilmessern P1 - Q1 - R1.



**HW**

**MAN**

n 3900 - 6600

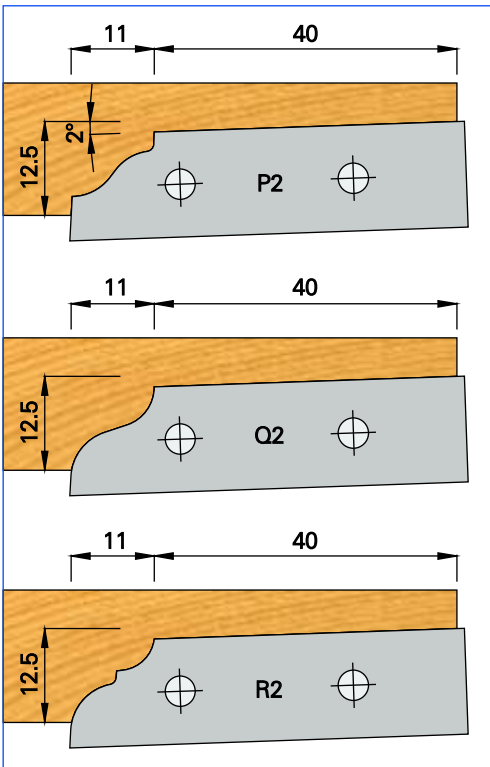
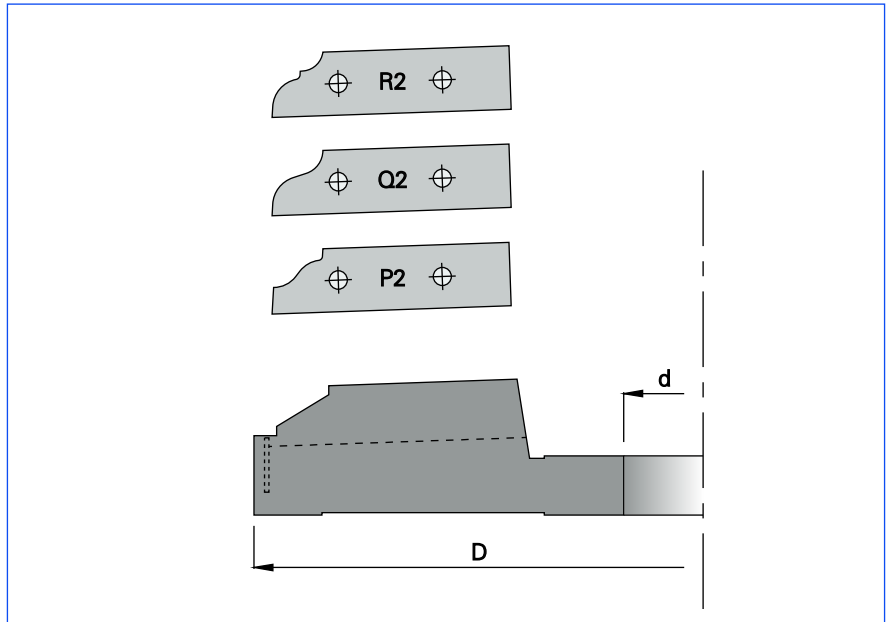

### SET COMPLETO DI INSERTI P2 - Q2 - R2.

D	d	Z	COD.
198	30	2	K427060030
198	31.75	2	K427060031
198	35	2	K427060035
198	40	2	K427060040
198	50	2	K427060050

### Ricambi / Spare parts / Rechanges / Repuestos / Ersatzteile

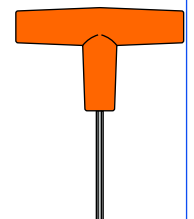
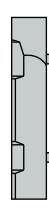
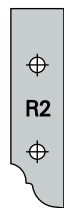
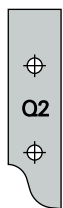
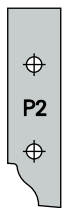

COD.  
K48027P200

COD.  
K48027Q200

COD.  
K48027R200

COD.  
K48050APQ6

COD.  
048060C000

COD.  
0480700612

COD.  
048073A000

COD.  
0480783000

Multi - profile raised panel head, complete with profiled inserts P2 - Q2 - R2.

Cabezal multiperfiles para plafones, completo con cuchillas perfiladas P2 - Q2 - R2.

Porte - outil multiprofiles pour plate - bandes, complet avec plaquettes profilées P2 - Q2 - R2.

Multi - Profiler Abplatt - Messerkopf, komplett mit Profilmessern P2 - Q2 - R2.



**HW**

**MAN**

n 3900 - 6000

– corpo in lega leggera

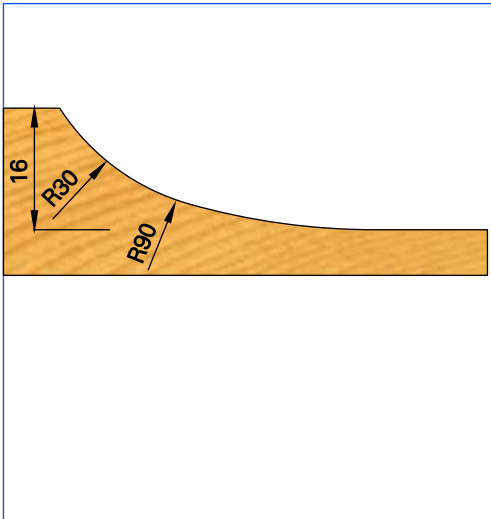
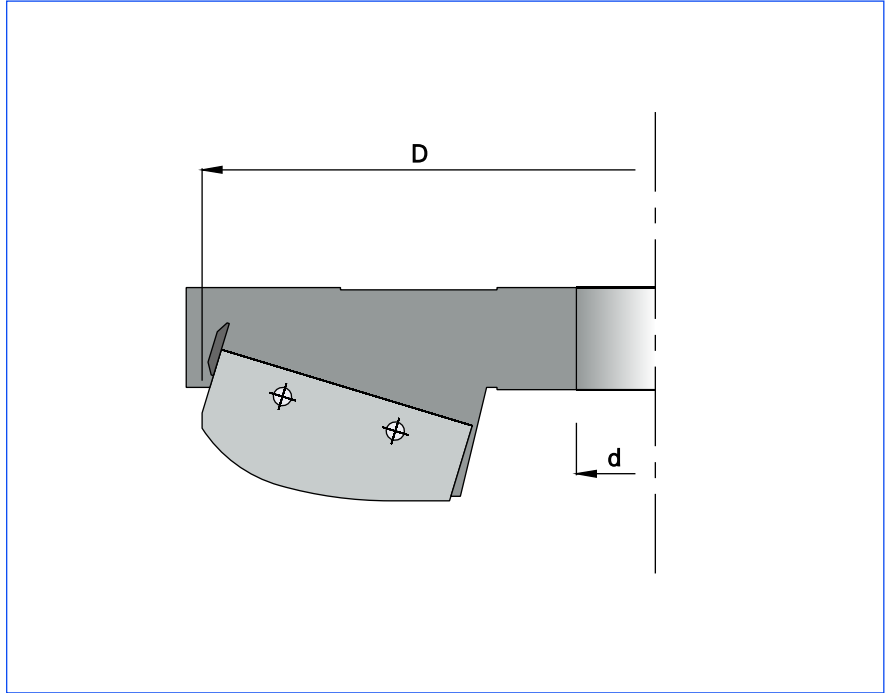

D	d	Z	COD.
200	30	3	K427070030
200	31.75	3	K427070031
200	35	3	K427070035
200	40	3	K427070040
200	50	3	K427070050

### Ricambi / Spare parts / Rechanges / Repuestos / Ersatzteile

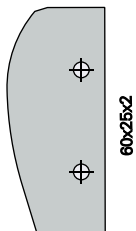

COD.  
K48027A700

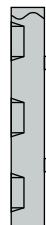

COD.  
048052582M



COD.  
0480700820



COD.  
048073B000

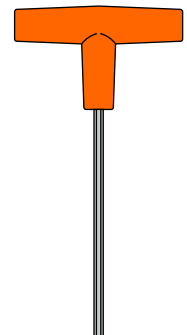

COD.  
048078L400



Raised panel cutter head.  
Light alloy tool body.



Cabezal para plafones.  
Cuerpo de aleacion leggera.



Porte - outil pour plate - bandes.  
Corps en alliage léger.



Abplatt - Messerkopf.  
Tragkörper aus Leichtmetall.



**HW**

**MAN**

n 4400 - 7600

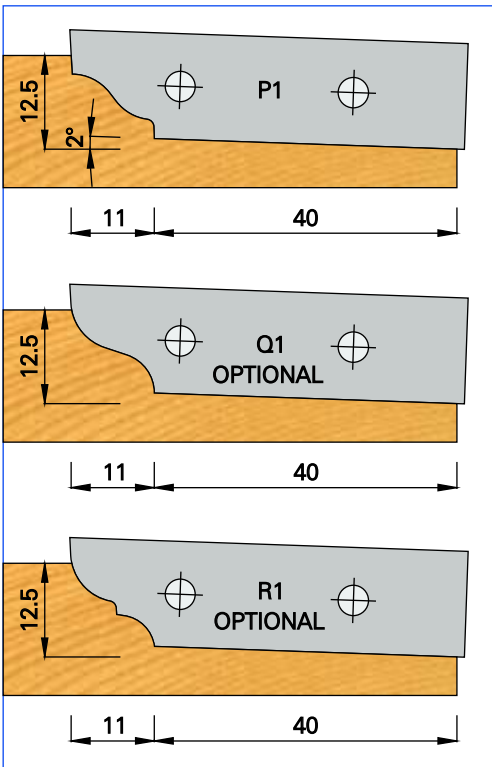
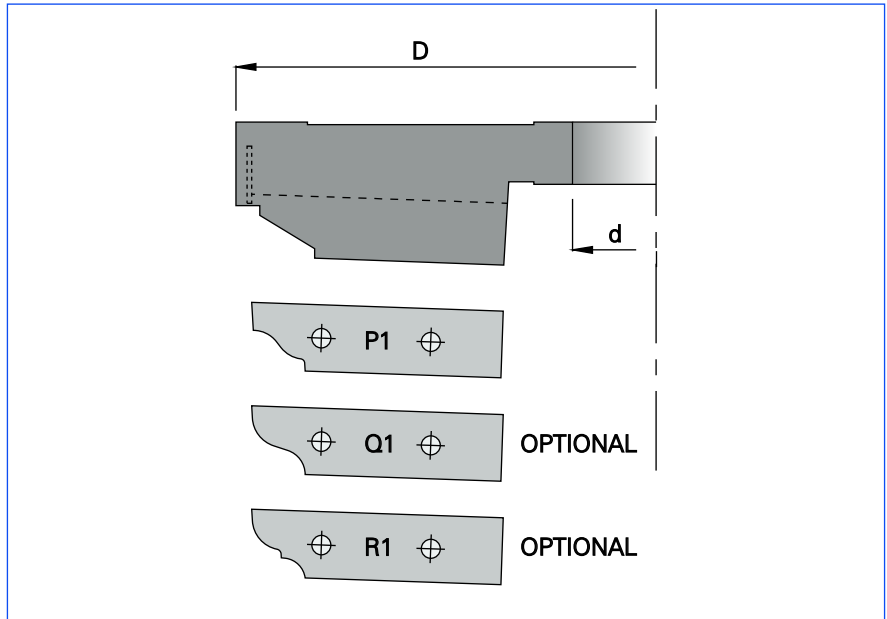

### SET COMPLETO DI INSERTI P1

D	d	Z	COD.
175	30	2	K427090030
175	31.75	2	K427090031
175	35	2	K427090035

### Ricambi / Spare parts / Rechanges / Repuestos / Ersatzteile

COD. K48027P100	COD. K48027Q100	COD. K48027R100	COD. K48050APQ5	COD. 048060C000	COD. 0480700612	COD. 048073A000	COD. 0480783000

Multi - profile raised panel head, complete with profiled inserts P1.

Cabezal multiperfiles para plafones, completo con cuchillas perfiladas P1.

Porte - outil multiprofiles pour plate - bandes, complet avec plaquettes profilées P1.

Multi - Profiler Abplatt - Messerkopf, komplett mit Profilmessern P1.



SP

MEC

n max 8000

Il set è composto da:

- 1 Testa portacoltelli Art 393-T Z = 2 ;
- 7 Coppie di coltelli B = 48 a = 5.5 ;  
profilo 141 - 142 - 146 - 147 - 152 - 153 - 162 ;
- 1 Pietra ad olio per l' affilatura ;
- 1 Contenitore in materiale plastico.



ART

d

COD. SET

393 - C  
393 - C30  
31.750393C08230  
0393C08231

Set multi - profile 393 - C.

The set includes :

- 1 Cutter head Art 393-T Z = 2 ;
- 7 Pairs of knives B = 48 a = 5.5 ;  
ref. 141 - 142 - 146 - 147 - 152 - 153 -162 ;
- 1 Sharpening oil stone ;
- 1 Plastic case.



Estuche multiperfiles 393 - C.

El juego comprende :

- 1 Cabezal Art 393-T Z = 2 ;
- 7 Pares de cuchillas B = 48 a = 5.5 ;  
ref. 141 - 142 - 146 - 147 - 152 - 153 -162 ;
- 1 Afiladora ;
- 1 Estuche de plàstica.



Coffret multiprofiles 393 - C.

Le jeu comprend :

- 1 Porte - outils Art 393-T Z = 2 ;
- 7 Paires de couteaux B = 48 a = 5.5 ;  
réf. 141 - 142 - 146 - 147 - 152 - 153 -162 ;
- 1 Pierre à l' huile pour l' affûtage ;
- 1 Coffret en plastique.



Multi - Profil Satz 393 - C.

Der Satz besteht aus :

- 1 Messerkopf Art 393-T Z = 2 ;
- 7 Messerpaaren B = 48 a = 5.5 ;  
Profil 141 - 142 - 146 - 147 - 152 - 153 -162 ;
- 1 Schleifölstein ;
- 1 Plastiketu.



d	D2	D MAX
30	82	120
31.75	82	120

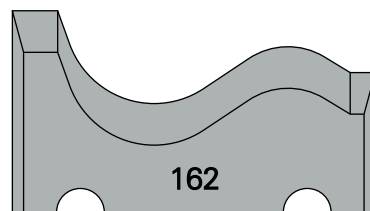
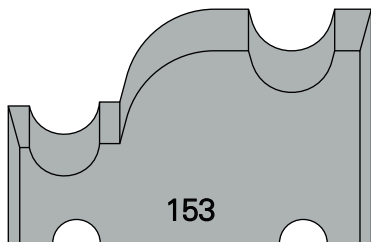
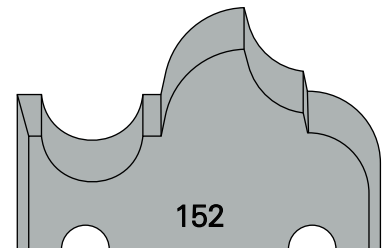
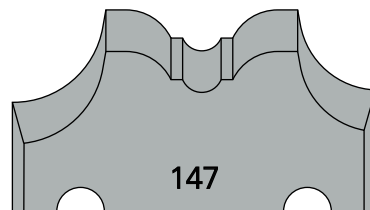
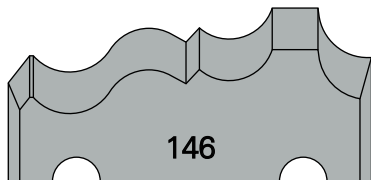
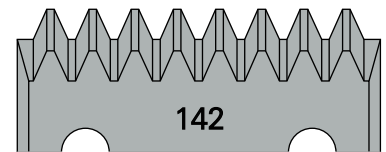
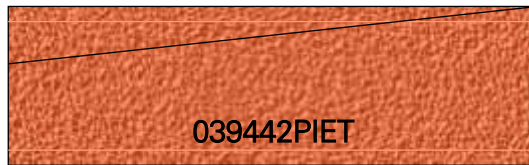
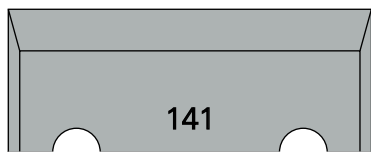
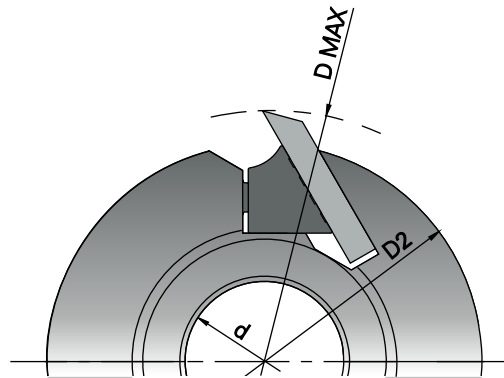



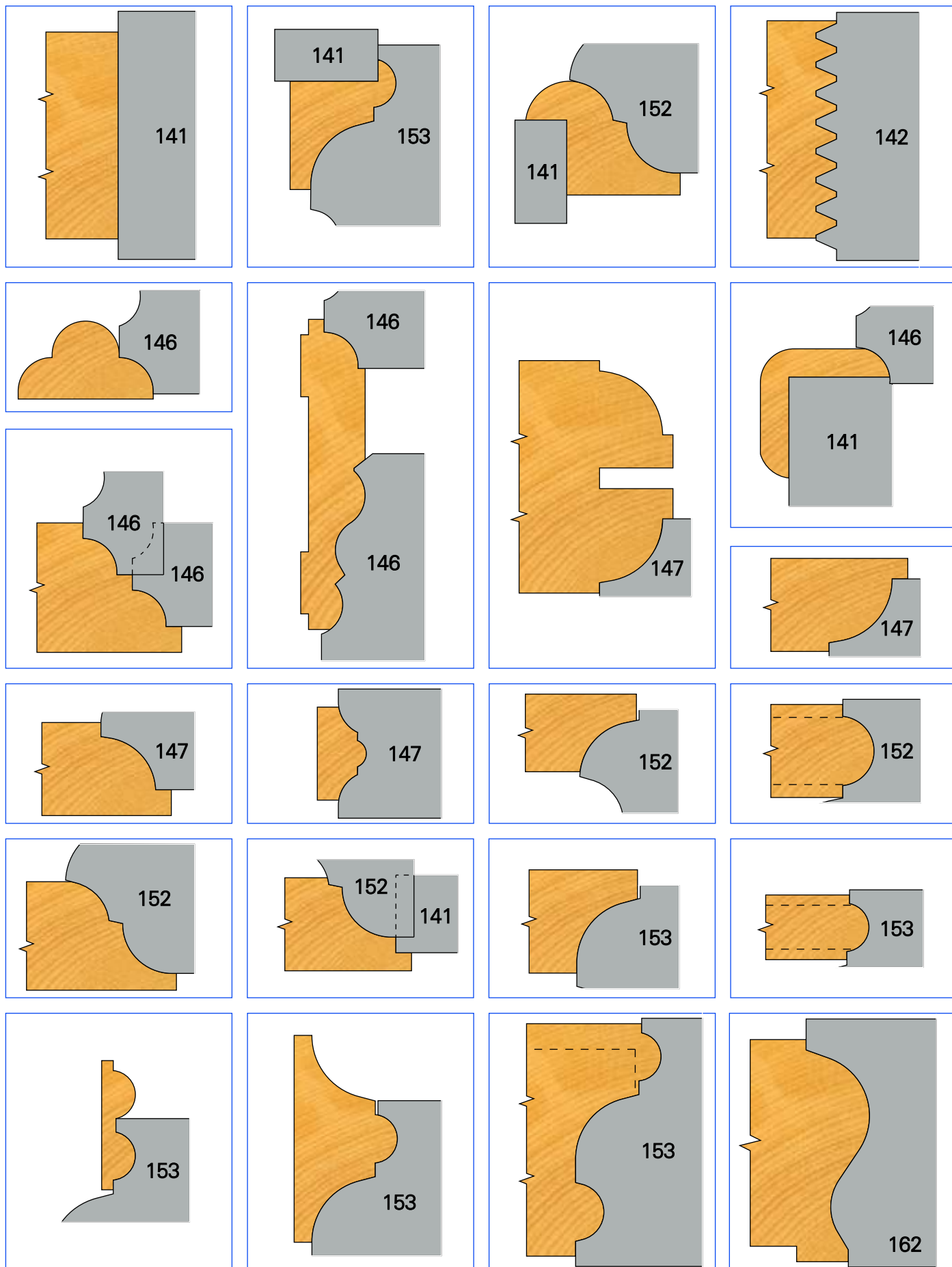

Examples of workable profiles.



Ejemplos de perfiles realizables.



Exemples de profils réalisables.



Durchführbaren Profilbeispiele.

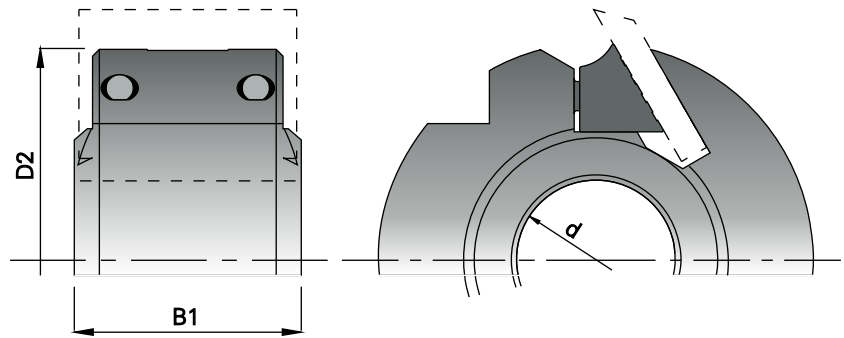

**MEC**

n max 8000

D2	B1	d	Z	COD.
82	50	30	2	0393T08230
82	50	31.75	2	0393T08231

Ricambi / Spare parts / Rechanges / Repuestos / Ersatzteile

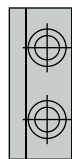

COD.

048053393T



COD.

0480700820

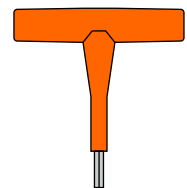

COD.

0480784000

 Cutter head.

 Cabezal.

 Porte - outils.

 Messerkopf.



SP

MEC

D2 = 97 - n max 8000  
D2 = 117 - n max 7000

**394 - C**

Il set è composto da:

- 1 Testa portacoltelli Art 394-T Z = 2 ;
- 14 Coppie di coltelli B = 48 a = 5.5 ;  
profilo 141 - 142 - 143 - 144 - 146 - 147 -  
148 - 149 - 150 - 151 - 152 - 153 - 154 -  
155 ;
- 1 Pietra ad olio per l' affilatura ;
- 1 Contenitore in materiale plastico.

**394 - R**

Il set è composto da:

- 13 Coppie di coltelli B = 48 a = 5.5 ;  
profilo 142 - 143 - 144 - 146 - 147 - 148 -  
149 - 150 - 151 - 152 - 153 - 154 - 155 ;
- 1 Pietra ad olio per l' affilatura ;
- 1 Contenitore in materiale plastico.



ART

d

COD. SET

394 - C	30	0394C09730
394 - C	31,75	0394C09731
394 - C	35	0394C09735
394 - C	40	0394C11740
394 - C	50	0394C11750
394 - R		0394R00000

**Set multi - profile 394 - C.**

The set includes :

- 1 Cutter head Art 394-T Z = 2 ;
- 14 Pairs of knives B = 48 a = 5.5 ;  
ref. 141 - 142 - 143 - 144 - 146 - 147 -148 - 149 - 150 - 151 -  
152 - 153 - 154 - 155 ;
- 1 Sharpening oil stone ;
- 1 Plastic case.

**Set multi - profile 394 - R.**

The set includes :

- 13 Pairs of knives B = 48 a = 5.5 ;  
ref. 142 - 143 - 144 - 146 - 147 -148 - 149 - 150 - 151- 152 -  
153 - 154 - 155 ;
- 1 Sharpening oil stone ;
- 1 Plastic case.

**Estuche multiperfiles 394 - C.**

El juego comprende :

- 1 Cabezal Art 394-T Z = 2 ;
- 14 Pares de cuchillas B = 48 a = 5.5 ;  
ref. 141 - 142 - 143 - 144 - 146 - 147 -148 - 149 - 150 - 151 -  
152 - 153 - 154 - 155 ;
- 1 Afiladora ;
- 1 Estuche de plàstica.

**Estuche multiperfiles 394 - R.**

El juego comprende :

- 13 Pares de cuchillas B = 48 a = 5.5 ;  
ref. 142 - 143 - 144 - 146 - 147 -148 - 149 - 150 - 151- 152 -  
153 - 154 - 155 ;
- 1 Afiladora ;
- 1 Estuche de plàstica.

**Coffret multiprofiles 394 - C.**

Le jeu comprend :

- 1 Porte - outils Art 394-T Z = 2 ;
- 14 Paires de couteaux B = 48 a = 5.5 ;  
réf. 141 - 142 - 143 - 144 - 146 - 147 -148 - 149 - 150 - 151 -  
152 - 153 - 154 - 155 ;
- 1 Pierre à l' huile pour l' affûtage ;
- 1 Coffret en plastique.

**Coffret multiprofiles 394 - R.**

Le jeu comprend :

- 13 Paires de couteaux B = 48 a = 5.5 ;  
réf. 142 - 143 - 144 - 146 - 147 -148 - 149 - 150 - 151- 152 -  
153 - 154 - 155 ;
- 1 Pierre à l' huile pour l' affûtage ;
- 1 Coffret en plastique.

**Multi - Profil Satz 394 - C.**

Der Satz besteht aus :

- 1 Messerkopf Art 394-T Z = 2 ;
- 14 Messerpaaren B = 48 a = 5.5 ;  
Profil 141 - 142 - 143 - 144 - 146 - 147 -148 - 149 - 150 - 151 -  
152 - 153 - 154 - 155 ;
- 1 Schleifölstein ;
- 1 Plastiksetui.

**Multi - Profil Satz 394 - R.**

Der Satz besteht aus :

- 13 Messerpaaren B = 48 a = 5.5 ;  
Profil 142 - 143 - 144 - 146 - 147 -148 - 149 - 150 - 151- 152 -  
153 - 154 - 155 ;
- 1 Scheifölstein ;
- 1 Plastiksetui.



d	D2	D MAX
30	97	146
31.75	97	146
35	97	146
40	117	167
50	117	167

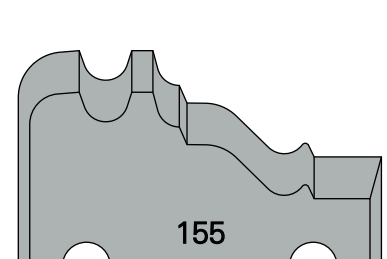
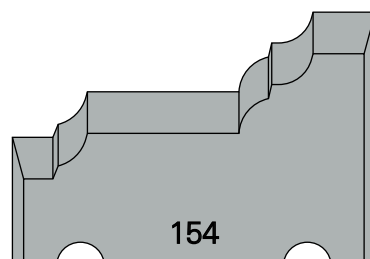
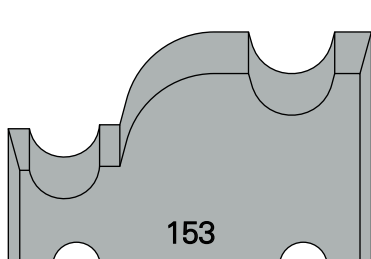
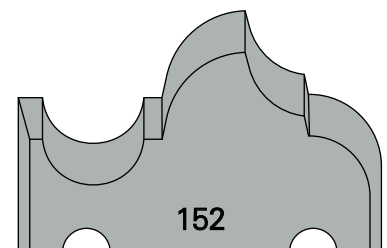
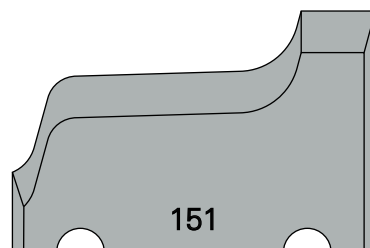
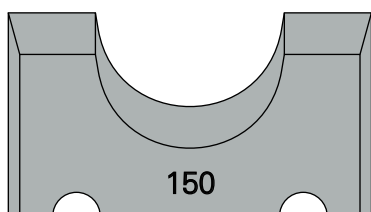
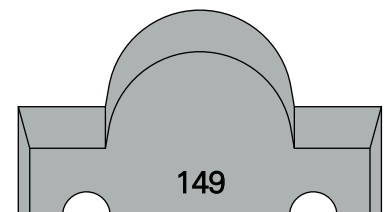
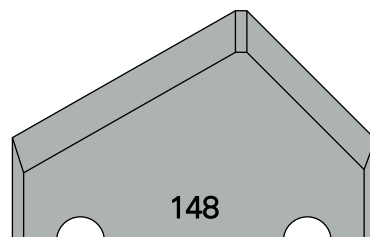
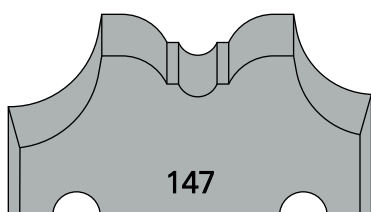
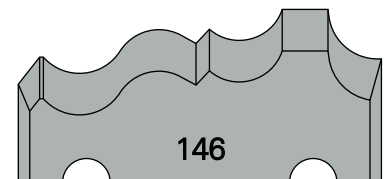
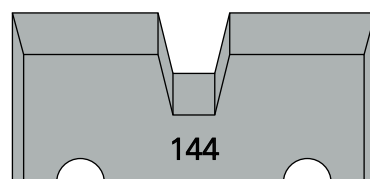
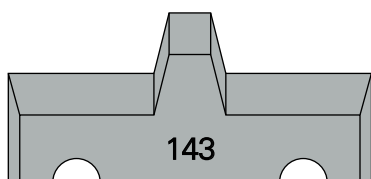
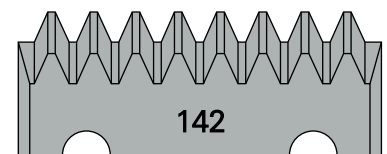
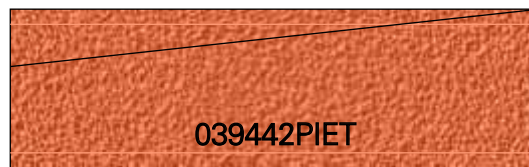
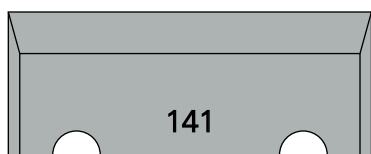
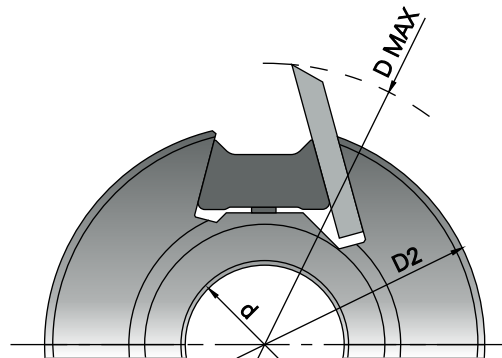



**SP**

**MAN**

D2 = 97 - n 6000 - 8000  
D2 = 117 - n 5900 - 7000

### K 394 - C

Il set è composto da:

- 1 Testa portacoltelli Art K 394-T Z = 2 ;
- 14 Coppie di coltelli B = 48 a = 5.5 ;  
profilo 141 - 142 - 143 - 144 - 146 - 147 -  
148 - 149 - 150 - 151 - 152 - 153 - 154 -  
155 ;
- 14 Coppie di relativi limitatori ;
- 1 Pietra ad olio per l' affilatura ;
- 1 Contenitore in materiale plastico.

### K 394 - R

Il set è composto da:

- 13 Coppie di coltelli B = 48 a = 5.5 ;  
profilo 142 - 143 - 144 - 146 - 147 - 148 -  
149 - 150 - 151 - 152 - 153 - 154 - 155 ;
- 13 Coppie di relativi limitatori ;
- 1 Pietra ad olio per l' affilatura ;
- 1 Contenitore in materiale plastico.



ART	d	COD. SET
K394 - C	30	K394C09730
K394 - C	31.75	K394C09731
K394 - C	35	K394C09735
K394 - C	40	K394C11740
K394 - C	50	K394C11750
K394 - R		K394R00000



#### Set multi - profile K 394 - C.

The set includes :

- 1 Cutter head Art K 394-T Z = 2 ;
- 14 Pairs of knives B = 48 a = 5.5 ;  
ref. 141 - 142 - 143 - 144 - 146 - 147 -148 - 149 - 150 - 151 -  
152 - 153 - 154 - 155 ;
- 14 Pairs of chip - limitors ;
- 1 Sharpening oil stone ;
- 1 Plastic case.

#### Set multi - profile K 394 - R.

The set includes :

- 13 Pairs of knives B = 48 a = 5.5 ;  
ref. 142 - 143 - 144 - 146 - 147 -148 - 149 - 150 - 151 - 152 -  
153 - 154 - 155 ;
- 13 Pairs of chip - limitors ;
- 1 Sharpening oil stone ;
- 1 Plastic case.



#### Estuche multiperfiles K 394 - C.

El juego comprende :

- 1 Cabezal Art K 394-T Z = 2 ;
- 14 Pares de cuchillas B = 48 a = 5.5 ;  
ref. 141 - 142 - 143 - 144 - 146 - 147 -148 - 149 - 150 - 151 -  
152 - 153 - 154 - 155 ;
- 14 Pares de limitadores ;
- 1 Afiladora ;
- 1 Estuche de plàstica.

#### Estuche multiperfiles K 394 - R.

El juego comprende :

- 13 Pares de cuchillas B = 48 a = 5.5 ;  
ref. 142 - 143 - 144 - 146 - 147 -148 - 149 - 150 - 151 - 152 -  
153 - 154 - 155 ;
- 13 Pares de limitadores ;
- 1 Afiladora ;
- 1 Estuche de plàstica.



#### Coffret multiprofiles K 394 - C.

Le jeu comprend :

- 1 Porte - outils Art K 394-T Z = 2 ;
- 14 Paires de couteaux B = 48 a = 5.5 ;  
réf. 141 - 142 - 143 - 144 - 146 - 147 -148 - 149 - 150 - 151 -  
152 - 153 - 154 - 155 ;
- 14 Paires de limiteurs ;
- 1 Pierre à l' huile pour l' affûtage ;
- 1 Coffret en plastique.

#### Coffret multiprofiles K 394 - R.

Le jeu comprend :

- 13 Paires de couteaux B = 48 a = 5.5 ;  
réf. 142 - 143 - 144 - 146 - 147 -148 - 149 - 150 - 151 - 152 -  
153 - 154 - 155 ;
- 13 Paires de limiteurs ;
- 1 Pierre à l' huile pour l' affûtage ;
- 1 Coffret en plastique.



#### Multi - Profil Satz K 394 - C.

Der Satz besteht aus :

- 1 Messerkopf Art K 394-T Z = 2 ;
- 14 Messerpaaren B = 48 a = 5.5 ;  
Profil 141 - 142 - 143 - 144 - 146 - 147 -148 - 149 - 150 - 151 -  
152 - 153 - 154 - 155 ;
- 14 Abweiserpaaren ;
- 1 Schleifölstein ;
- 1 Plastiketui.

#### Multi - Profil Satz K 394 - R.

Der Satz besteht aus :

- 13 Messerpaaren B = 48 a = 5.5 ;  
Profil 142 - 143 - 144 - 146 - 147 -148 - 149 - 150 - 151 - 152 -  
153 - 154 - 155 ;
- 13 Abweiserpaaren ;
- 1 Scheifhölstein ;
- 1 Plastiketui.



d	D2	D MAX
30	97	146
31.75	97	146
35	97	146
40	117	167
50	117	167

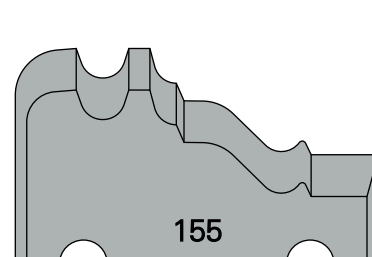
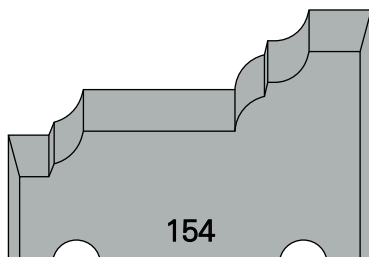
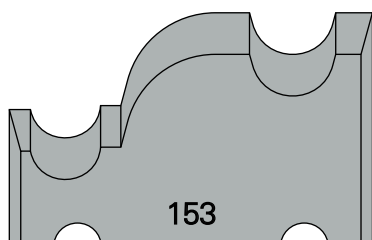
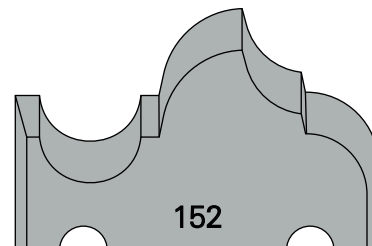
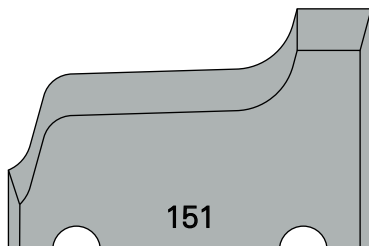
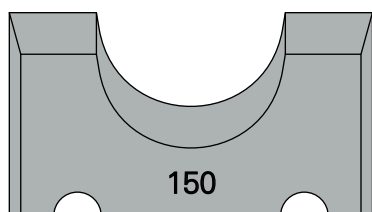
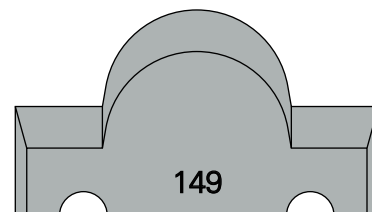
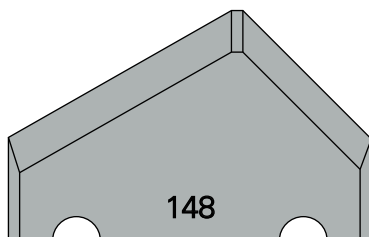
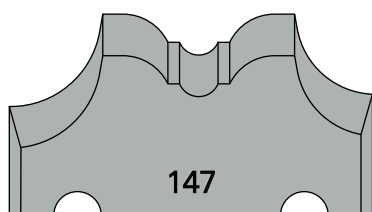
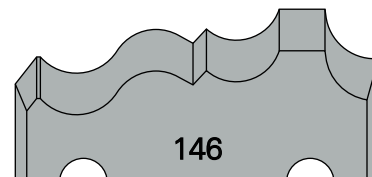
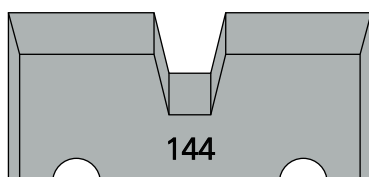
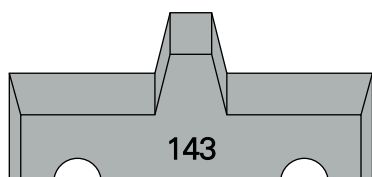
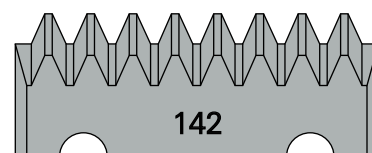
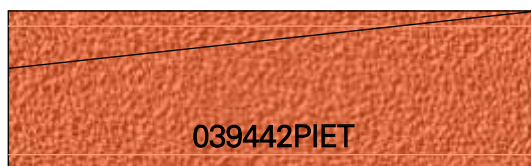
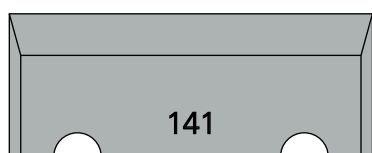
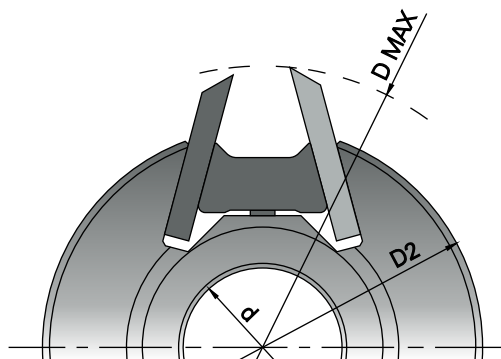



SP

MEC

D2 = 97 - n max 8000  
D2 = 117 - n max 7000

**396 - C**

Il set è composto da:

- 1 Testa portacoltelli Art 394-T Z = 2 ;
- 14 Coppie di coltelli B = 48 a = 5.5 ;  
profilo 141 - 156A - 156B - 156C - 157 -  
158A - 158B - 158C - 159A - 159B - 159C -  
160A - 160B - 160C ;
- 1 Pietra ad olio per l' affilatura ;
- 1 Contenitore in materiale plastico.

**396 - R**

Il set è composto da:

- 13 Coppie di coltelli B = 48 a = 5.5 ;  
profilo 156A - 156B - 156C - 157 - 158A -  
158B - 158C - 159A - 159B - 159C - 160A -  
160B - 160C ;
- 1 Pietra ad olio per l' affilatura ;
- 1 Contenitore in materiale plastico.



ART

d

COD. SET

396 - C	30	0396C09730
396 - C	31.75	0396C09731
396 - C	35	0396C09735
396 - C	40	0396C11740
396 - C	50	0396C11750
396 - R		0396R00000

**Set multi - profile 396 - C.**

The set includes :

- 1 Cutter head Art 394-T Z = 2 ;
- 14 Pairs of knives B = 48 a = 5.5 ;  
ref. 141 - 156A - 156B - 156C - 157 - 158A - 158B - 158C -  
159A - 159B - 159C - 160A - 160B - 160C ;
- 1 Sharpening oil stone ;
- 1 Plastic case.

**Set multi - profile 396 - R.**

The set includes :

- 13 Pairs of knives B = 48 a = 5.5 ;  
ref. 156A - 156B - 156C - 157 - 158A - 158B - 158C - 159A -  
159B - 159C - 160A - 160B - 160C ;
- 1 Sharpening oil stone ;
- 1 Plastic case.

**Estuche multiperfiles 396 - C.**

El juego comprende :

- 1 Cabezal Art 394-T Z = 2 ;
- 14 Pares de cuchillas B = 48 a = 5.5 ;  
ref. 141 - 156A - 156B - 156C - 157 - 158A - 158B - 158C -  
159A - 159B - 159C - 160A - 160B - 160C ;
- 1 Afiladora ;
- 1 Estuche de plàstica.

**Estuche multiperfiles 396 - R.**

El juego comprende :

- 13 Pares de cuchillas B = 48 a = 5.5 ;  
ref. 156A - 156B - 156C - 157 - 158A - 158B - 158C - 159A -  
159B - 159C - 160A - 160B - 160C ;
- 1 Afiladora ;
- 1 Estuche de plàstica.

**Coffret multiprofiles 396 - C.**

Le jeu comprend :

- 1 Porte - outils Art 394-T Z = 2 ;
- 14 Paires de couteaux B = 48 a = 5.5 ;  
réf. 141 - 156A - 156B - 156C - 157 - 158A - 158B - 158C -  
159A - 159B - 159C - 160A - 160B - 160C ;
- 1 Pierre à l' huile pour l' affûtage ;
- 1 Coffret en plastique.

**Coffret multiprofiles 396 - R.**

Le jeu comprend :

- 13 Paires de couteaux B = 48 a = 5.5 ;  
réf. 156A - 156B - 156C - 157 - 158A - 158B - 158C - 159A -  
159B - 159C - 160A - 160B - 160C ;
- 1 Pierre à l' huile pour l' affûtage ;
- 1 Coffret en plastique.

**Multi - Profil Satz 396 - C.**

Der Satz besteht aus :

- 1 Messerkopf Art 394-T Z = 2 ;
- 14 Messerpaaren B = 48 a = 5.5 ;  
Profil 141 - 156A - 156B - 156C - 157 - 158A - 158B - 158C -  
159A - 159B - 159C - 160A - 160B - 160C ;
- 1 Schleifölstein ;
- 1 Plastiketui.

**Multi - Profil Satz 396 - R.**

Der Satz besteht aus :

- 13 Messerpaaren B = 48 a = 5.5 ;  
Profil 156A - 156B - 156C - 157 - 158A - 158B - 158C - 159A -  
159B - 159C - 160A - 160B - 160C ;
- 1 Scheifhölstein ;
- 1 Plastiketui.



d	D2	D MAX
30	97	146
31.75	97	146
35	97	146
40	117	167
50	117	167

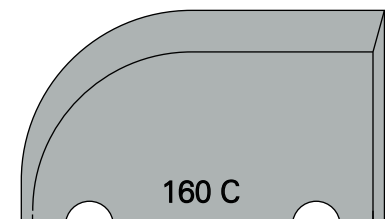
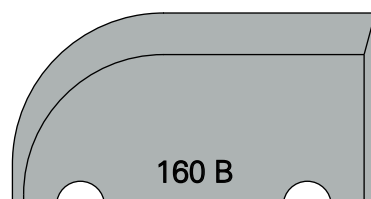
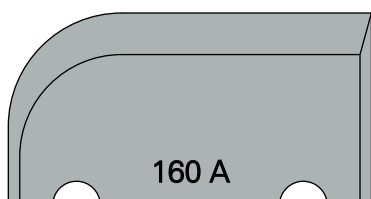
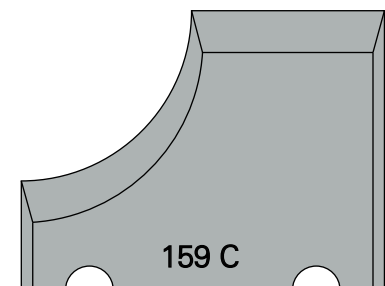
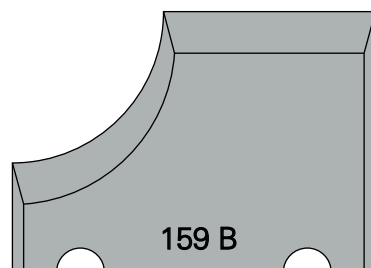
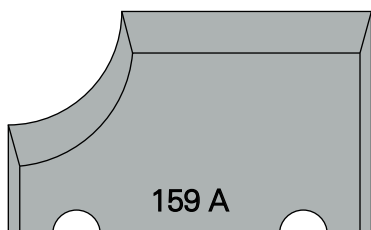
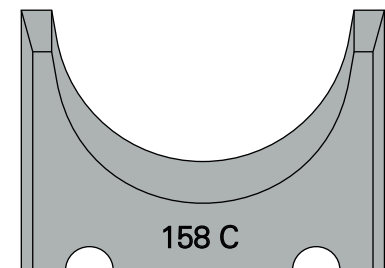
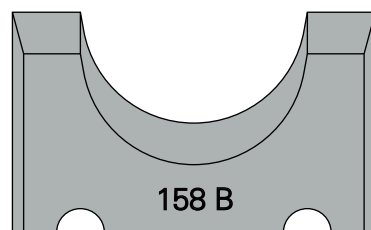
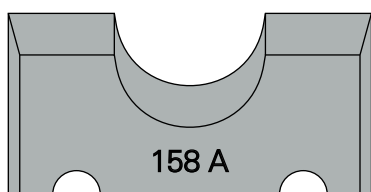
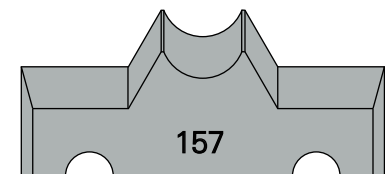
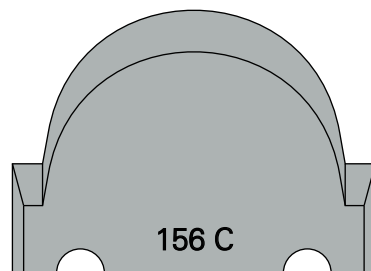
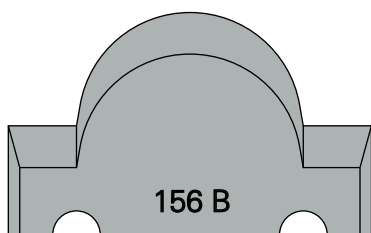
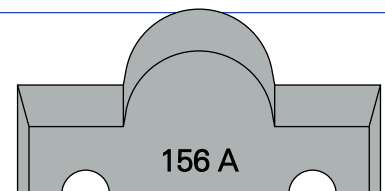
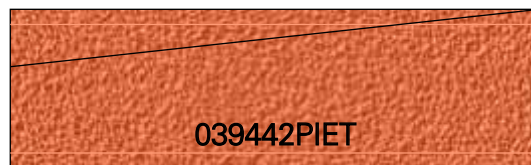
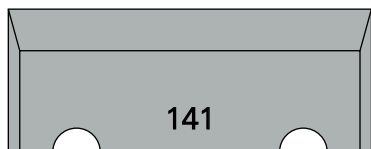
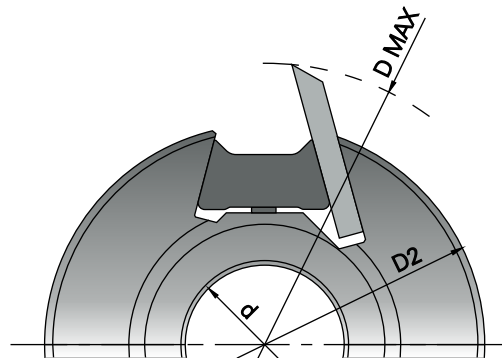





**SP**

**MAN**

D2 = 97 - n 6000 - 8000  
D2 = 117 - n 5900 - 7000

### K 396 - C

Il set è composto da:

- 1 Testa portacoltelli Art K 394-T Z = 2 ;
- 14 Coppie di coltelli B = 48 a = 5.5 ;  
profilo 141 - 156A - 156B - 156C - 157 -  
158A - 158B - 158C - 159A - 159B - 159C -  
160A - 160B - 160C ;
- 14 Coppie di relativi limitatori ;
- 1 Pietra ad olio per l' affilatura ;
- 1 Contenitore in materiale plastico.

### K 396 - R

Il set è composto da:

- 13 Coppie di coltelli B = 48 a = 5.5 ;  
profilo 156A - 156B - 156C - 157 -158A -  
158B - 158C - 159A - 159B - 159C -160A -  
160B - 160C ;
- 13 Coppie di relativi limitatori ;
- 1 Pietra ad olio per l' affilatura ;
- 1 Contenitore in materiale plastico.



ART	d	COD. SET
K396 - C	30	K396C09730
K396 - C	31,75	K396C09731
K396 - C	35	K396C09735
K396 - C	40	K396C11740
K396 - C	50	K396C11750
K396 - R		K396R00000



#### Set multi - profile K 396 - C.

The set includes :

- 1 Cutter head Art K 394-T Z = 2;
- 14 Pairs of knives B = 48 a = 5.5  
ref. 141 - 156A - 156B - 156C - 157 - 158A -158B - 158C -  
159A - 159B - 159C - 160A - 160B - 160C;
- 14 Pairs of chip - limitors ;
- 1 Sharpening oil stone ;
- 1 Plastic case.

#### Set multi - profile K 396 - R.

The set includes :

- 13 Pairs of knives B = 48 a = 5.5  
ref. 156A - 156B - 156C - 157 - 158A -158B - 158C - 159A -  
159B - 159C - 160A - 160B - 160C;
- 13 Pairs of chip - limitors ;
- 1 Sharpening oil stone;
- 1 Plastic case.



#### Estuche multiperfiles K 396 - C.

El juego comprende :

- 1 Cabezal Art K 394-T Z = 2;
- 14 Pares de cuchillas B = 48 a = 5.5  
ref. 141 - 156A - 156B - 156C - 157 - 158A -158B - 158C -  
159A - 159B - 159C - 160A - 160B - 160C;
- 14 Pares de limitadores ;
- 1 Afiladora;
- 1 Estuche de plàstica.

#### Estuche multiperfiles K 396 - R.

El juego comprende :

- 13 Pares de cuchillas B = 48 a = 5.5  
ref. 156A - 156B - 156C - 157 - 158A -158B - 158C - 159A -  
159B - 159C - 160A - 160B - 160C;
- 13 Pares de limitadores ;
- 1 Afiladora;
- 1 Estuche de plàstica.



#### Coffret multiprofiles K 396 - C.

Le jeu comprend :

- 1 Porte - outils Art K 394-T Z = 2;
- 14 Paires de couteaux B = 48 a = 5.5  
réf. 141 - 156A - 156B - 156C - 157 - 158A -158B - 158C -  
159A - 159B - 159C - 160A - 160B - 160C;
- 14 Paires de limiteurs ;
- 1 Pierre à l' huile pour l' affûtage;
- 1 Coffret en plastique.

#### Coffret multiprofiles K 396 - R.

Le jeu comprend :

- 13 Paires de couteaux B = 48 a = 5.5  
réf. 156A - 156B - 156C - 157 - 158A -158B - 158C - 159A -  
159B - 159C - 160A - 160B - 160C;
- 13 Paires de limiteurs ;
- 1 Pierre à l' huile pour l' affûtage;
- 1 Coffret en plastique.



#### Multi - Profil Satz K 396 - C.

Der Satz besteht aus :

- 1 Messerkopf Art K 394-T Z = 2;
- 14 Messerpaaren B = 48 a = 5.5  
Profil 141 - 156A - 156B - 156C - 157 - 158A -158B - 158C -  
159A - 159B - 159C - 160A - 160B - 160C;
- 14 Abweiserpaaren ;
- 1 Schleifölstein;
- 1 Plastiketui.

#### Multi - Profil Satz K 396 - R.

Der Satz besteht aus :

- 13 Messerpaaren B = 48 a = 5.5  
Profil 156A - 156B - 156C - 157 - 158A -158B - 158C - 159A -  
159B - 159C - 160A - 160B - 160C;
- 13 Abweiserpaaren ;
- 1 Scheifhölstein;
- 1 Plastiketui.



d	D2	D MAX
30	97	146
31.75	97	146
35	97	146
40	117	167
50	117	167

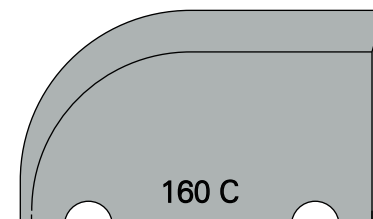
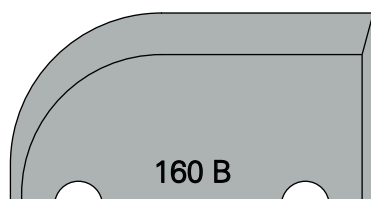
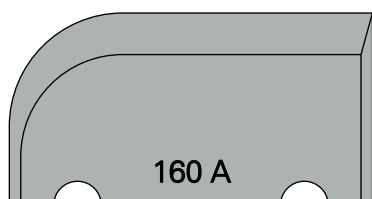
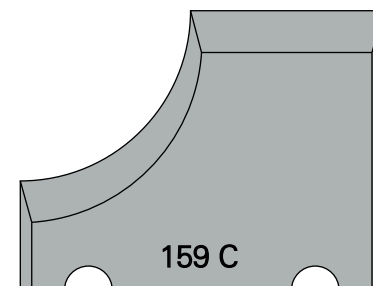
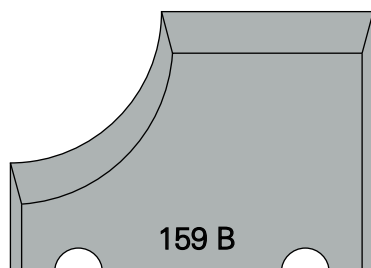
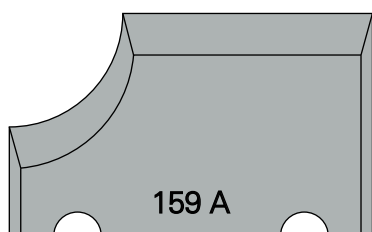
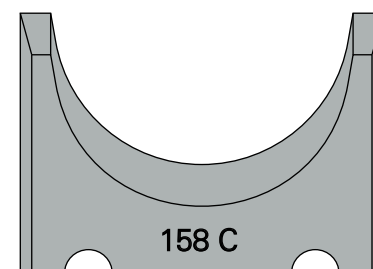
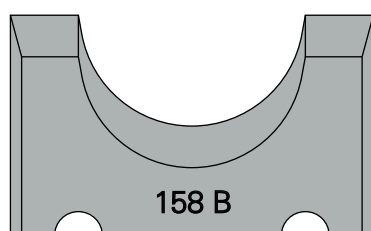
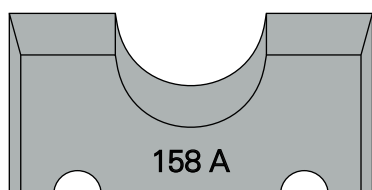
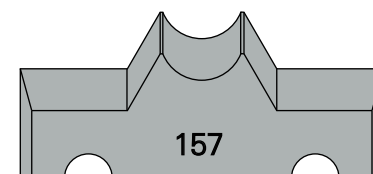
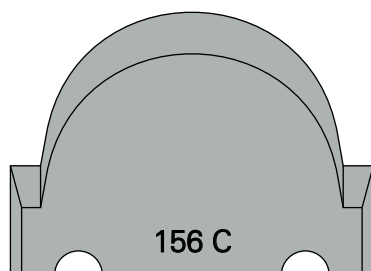
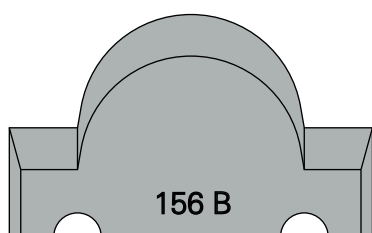
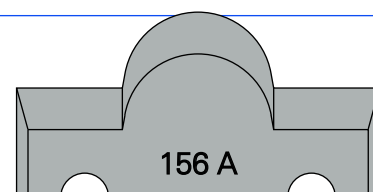
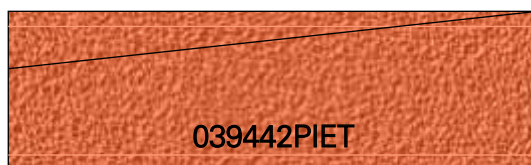
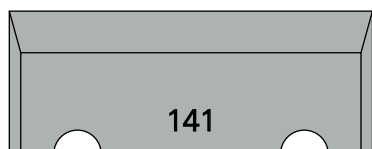
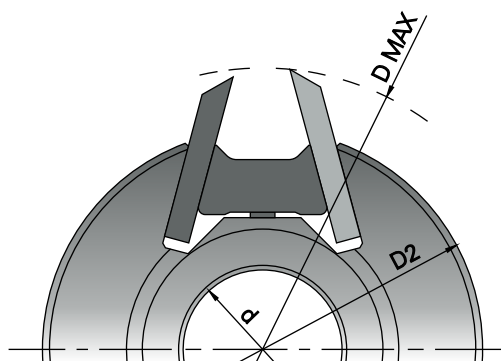



SP

MEC

D2 = 97 - n max 8000  
D2 = 117 - n max 7000

**397 - C**

Il set è composto da:

- 1 Testa portacoltelli Art 394-T Z = 2 ;
- 14 Coppie di coltelli B = 48 a = 5.5 ;  
profilo 141 - 161A - 161B - 162 - 163A -  
163B - 164A - 164B - 165A - 165B - 165C -  
166A - 166B - 166C ;
- 1 Pietra ad olio per l' affilatura ;
- 1 Contenitore in materiale plastico.

**397 - R**

Il set è composto da:

- 13 Coppie di coltelli B = 48 a = 5.5 ;  
profilo 161A - 161B - 162 - 163A - 163B -  
164A - 164B - 165A - 165B - 165C - 166A -  
166B - 166C ;
- 1 Pietra ad olio per l' affilatura ;
- 1 Contenitore in materiale plastico.



ART

d

COD. SET

397 - C	30	0397C09730
397 - C	31,75	0397C09731
397 - C	35	0397C09735
397 - C	40	0397C11740
397 - C	50	0397C11750
397 - R		0397R00000

**Set multi - profile 397 - C.**

The set includes :

- 1 Cutter head Art 394-T Z = 2 ;
- 14 Pairs of knives B = 48 a = 5.5 ;  
ref. 141 - 161A - 161B - 162 - 163A - 163B - 164A - 164B -  
165A - 165B - 165C - 166A - 166B - 166C ;
- 1 Sharpening oil stone ;
- 1 Plastic case.

**Set multi - profile 397 - R.**

The set includes :

- 13 Pairs of knives B = 48 a = 5.5 ;  
ref. 161A - 161B - 162 - 163A - 163B - 164A - 164B - 165A -  
165B - 165C - 166A - 166B - 166C ;
- 1 Sharpening oil stone ;
- 1 Plastic case.

**Estuche multiperfiles 397 - C.**

El juego comprende :

- 1 Cabezal Art 394-T Z = 2 ;
- 14 Pares de cuchillas B = 48 a = 5.5 ;  
ref. 141 - 161A - 161B - 162 - 163A - 163B - 164A - 164B -  
165A - 165B - 165C - 166A - 166B - 166C ;
- 1 Afiladora ;
- 1 Estuche de plàstica.

**Estuche multiperfiles 397 - R.**

El juego comprende :

- 13 Pares de cuchillas B = 48 a = 5.5 ;  
ref. 161A - 161B - 162 - 163A - 163B - 164A - 164B - 165A -  
165B - 165C - 166A - 166B - 166C ;
- 1 Afiladora ;
- 1 Estuche de plàstica.

**Coffret multiprofils 397 - C.**

Le jeu comprend :

- 1 Porte - outils Art 394-T Z = 2 ;
- 14 Paires de couteaux B = 48 a = 5.5 ;  
réf. 141 - 161A - 161B - 162 - 163A - 163B - 164A - 164B -  
165A - 165B - 165C - 166A - 166B - 166C ;
- 1 Pierre à l' huile pour l' affûtage ;
- 1 Coffret en plastique.

**Coffret multiprofils 397 - R.**

Le jeu comprend :

- 13 Paires de couteaux B = 48 a = 5.5 ;  
réf. 161A - 161B - 162 - 163A - 163B - 164A - 164B - 165A -  
165B - 165C - 166A - 166B - 166C ;
- 1 Pierre à l' huile pour l' affûtage ;
- 1 Coffret en plastique.

**Multi - Profil Satz 397 - C.**

Der Satz besteht aus :

- 1 Messerkopf Art 394-T Z = 2 ;
- 14 Messerpaaren B = 48 a = 5.5 ;  
Profil 141 - 161A - 161B - 162 - 163A - 163B - 164A - 164B -  
165A - 165B - 165C - 166A - 166B - 166C ;
- 1 Schleifölstein ;
- 1 Plastiketui.

**Multi - Profil Satz 397 - R.**

Der Satz besteht aus :

- 13 Messerpaaren B = 48 a = 5.5 ;  
Profil 161A - 161B - 162 - 163A - 163B - 164A - 164B -  
165A - 165B - 165C - 166A - 166B - 166C ;
- 1 Scheifhölstein ;
- 1 Plastiketui.



d	D2	D MAX
30	97	146
31.75	97	146
35	97	146
40	117	167
50	117	167

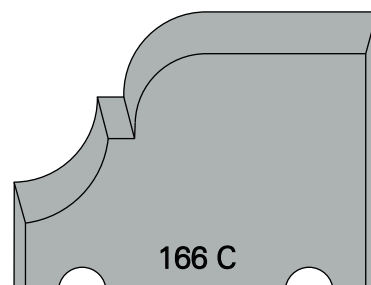
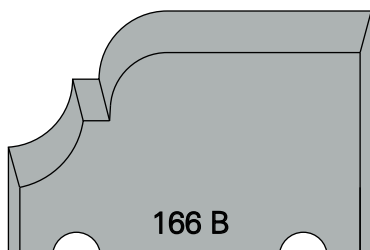
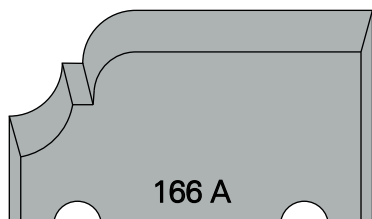
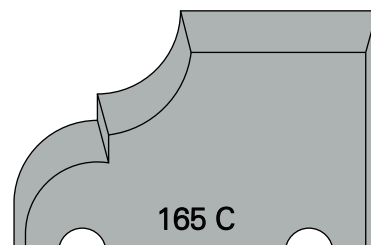
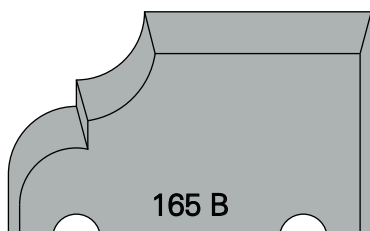
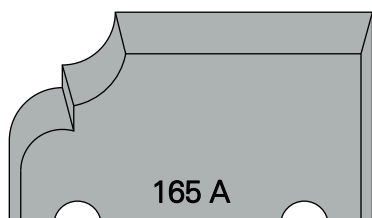
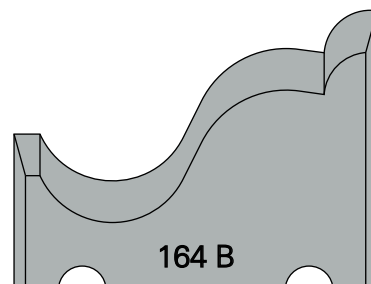
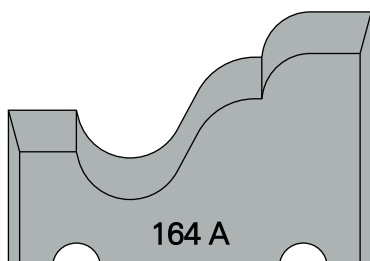
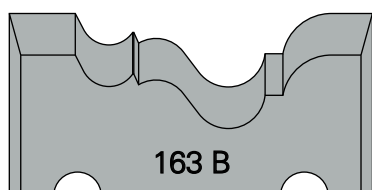
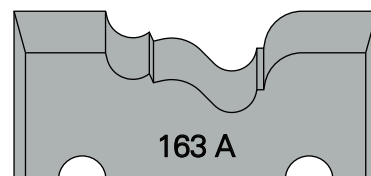
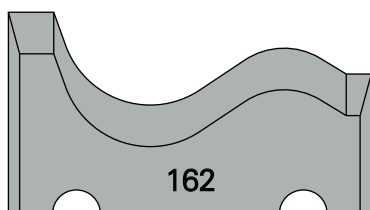
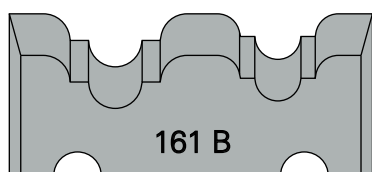
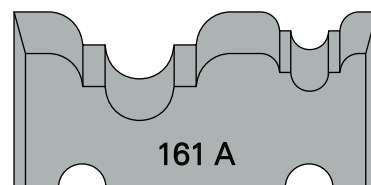
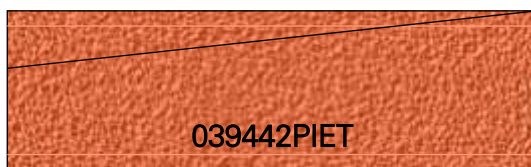
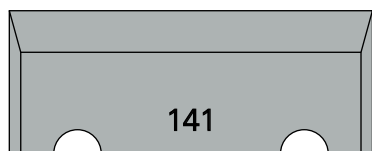
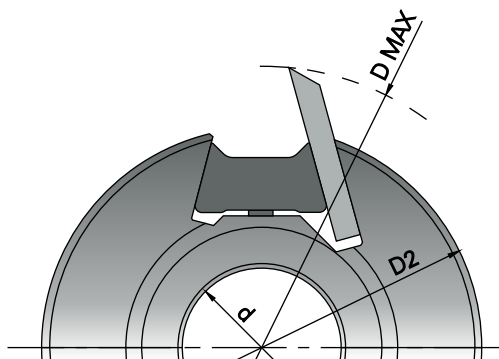



**SP**

**MAN**

D2 = 97 - n 6000 - 8000  
D2 = 117 - n 5900 - 7000

### K 397 - C

Il set è composto da:

- 1 Testa portacoltelli Art K 394-T Z = 2 ;
- 14 Coppie di coltelli B = 48 a = 5.5 ;  
profilo 141 - 161A - 161B - 162 - 163A -  
163B - 164A - 164B - 165A - 165B - 165C -  
166A - 166B - 166C ;
- 14 Coppie di relativi limitatori ;
- 1 Pietra ad olio per l' affilatura ;
- 1 Contenitore in materiale plastico.

### K 397 - R

Il set è composto da:

- 13 Coppie di coltelli B = 48 a = 5.5 ;  
profilo 161A - 161B - 162 - 163A - 163B -  
164A - 164B - 165A - 165B - 165C - 166A -  
166B - 166C ;
- 13 Coppie di relativi limitatori ;
- 1 Pietra ad olio per l' affilatura ;
- 1 Contenitore in materiale plastico.



ART

d

COD. SET

K397 - C	30	K397C09730
K397 - C	31.75	K397C09731
K397 - C	35	K397C09735
K397 - C	40	K397C11740
K397 - C	50	K397C11750
K397 - R		K397R00000



#### Set multi - profile K 397 - C.

The set includes :

- 1 Cutter head Art K 394-T Z = 2;
- 14 Pairs of knives B = 48 a = 5.5  
ref. 141 - 161A - 161B - 162 - 163A - 163B - 164A - 164B -  
165A - 165B - 165C - 166A - 166B - 166C;
- 14 Pairs of chip - limitors ;
- 1 Sharpening oil stone ;
- 1 Plastic case.

#### Set multi - profile K 397 - R.

The set includes :

- 13 Pairs of knives B = 48 a = 5.5  
ref. 161A - 161B - 162 - 163A - 163B - 164A - 164B - 165A -  
165B - 165C - 166A - 166B - 166C;
- 13 Pairs of chip - limitors ;
- 1 Sharpening oil stone;
- 1 Plastic case.



#### Estuche multiperfiles K 397 - C.

El juego comprende :

- 1 Cabezal Art K 394-T Z = 2;
- 14 Pares de cuchillas B = 48 a = 5.5  
ref. 141 - 161A - 161B - 162 - 163A - 163B - 164A - 164B -  
165A - 165B - 165C - 166A - 166B - 166C;
- 14 Pares de limitadores ;
- 1 Afiladora;
- 1 Estuche de plàstica.

#### Estuche multiperfiles K 397 - R.

El juego comprende :

- 13 Pares de cuchillas B = 48 a = 5.5  
ref. 161A - 161B - 162 - 163A - 163B - 164A - 164B - 165A -  
165B - 165C - 166A - 166B - 166C;
- 13 Pares de limitadores ;
- 1 Afiladora;
- 1 Estuche de plàstica.



#### Coffret multiprofiles K 397 - C.

Le jeu comprend :

- 1 Porte - outils Art K 394-T Z = 2;
- 14 Paires de couteaux B = 48 a = 5.5  
réf. 141 - 161A - 161B - 162 - 163A - 163B - 164A - 164B -  
165A - 165B - 165C - 166A - 166B - 166C;
- 14 Paires de limiteurs ;
- 1 Pierre à l' huile pour l' affûtage;
- 1 Coffret en plastique.

#### Coffret multiprofiles K 397 - R.

Le jeu comprend :

- 13 Paires de couteaux B = 48 a = 5.5  
réf. 161A - 161B - 162 - 163A - 163B - 164A - 164B - 165A -  
165B - 165C - 166A - 166B - 166C;
- 13 Paires de limiteurs ;
- 1 Pierre à l' huile pour l' affûtage;
- 1 Coffret en plastique.



#### Multi - Profil Satz K 397 - C.

Der Satz besteht aus :

- 1 Messerkopf Art K 394-T Z = 2;
- 14 Messerpaaren B = 48 a = 5.5  
Profil 141 - 161A - 161B - 162 - 163A - 163B - 164A - 164B -  
165A - 165B - 165C - 166A - 166B - 166C;
- 14 Abweiserpaaren ;
- 1 Schleifölstein;
- 1 Plastiketui.

#### Multi - Profil Satz K 397 - R.

Der Satz besteht aus :

- 13 Messerpaaren B = 48 a = 5.5  
Profil 161A - 161B - 162 - 163A - 163B - 164A - 164B -  
165A - 165B - 165C - 166A - 166B - 166C;
- 13 Abweiserpaaren ;
- 1 Scheifölstein;
- 1 Plastiketui.



d	D2	D MAX
30	97	146
31.75	97	146
35	97	146
40	117	167
50	117	167

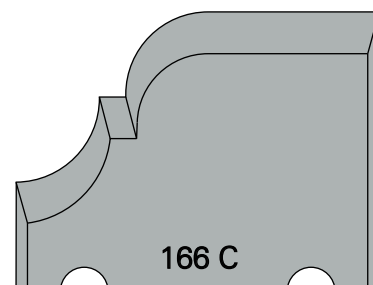
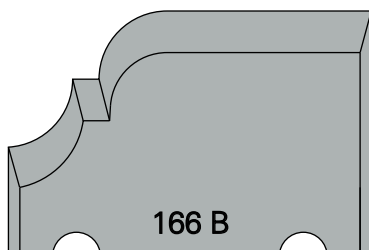
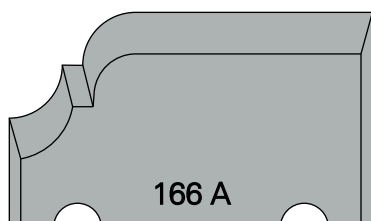
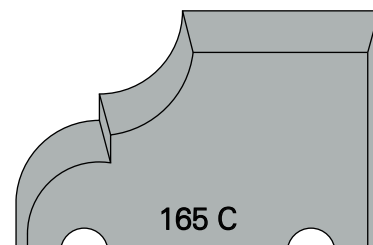
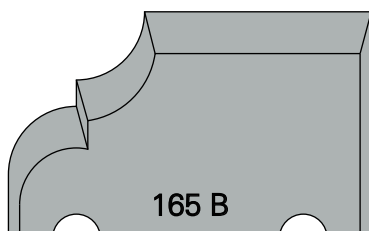
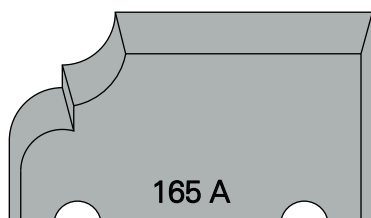
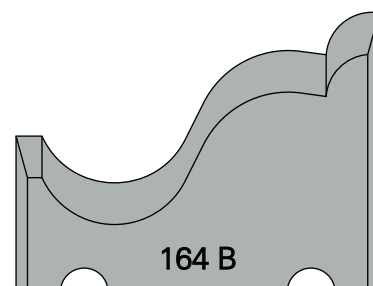
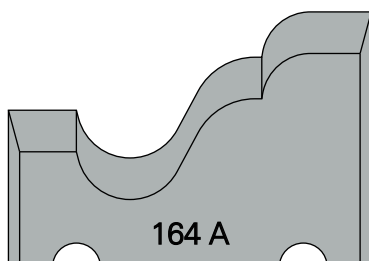
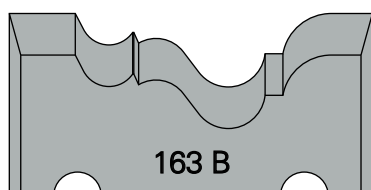
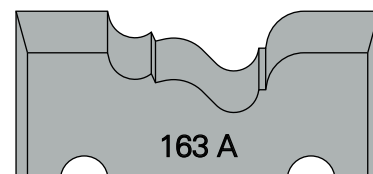
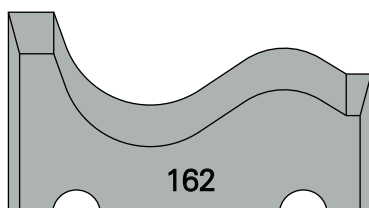
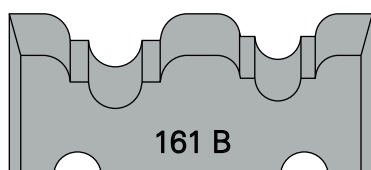
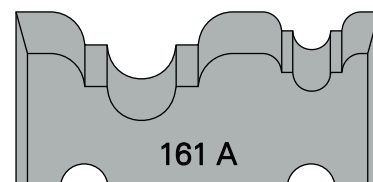
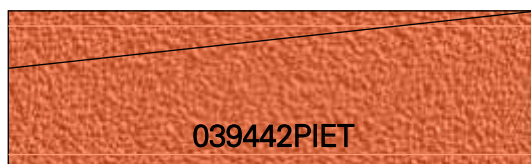
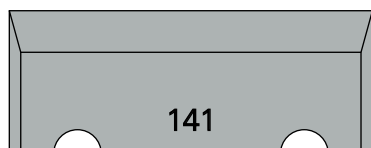
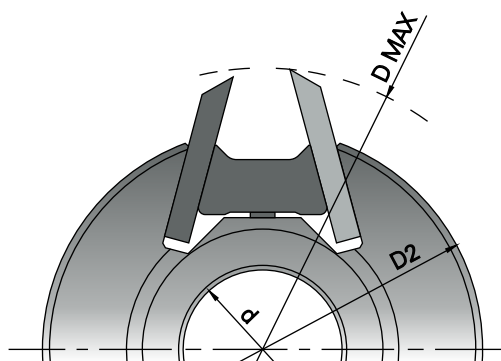

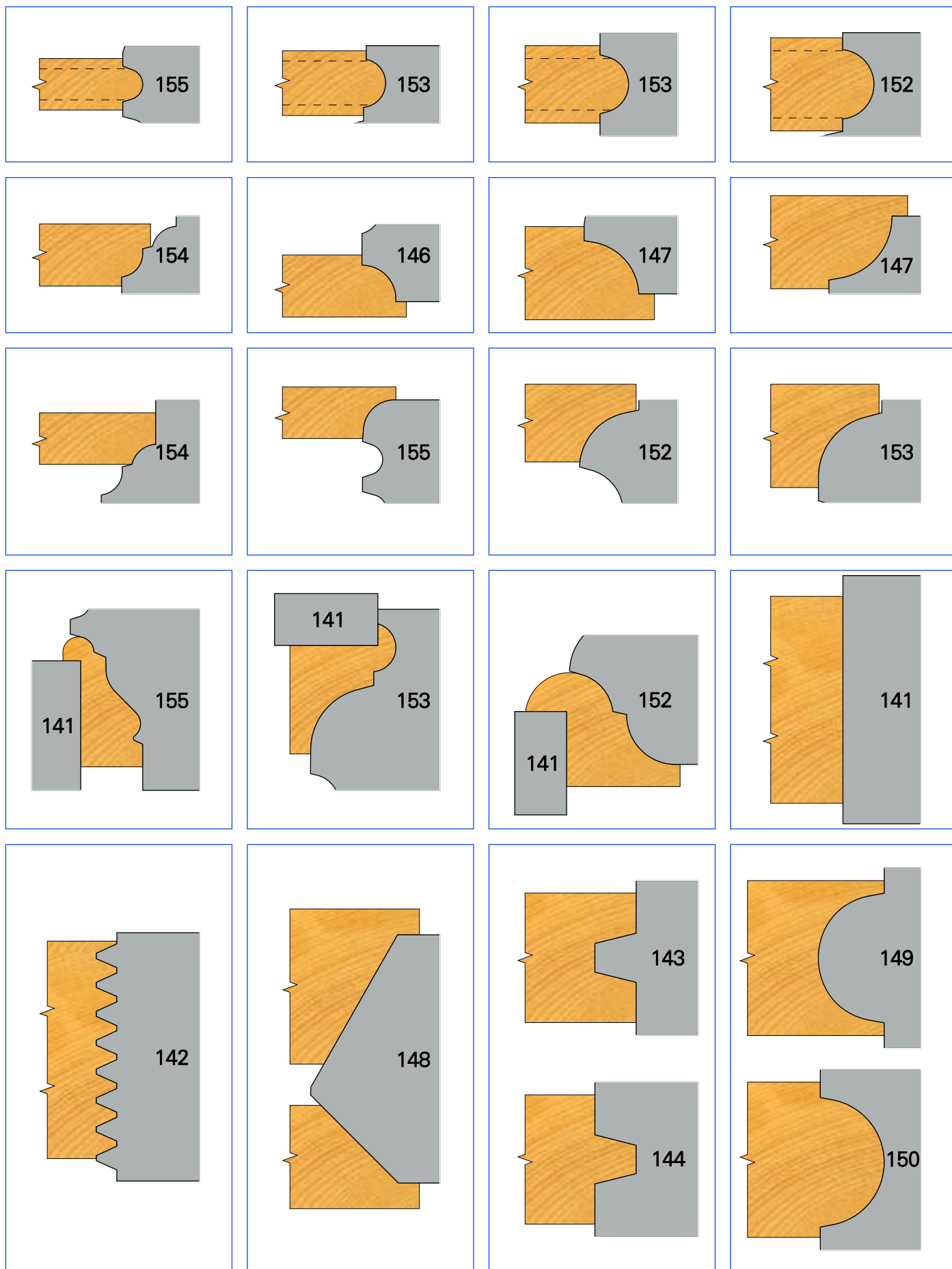

Examples of workable profiles.



Ejemplos de perfiles realizables.





Exemples de profils réalisables.

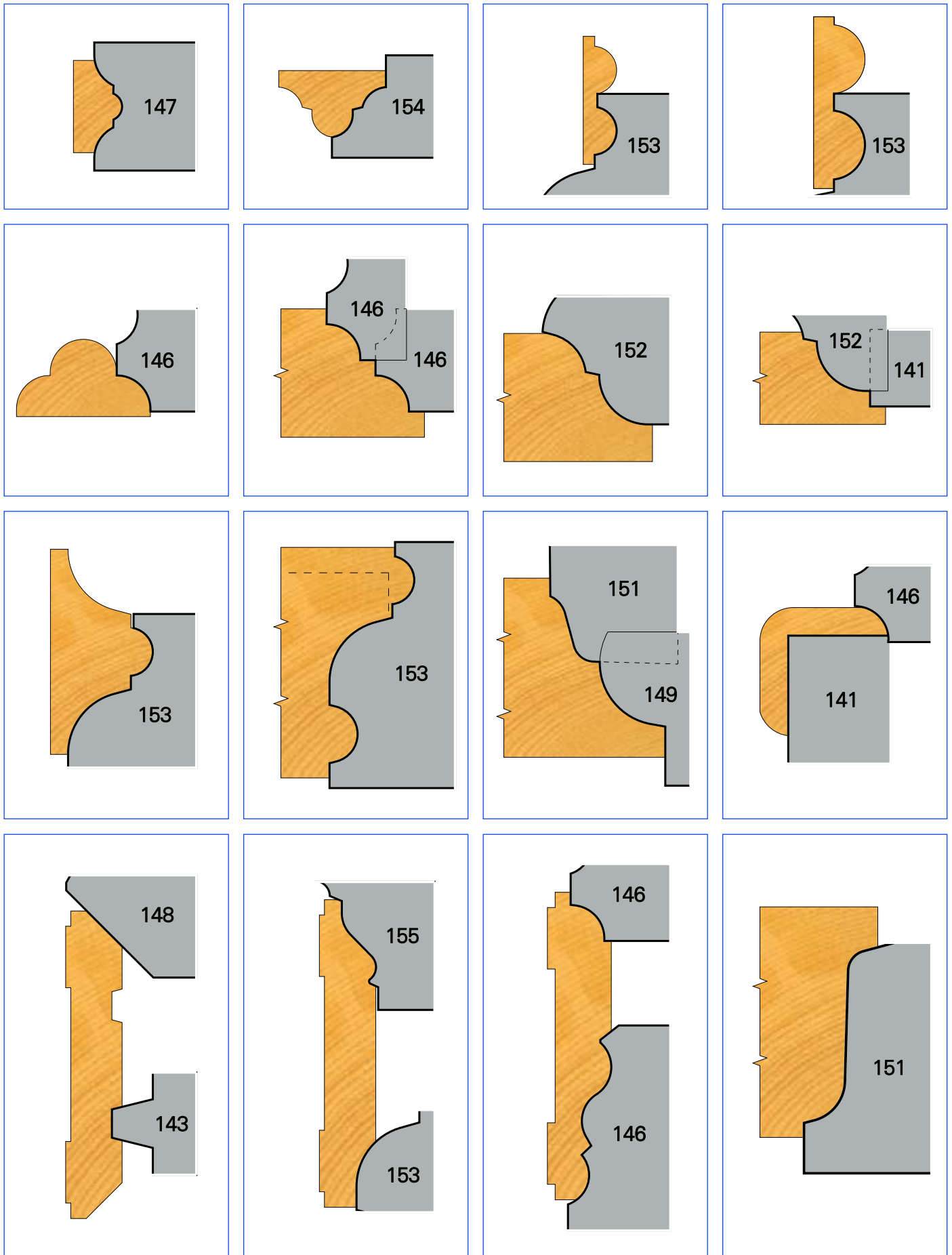

Durchführbaren Profilbeispiele.



 Examples of workable profiles.

 Ejemplos de perfiles realizables.

 Exemples de profils réalisables.

 Durchführbaren Profilbeispiele.





Examples of workable profiles.



Ejemplos de perfiles realizables.





Exemples de profils réalisables.

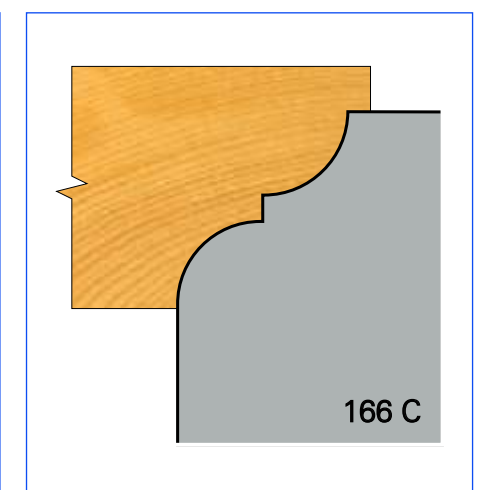
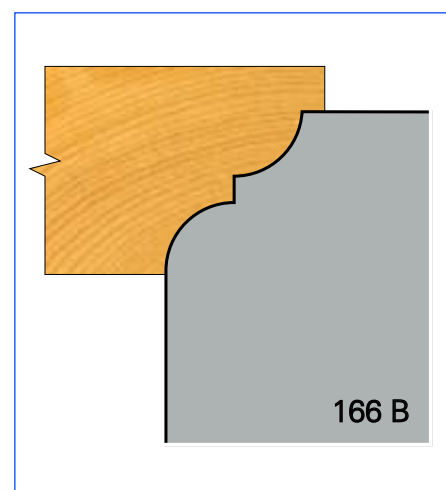
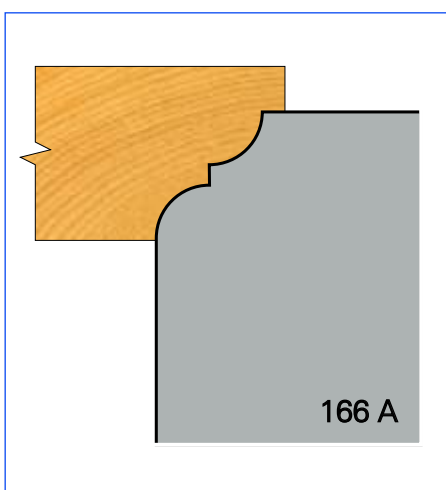
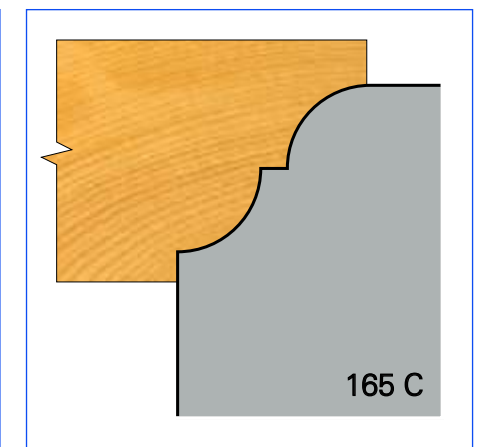
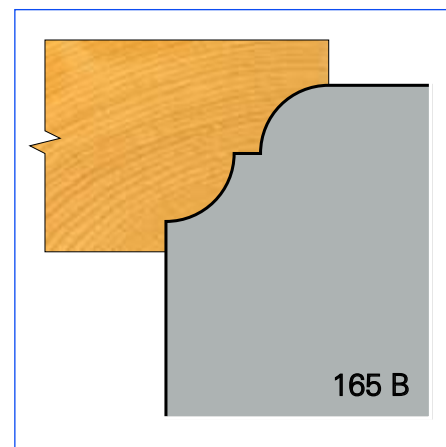
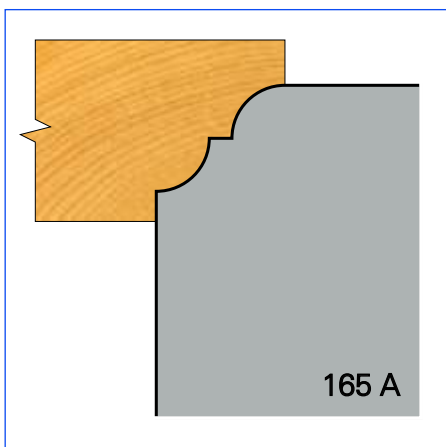
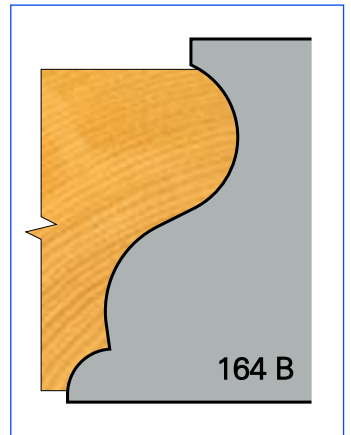
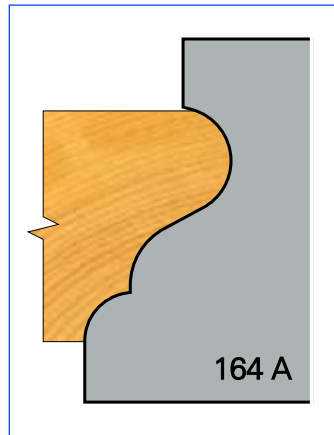
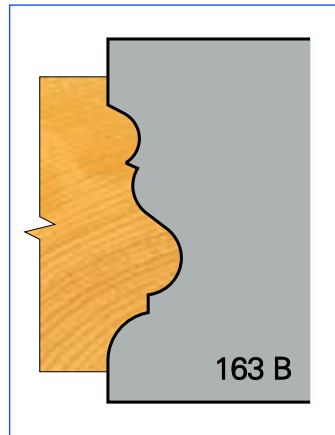
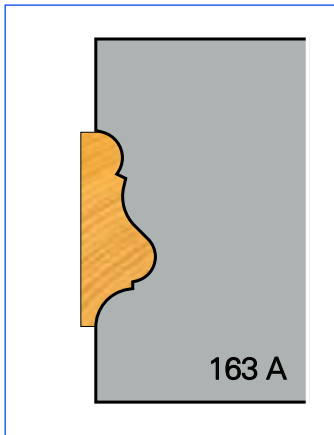
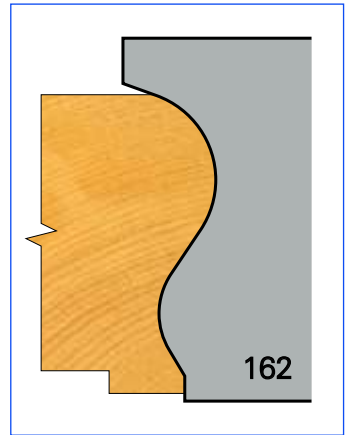
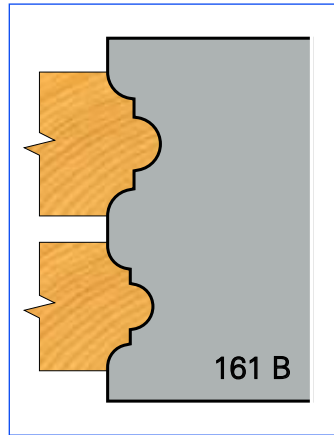
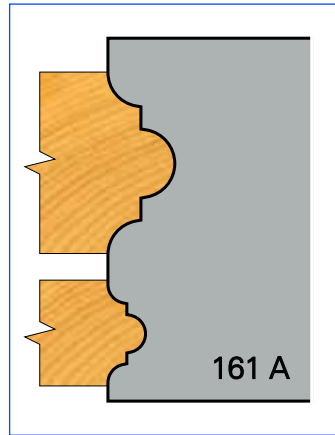
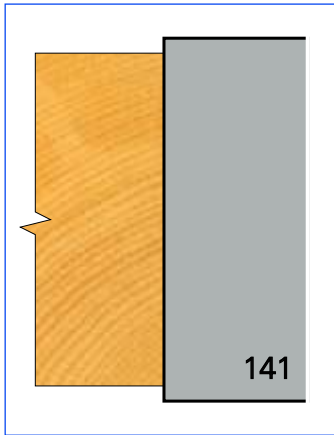

Durchführbaren Profilbeispiele.



 Examples of workable profiles.

 Ejemplos de perfiles realizables.

 Exemples de profils réalisables.

 Durchführbaren Profilbeispiele.

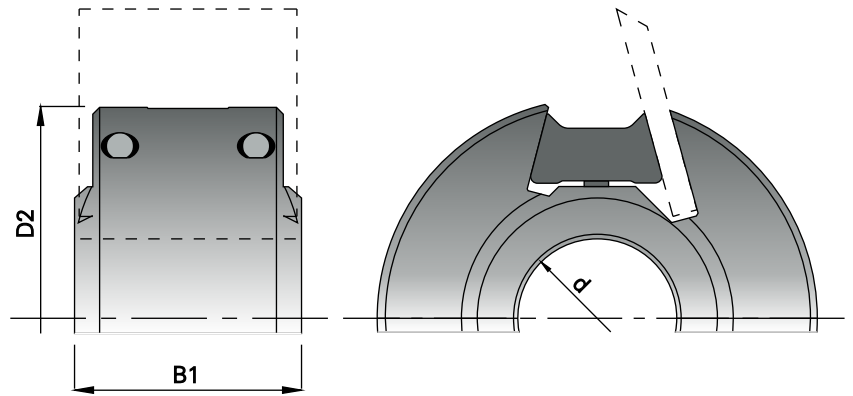

**MEC**

D2 = 97 - n max 8000  
D2 = 117 - n max 7000

D2	B1	d	Z	COD.
97	50	30	2	0394T09730
97	50	31.75	2	0394T09731
97	50	35	2	0394T09735
117	50	40	2	0394T11740
117	50	50	2	0394T11750

Ricambi / Spare parts / Rechanges / Repuestos / Ersatzteile

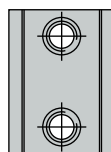

COD.  
048053394T



COD.  
0480700815

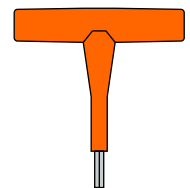

COD.  
0480784000

Cutter head.

Cabezal.

Porte - outils.

Messerkopf.

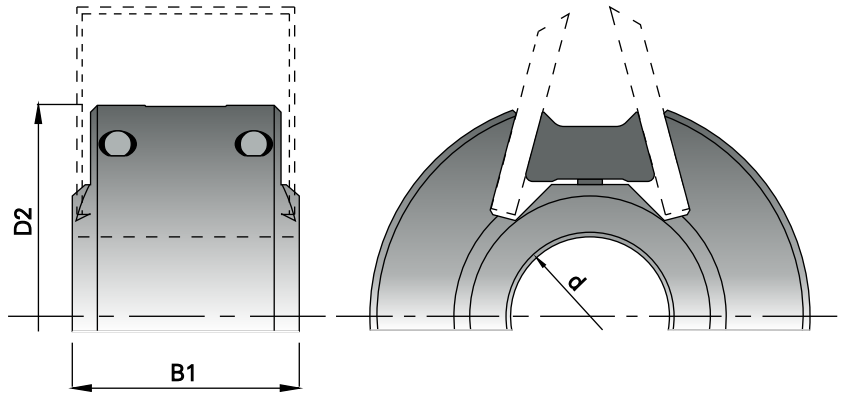

**MAN**

D2 = 97 - n 6000 - 8000  
D2 = 117 - n 5900 - 7000

D2	B1	d	Z	COD.
97	50	30	2	K394T09730
97	50	31.75	2	K394T09731
97	50	35	2	K394T09735
117	50	40	2	K394T11740
117	50	50	2	K394T11750

### Ricambi / Spare parts / Rechanges / Repuestos / Ersatzteile

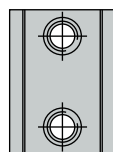

COD.

048053394T



COD.

0480700815

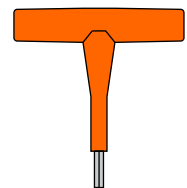

COD.

0480784000

Cutter head.





Cabezal.

Porte - outils.

Messerkopf.



SP

PROFILO	COLTELLI	LIMITATORI
 PROFILE	KNIVES	CHIP - LIMITORS
 PROFIL	COUTEAUX	LIMITEURS
 PERFIL	CUCHILLAS	LIMITADORES
 PROFIL	MESSER	ABWEISER
	COD. COPPIA / PAIR	COD. COPPIA / PAIR
141	0394F01410	0394L01410
142	0394F01420	0394L01420
143	0394F01430	0394L01430
144	0394F01440	0394L01440
146	0394F01460	0394L01460
147	0394F01470	0394L01470
148	0394F01480	0394L01480
149	0394F01490	0394L01490
150	0394F01500	0394L01500
151	0394F01510	0394L01510
152	0394F01520	0394L01520
153	0394F01530	0394L01530
154	0394F01540	0394L01540
155	0394F01550	0394L01550
156A	0396F0156A	0396L0156A
156B	0396F0156B	0396L0156B
156C	0396F0156C	0396L0156C
157	0396F01570	0396L01570
158A	0396F0158A	0396L0158A
158B	0396F0158B	0396L0158B
158C	0396F0158C	0396L0158C
159A	0396F0159A	0396L0159A
159B	0396F0159B	0396L0159B
159C	0396F0159C	0396L0159C
160A	0396F0160A	0396L0160A
160B	0396F0160B	0396L0160B
160C	0396F0160C	0396L0160C
161A	0397F0161A	0397L0161A
161B	0397F0161B	0397L0161B
162	0397F01620	0397L01620
163A	0397F0163A	0397L0163A
163B	0397F0163B	0397L0163B
164A	0397F0164A	0397L0164A
164B	0397F0164B	0397L0164B
165A	0397F0165A	0397L0165A
165B	0397F0165B	0397L0165B
165C	0397F0165C	0397L0165C
166A	0397F0166A	0397L0166A
166B	0397F0166B	0397L0166B
166C	0397F0166C	0397L0166C

 Profiled knives and chip-limiters for cutter heads Art. 394 - T and K 394 - T.

 Cuchillas perfiladas y limitadores para cabezales Art. 394 - T y K 394 - T.

 Conteaux profilés et limiteurs pour porte-outils Art. 394 - T et K 394 - T.

 Profilmesser und Abweiser für Messerköpfe Art. 394 - T und K 394 - T.

# 140 - S

## Coltelli e limitatori profilati su richiesta per teste Art 394 - T e K 394 - T



SP

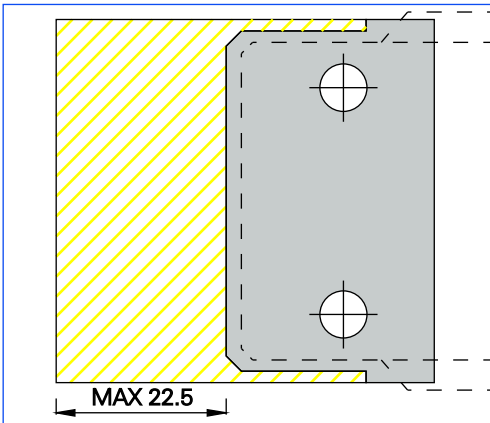
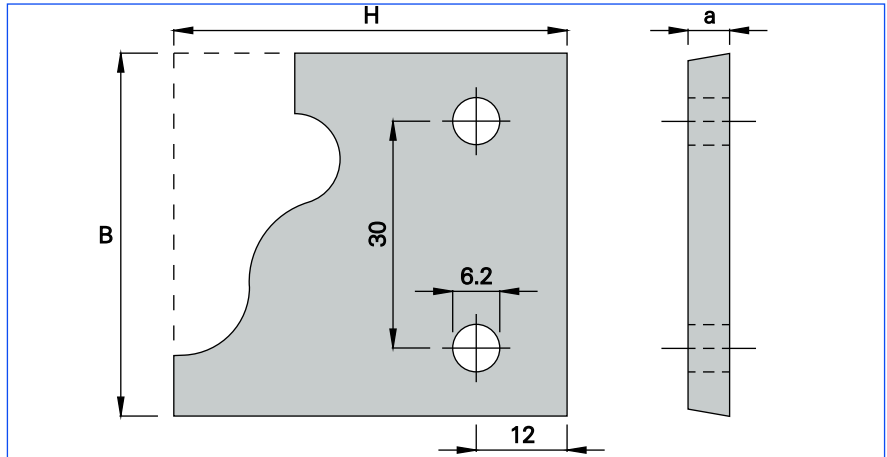

	B	H	a	COD. COPPIA / PAIR
Coltelli / Knives	48	28 - 52	5.5	0394F0140S
Limitatori / Chip limitors	46	27 - 51	5.5	0394L0140S

AREA PROFILABILE / PROFILING AREA

Cutting knives and chip - limitors with customer - made profile for cutter heads Art 394 - T and K 394 - T.

Cuchillas y limitadores abastecidos sobre dibujo para cabezales Art 394 - T y K 394 - T.

Couteaux et limiteurs profilés sur demande pour porte - outils Art 394 - T et K 394 - T.

Profilmesser und Abweiser in Sonderfertigung für Messerkopf Art 394 - T und K 394 - T.

# 140 - A

## Placchette temprate da profilare per teste Art 394 - T e K 394 - T



SP

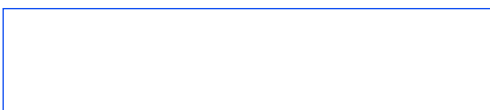
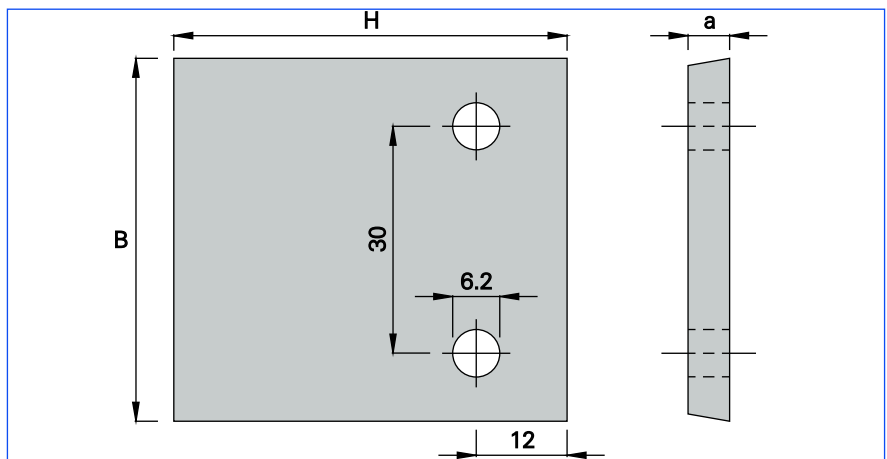

B	H	a	COD. COPPIA / PAIR
48	52	5.5	0394F0140A

Blank plates in tempered steel for cutter heads Art 394 - T and K 394 - T.

Placas para perfilar en acero templado para cabezales Art 394 - T y K 394 - T.

Plaquettes à profiler en acier trempé pour porte - outils Art 394 - T et K 394 - T.

Unprofilierter Platten in gehärteten Stahl für Messerkopf Art 394 - T und K 394 - T.

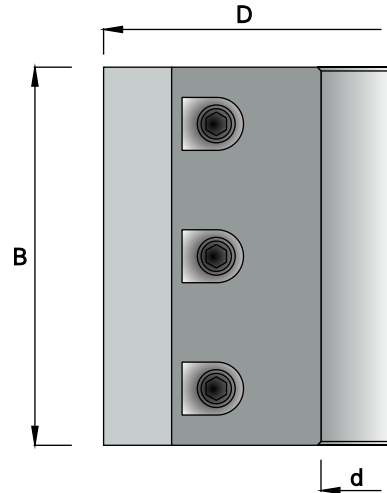

**MEC**

D 122 n max 9000  
D 137 n max 8000

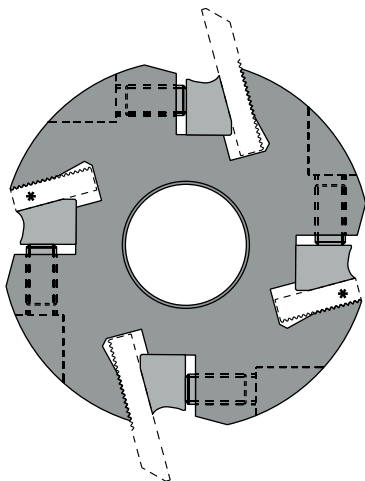
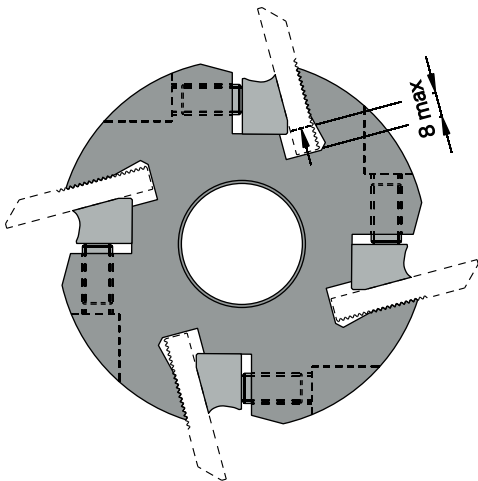

\* FALSO COLTELLO  
\* BLIND KNIFE

D	B	d	Z	COD.
122	40	30	4	0383204030
122	40	31.75	4	0383204031
122	40	35	4	0383204035
122	40	40	4	0383204040
122	60	30	4	0383206030
122	60	31.75	4	0383206031
122	60	35	4	0383206035
122	60	40	4	0383206040
122	80	30	4	0383208030
122	80	31.75	4	0383208031
122	80	35	4	0383208035
122	80	40	4	0383208040
122	100	40	4	0383210040
122	130	40	4	0383213040
122	150	40	4	0383215040
122	180	40	4	0383218040
122	230	40	4	0383223040

D	B	d	Z	COD.
137	50	40	4	0383305040
137	60	40	4	0383306040
137	80	40	4	0383308040
137	100	40	4	0383310040
137	130	40	4	0383313040
137	150	40	4	0383315040
137	180	40	4	0383318040



Cutter head with back serrated knives.



Cabezal porta-cuchillas estriadas.



Porte-outils pour couteaux crantés.



Messerkopf mit rückenverzahnten Blanketts.

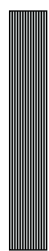
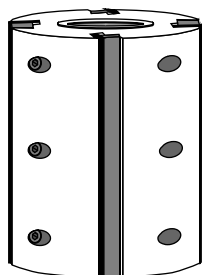

## Ricambi / Spare parts / Rechanges / Repuestos / Ersatzteile

 Falso coltello  
Blind knife

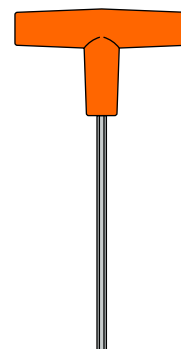
 Cunei di serraggio  
Wedges

COD.	COD.	COD.	COD.	COD.
0383204030	048050F040	048050T040	0480711020	048078L500
0383204031	048050F040	048050T040	0480711020	048078L500
0383204035	048050F040	048050T040	0480711020	048078L500
0383204040	048050F040	048050T040	0480711020	048078L500
0383305040	048050F050	048050T050	0480711020	048078L500
0383206030	048050F060	048050T060	0480711020	048078L500
0383206031	048050F060	048050T060	0480711020	048078L500
0383206035	048050F060	048050T060	0480711020	048078L500
0383206040	048050F060	048050T060	0480711020	048078L500
0383306040	048050F060	048050T060	0480711020	048078L500
0383208030	048050F080	048050T080	0480711020	048078L500
0383208031	048050F080	048050T080	0480711020	048078L500
0383208035	048050F080	048050T080	0480711020	048078L500
0383208040	048050F080	048050T080	0480711020	048078L500
0383308040	048050F080	048050T080	0480711020	048078L500
0383210040	048050F100	048050T100	0480711020	048078L500
0383310040	048050F100	048050T100	0480711020	048078L500
0383213040	048050F130	048050T130	0480711020	048078L500
0383313040	048050F130	048050T130	0480711020	048078L500
0383215040	048050F150	048050T150	0480711020	048078L500
0383315040	048050F150	048050T150	0480711020	048078L500
0383218040	048050F180	048050T180	0480711020	048078L500
0383318040	048050F180	048050T180	0480711020	048078L500
0383223040	048050F230	048050T230	0480711020	048078L500



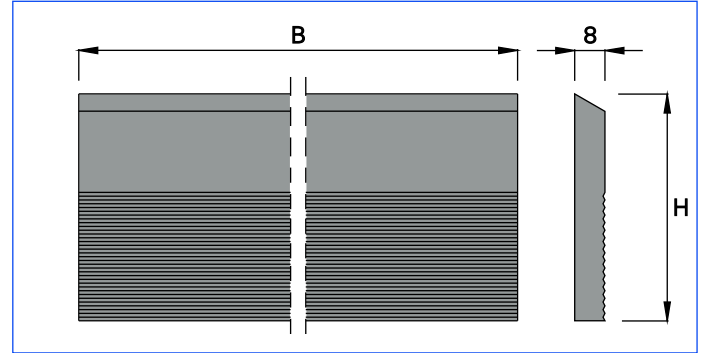

HS

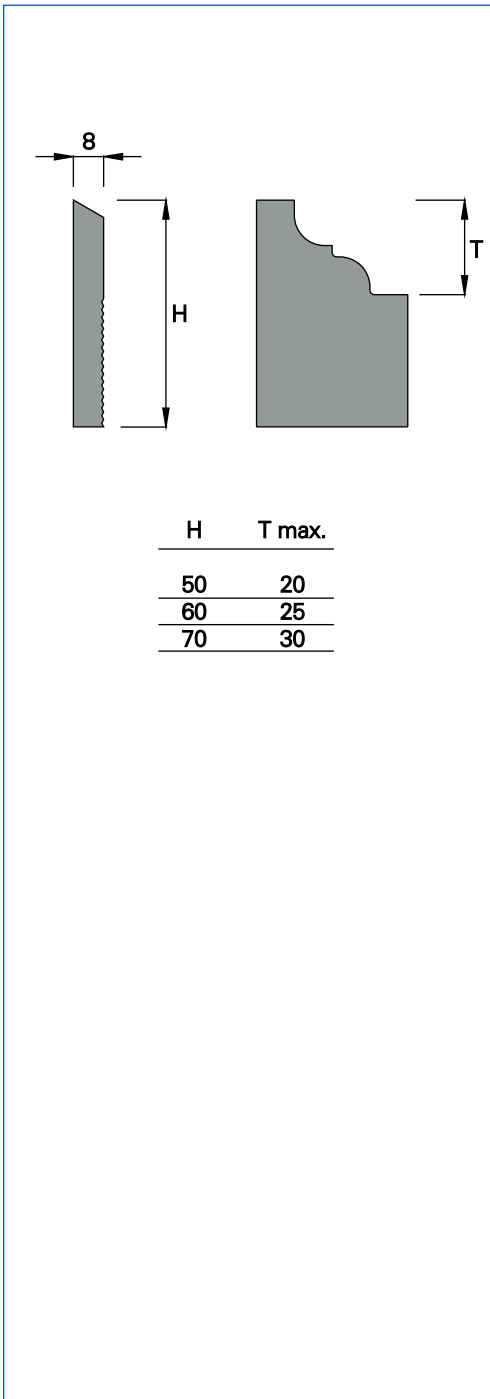

B	H	COD.
40	50	0387R04050
50	50	0387R05050
60	50	0387R06050
80	50	0387R08050
100	50	0387R10050
130	50	0387R13050
150	50	0387R15050
180	50	0387R18050
230	50	0387R23050
650	50	0387R65050
40	60	0387R04060
50	60	0387R05060
60	60	0387R06060
80	60	0387R08060
100	60	0387R10060
130	60	0387R13060
150	60	0387R15060
180	60	0387R18060
230	60	0387R23060
650	60	0387R65060
40	70	0387R04070
50	70	0387R05070
60	70	0387R06070
80	70	0387R08070
100	70	0387R10070
130	70	0387R13070
150	70	0387R15070
180	70	0387R18070
230	70	0387R23070
650	70	0387R65070



Blank serrated back knives.



Cuchillas estriadas para perfilar.



Couteaux bruts crantés.





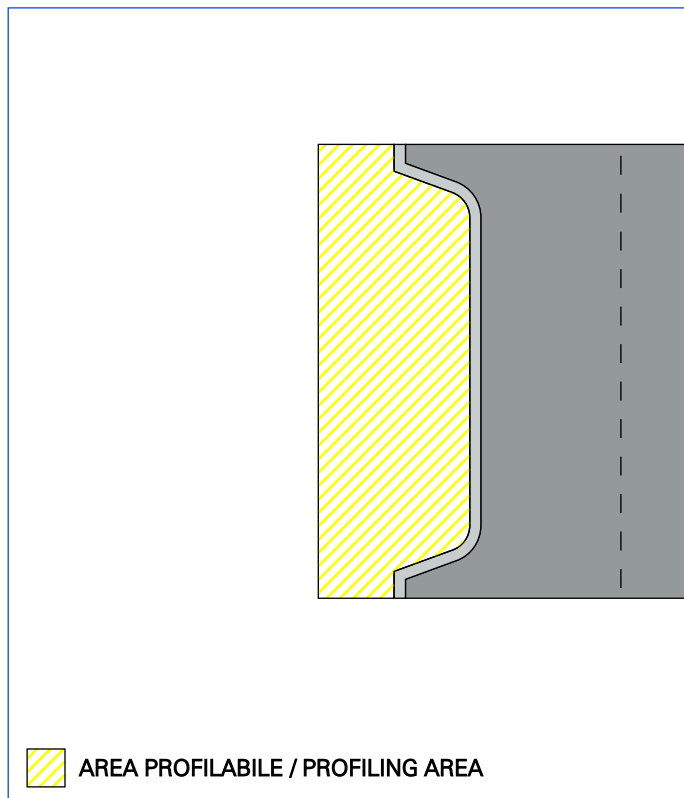

Rückenverzahnte blanketts.







 AREA PROFILABILE / PROFILING AREA

#### Inserti profilati in HW Art.402/403 - P

	TC profiled inserts Art.402/403 - P.
	Plaquettes profilées en HW Art.402/403 - P.
	Cuchillas perfiladas de HW Art.402/403 - P.
	HW - Profilplatten Art.402/403 - P.

#### Piastrine di supporto profilate Art.401-P

	Profiled support plates Art.401 - P.
	Plaquettes de support profilées Art.401 - P.
	Plaquetas de soporte perfiladas Art.401 - P.
	Profil-Stützplatten Art.401 - P.

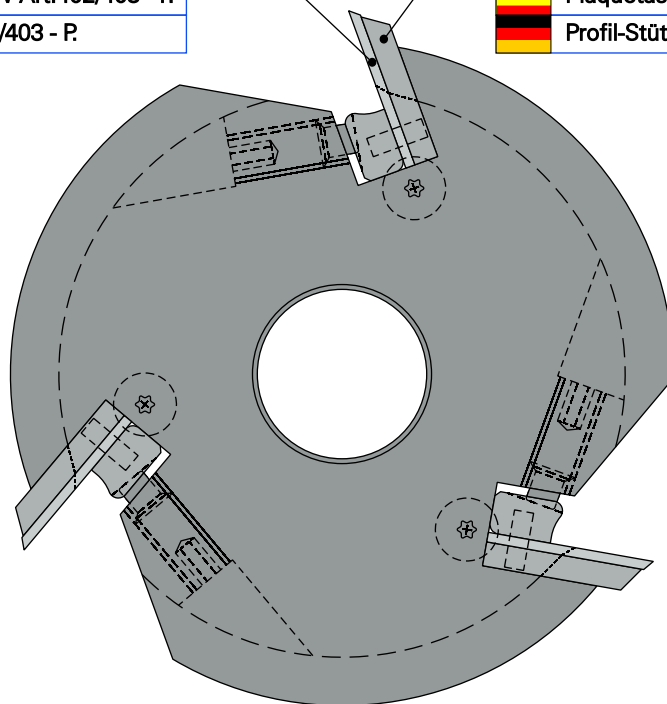

 Multi - profile cutter heads, with profiled inserts.

 Cabezales multiperfil con cuchillas perfiladas.

 Porte - outils multiprofilés avec plaquettes profilées.

 Multiprofil - Messerköpfe, mit Profilplatten.

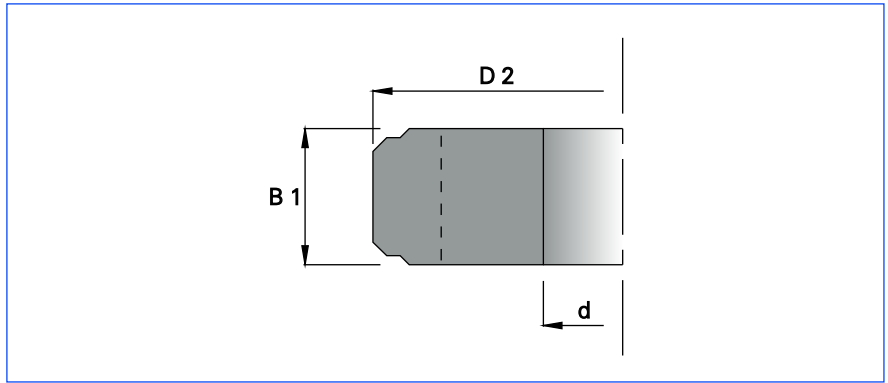

**HW**

**MEC**

n max 7000

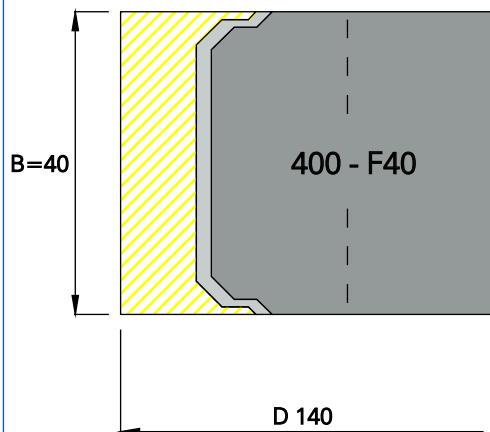
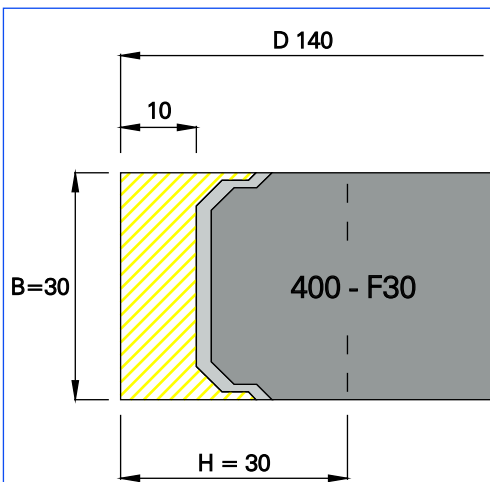

AREA PROFILABILE / PROFILING AREA

ART.	D 2	B 1	d	Z	COD.
400 - F30	116	30	30	3	0400F30030
	116	30	31.75	3	0400F30031
	116	30	35	3	0400F30035
	116	30	40	3	0400F30040
	116	30	50	3	0400F30050

ART.	B	H	a	COD.
401 - P	30	30	5	0401P30305

ART.	B	H	a	COD.
402 - P	30	30	2	0402P30302

ART.	B	H	a	COD.
403 - P	30	30	3	0403P30303

ART.	D 2	B 1	d	Z	COD.
400 - F40	116	40	30	3	0400F40030
	116	40	31.75	3	0400F40031
	116	40	35	3	0400F40035
	116	40	40	3	0400F40040
	116	40	50	3	0400F40050

ART.	B	H	a	COD.
401 - P	40	30	5	0401P40305

ART.	B	H	a	COD.
402 - P	40	30	2	0402P40302

ART.	B	H	a	COD.
403 - P	40	30	3	0403P40303

Multi - profiles cutter heads.

Cabezales multiperfiles.

Porte - outils multiprofiles.

Multiprofil - Messerköpfe.

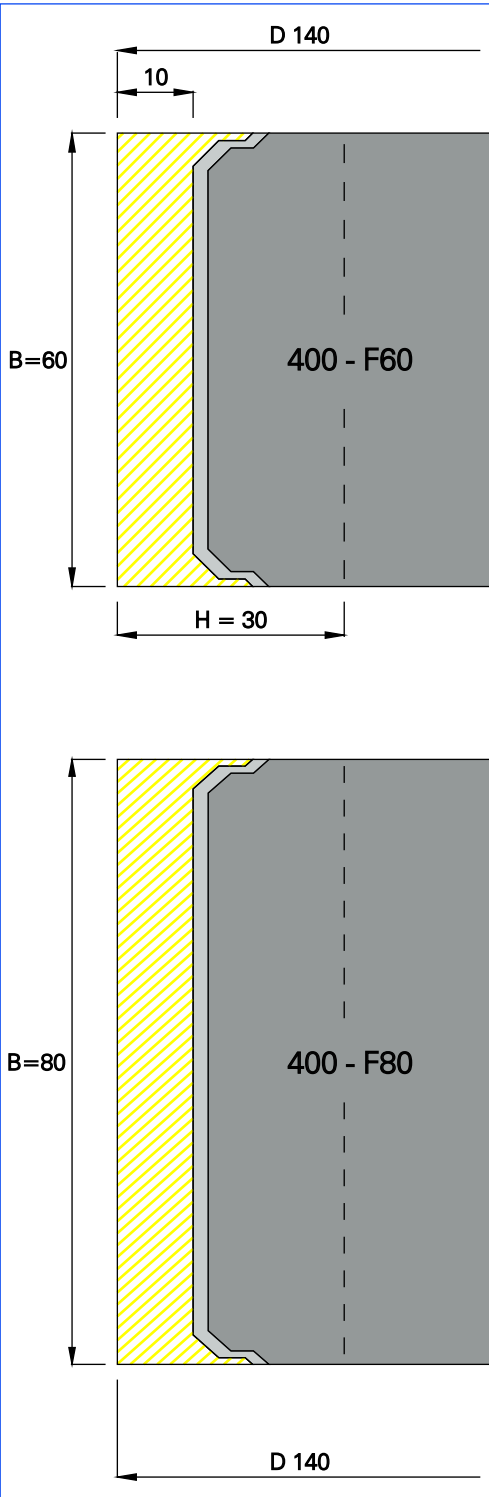

ART.	D 2	B 1	d	Z	COD.
400 - F60	116	60	30	3	0400F60030
	116	60	31.75	3	0400F60031
	116	60	35	3	0400F60035
	116	60	40	3	0400F60040
	116	60	50	3	0400F60050

ART.	B	H	a	COD.
401 - P	60	30	5	0401P60305

ART.	B	H	a	COD.
402 - P	60	30	2	0402P60302

ART.	B	H	a	COD.
403 - P	60	30	3	0403P60303

ART.	D 2	B 1	d	Z	COD.
400 - F80	116	80	30	3	0400F80030
	116	80	31.75	3	0400F80031
	116	80	35	3	0400F80035
	116	80	40	3	0400F80040
	116	80	50	3	0400F80050

ART.	B	H	a	COD.
401 - P	80	30	5	0401P80305

ART.	B	H	a	COD.
402 - P	80	30	2	0402P80302

ART.	B	H	a	COD.
403 - P	80	30	3	0403P80303

### Ricambi / Spare parts / Rechanges / Repuestos / Ersatzteile

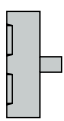

COD.  
04805128F0

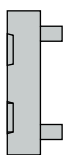

COD.  
04805138F0

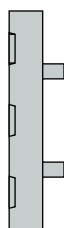

COD.  
04805158F0

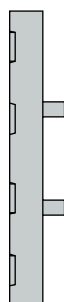

COD.  
04805178F0



COD.  
0480701020



COD.  
048073B000

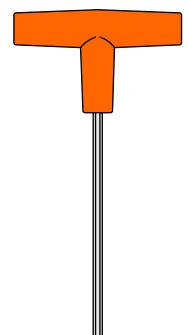

COD.  
048078L500

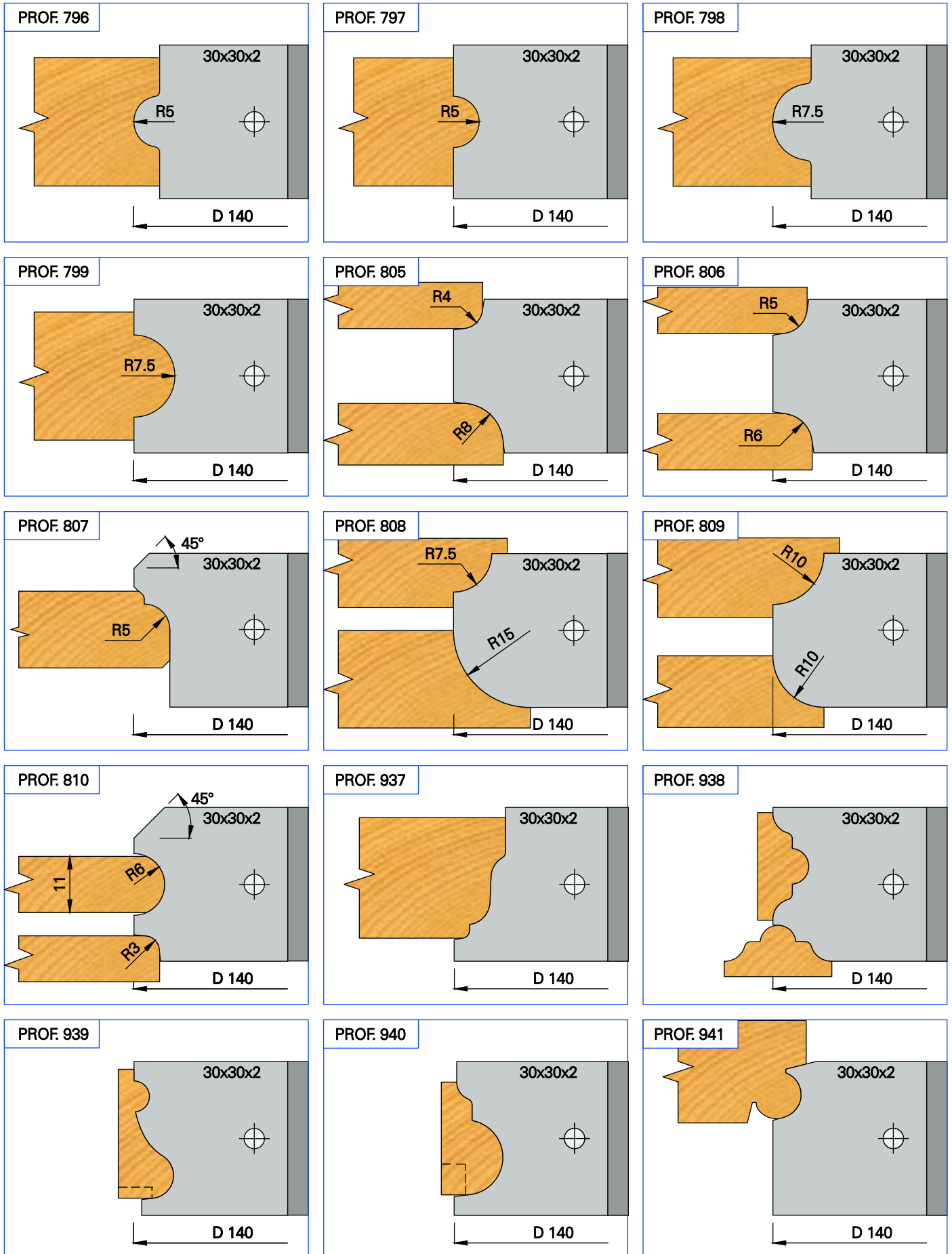



 Examples of workable profiles.

 Ejemplos de perfiles realizables.

 Exemples de profils réalisables.

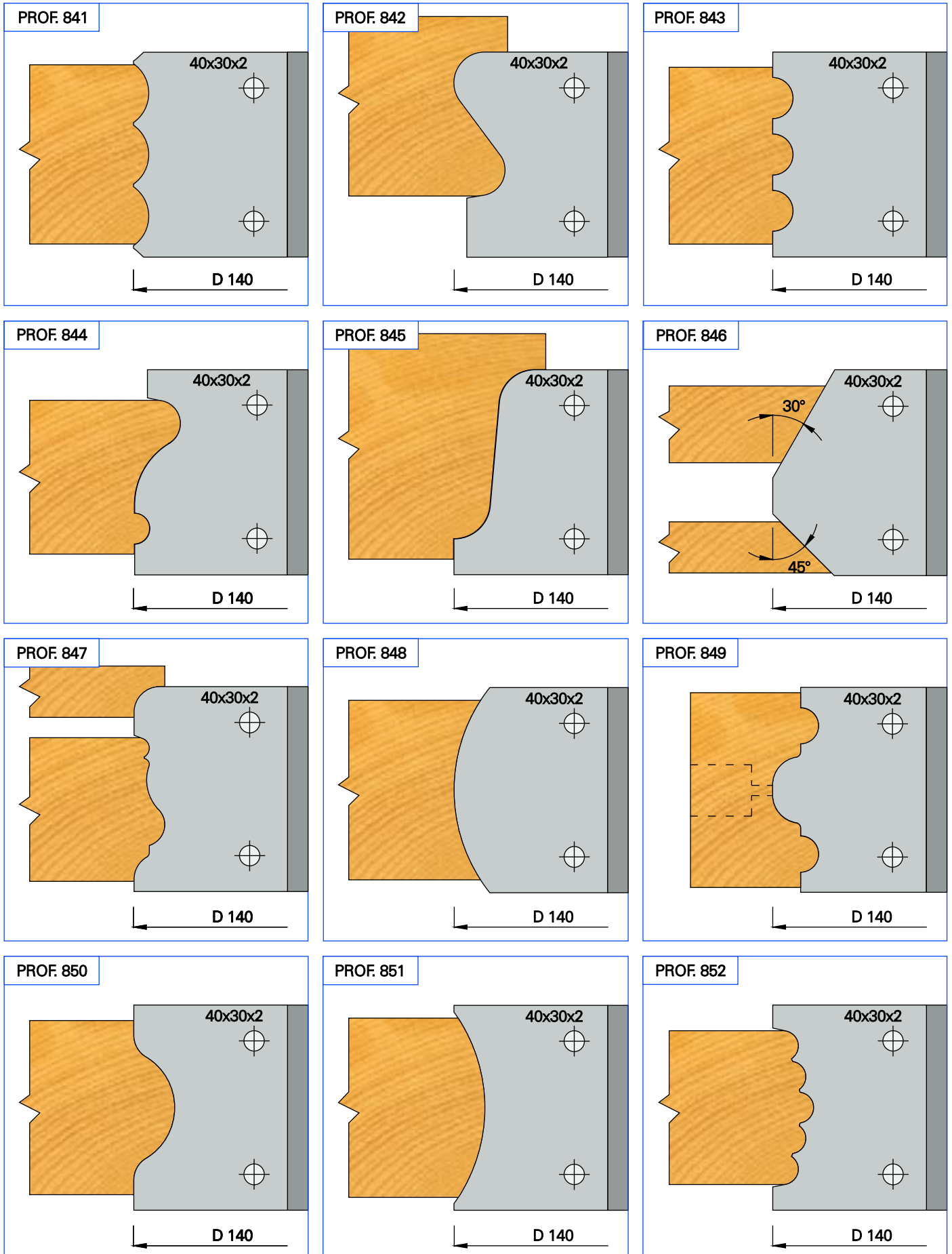
 Durchführbaren Profilbeispiele.



 Examples of workable profiles.

 Ejemplos de perfiles realizables.

 Exemples de profils réalisables.

 Durchführbaren Profilbeispiele.



PROF. 881

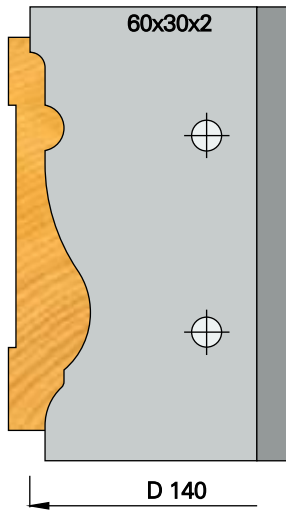

PROF. 882

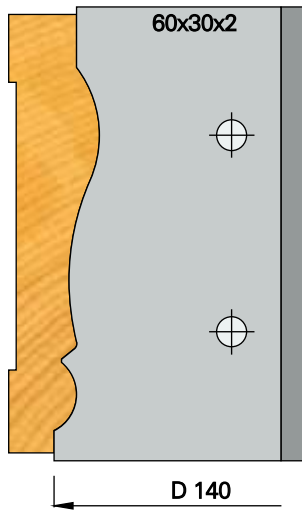

PROF. 883

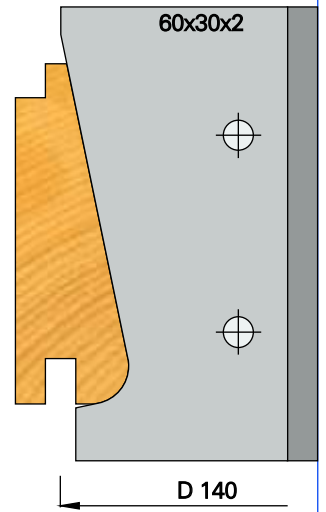

PROF. 884

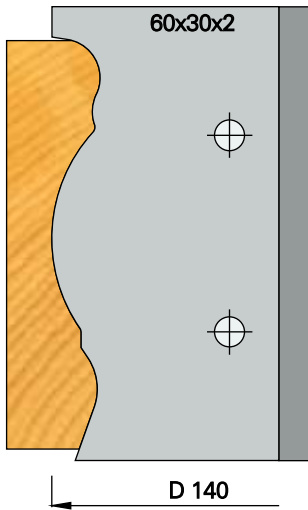

PROF. 885

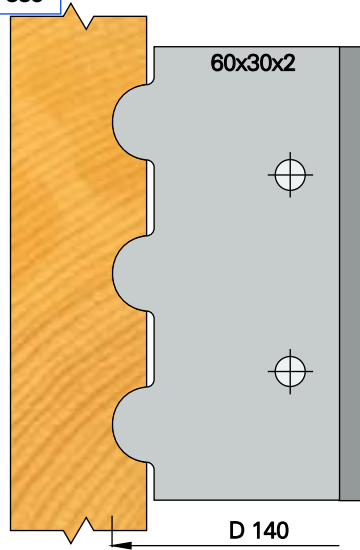

PROF. 886

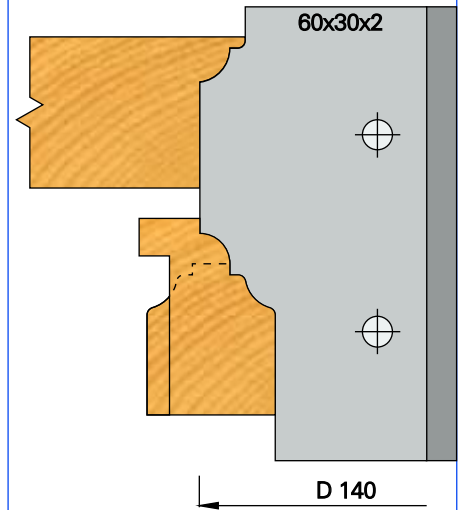

PROF. 944

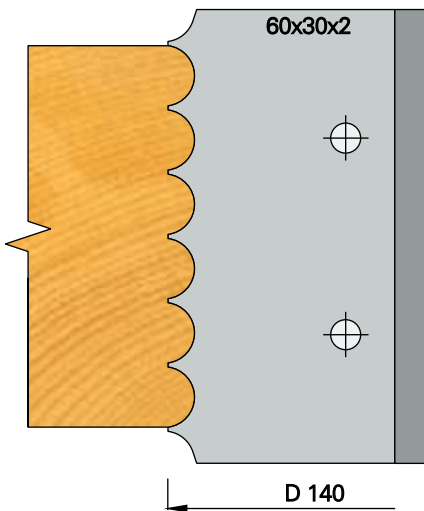

PROF. 945

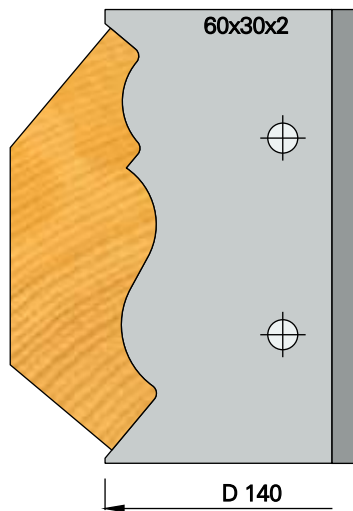

PROF. 946

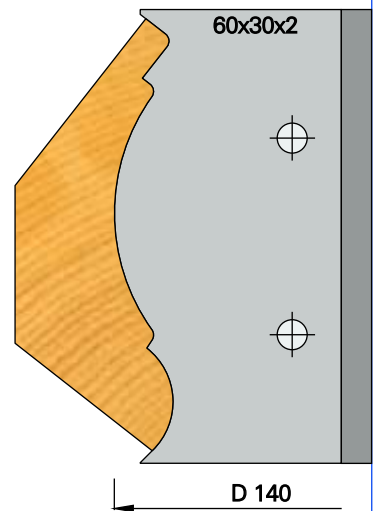

Examples of workable profiles.



Ejemplos de perfiles realizables.





Exemples de profils réalisables.

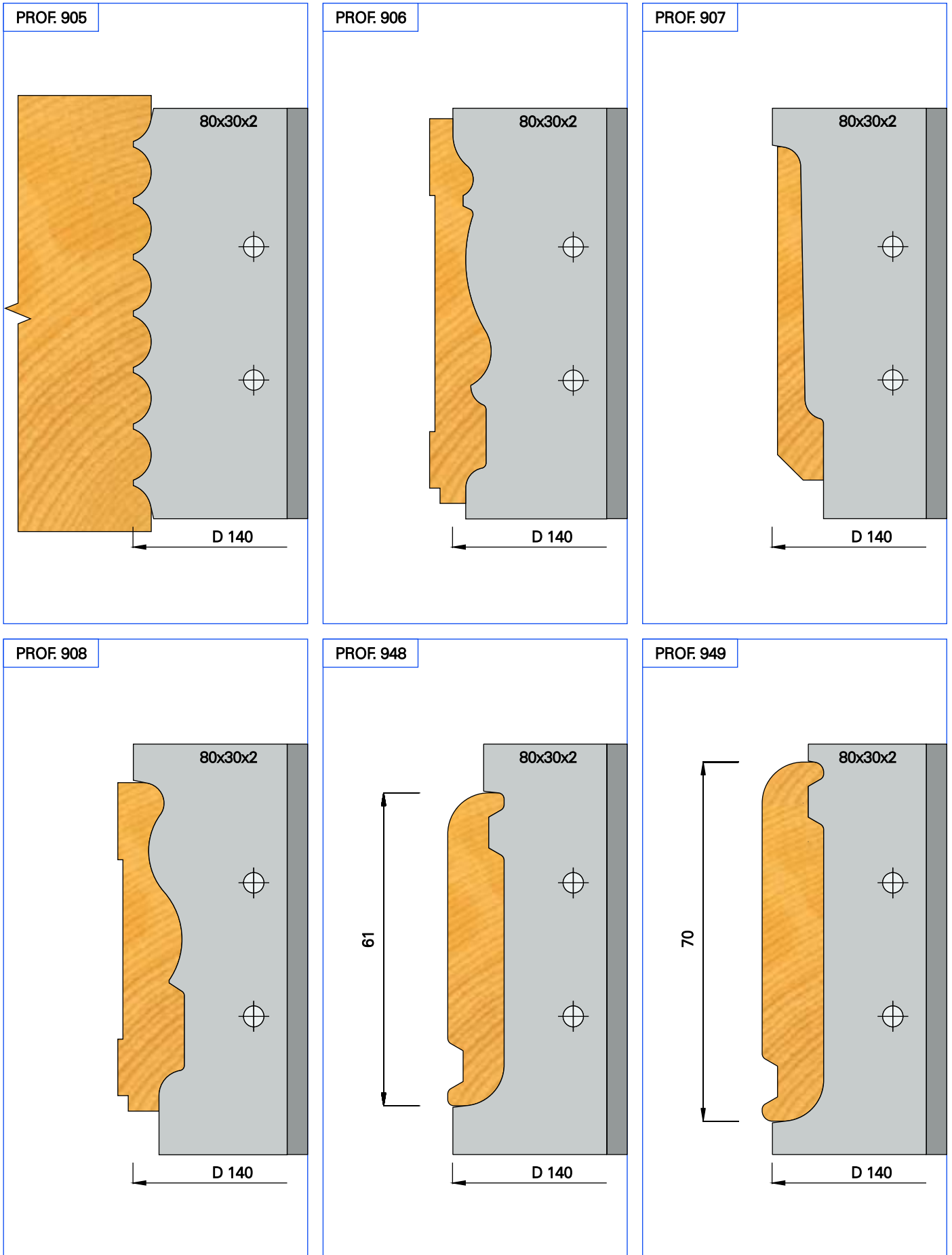

Durchführbaren Profilbeispiele.



 Examples of workable profiles.

 Ejemplos de perfiles realizables.

 Exemples de profils réalisables.

 Durchführbaren Profilbeispiele.



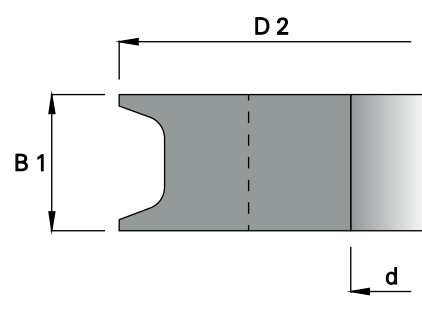

**HW**

**MEC**

n max 7000

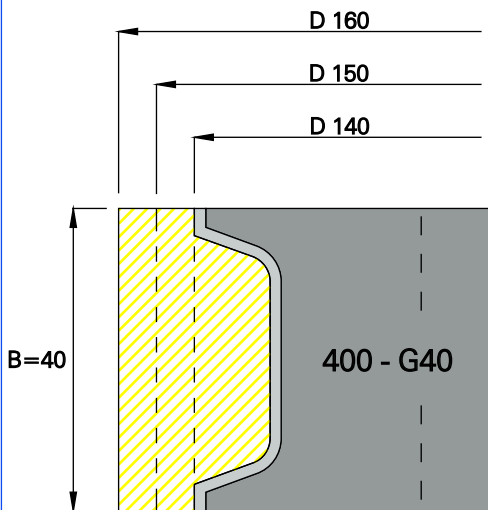
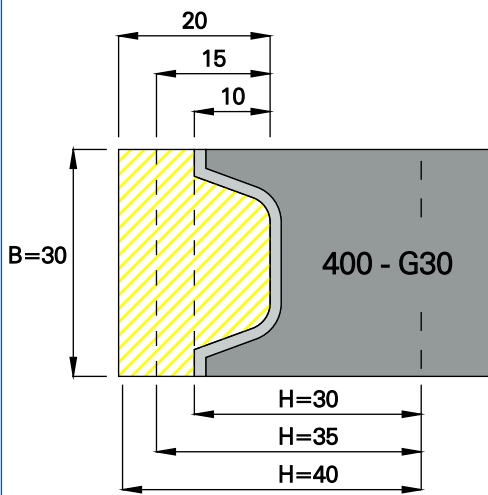

AREA PROFILABILE / PROFILING AREA

ART.	D 2	B 1	d	Z	COD.
400 - G30	137	30	30	3	0400G30030
	137	30	31.75	3	0400G30031
	137	30	35	3	0400G30035
	137	30	40	3	0400G30040
	137	30	50	3	0400G30050

ART.	B	H	a	COD.
401 - P	30	30	5	0401P30305
	30	35	5	0401P30355
	30	40	5	0401P30405

ART.	B	H	a	COD.
402 - P	30	30	2	0402P30302
	30	35	2	0402P30352
	30	40	2	0402P30402

ART.	B	H	a	COD.
403 - P	30	30	3	0403P30303
	30	35	3	0403P30353
	30	40	3	0403P30403

ART.	D 2	B 1	d	Z	COD.
400 - G40	137	40	30	3	0400G40030
	137	40	31.75	3	0400G40031
	137	40	35	3	0400G40035
	137	40	40	3	0400G40040
	137	40	50	3	0400G40050

ART.	B	H	a	COD.
401 - P	40	30	5	0401P40305
	40	35	5	0401P40355
	40	40	5	0401P40405

ART.	B	H	a	COD.
402 - P	40	30	2	0402P40302
	40	35	2	0402P40352
	40	40	2	0402P40402

ART.	B	H	a	COD.
403 - P	40	30	3	0403P40303
	40	35	3	0403P40353
	40	40	3	0403P40403



Multi - profiles cutter heads.



Cabezales multiperfiles.



Porte - outils multiprofiles.



Multiprofil - Messerköpfe.

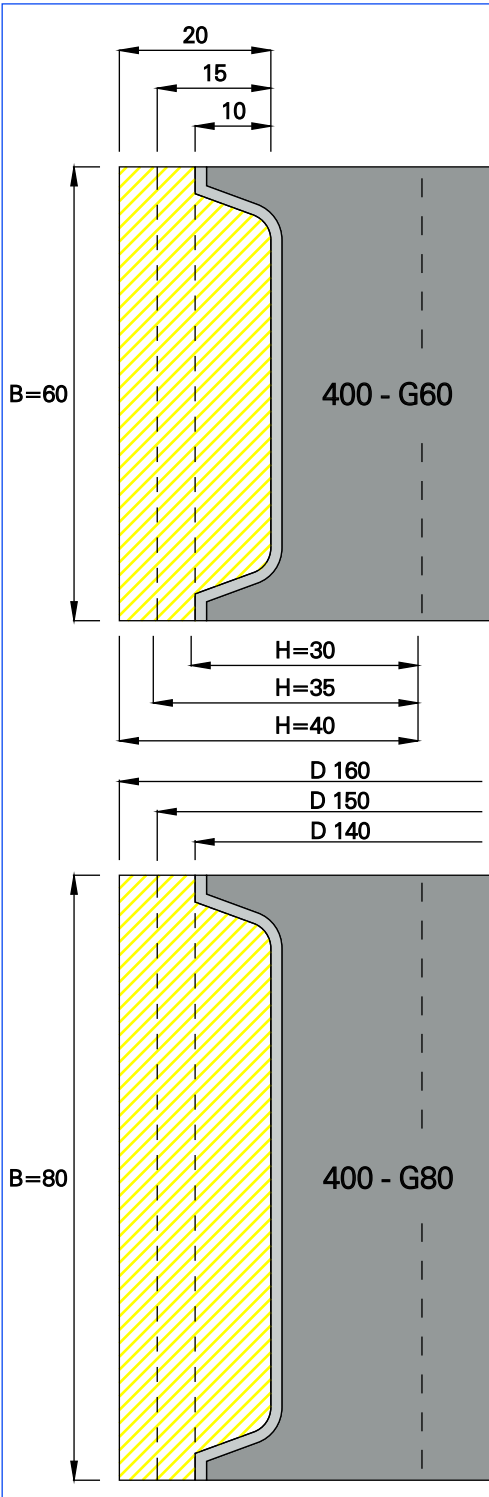

ART.	D 2	B 1	d	Z	COD.
400 - G60	137	60	30	3	0400G60030
	137	60	31.75	3	0400G60031
	137	60	35	3	0400G60035
	137	60	40	3	0400G60040
	137	60	50	3	0400G60050

ART.	B	H	a	COD.
401 - P	60	30	5	0401P60305
	60	35	5	0401P60355
	60	40	5	0401P60405

ART.	B	H	a	COD.
402 - P	60	30	2	0402P60302
	60	35	2	0402P60352
	60	40	2	0402P60402

ART.	B	H	a	COD.
403 - P	60	30	3	0403P60303
	60	35	3	0403P60353
	60	40	3	0403P60403

ART.	D 2	B 1	d	Z	COD.
400 - G80	137	80	30	3	0400G80030
	137	80	31.75	3	0400G80031
	137	80	35	3	0400G80035
	137	80	40	3	0400G80040
	137	80	50	3	0400G80050

ART.	B	H	a	COD.
401 - P	80	30	5	0401P80305
	80	35	5	0401P80355
	80	40	5	0401P80405

ART.	B	H	a	COD.
402 - P	80	30	2	0402P80302
	80	35	2	0402P80352
	80	40	2	0402P80402

ART.	B	H	a	COD.
403 - P	80	30	3	0403P80303
	80	35	3	0403P80353
	80	40	3	0403P80403

### Ricambi / Spare parts / Rechanges / Repuestos / Ersatzteile

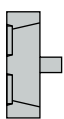

COD.  
04805128G0

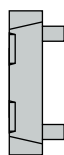

COD.  
04805138G0

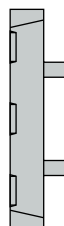

COD.  
04805158G0

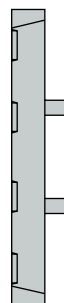

COD.  
04805178G0



COD.  
0480701020



COD.  
048073B000

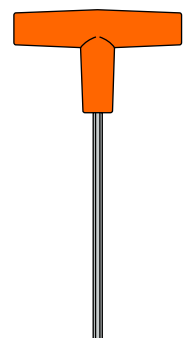

COD.  
048078L500

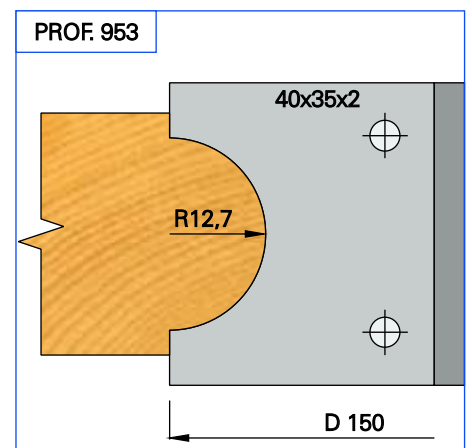
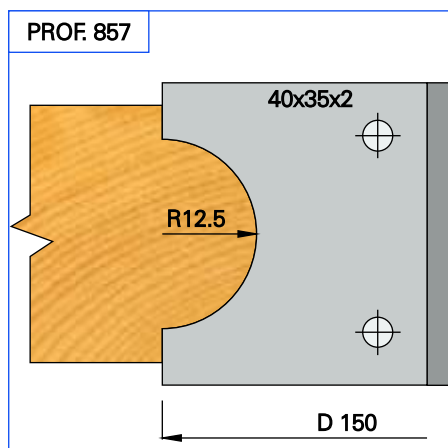
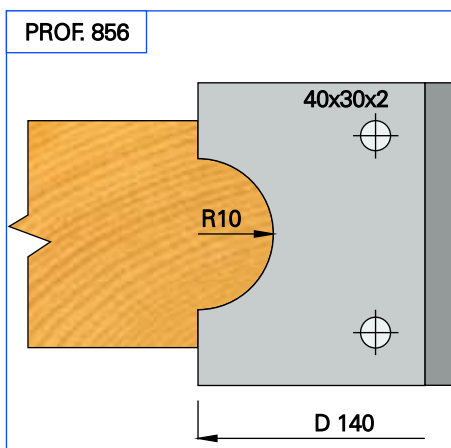
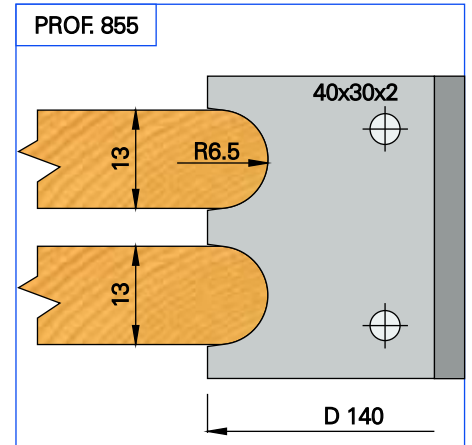
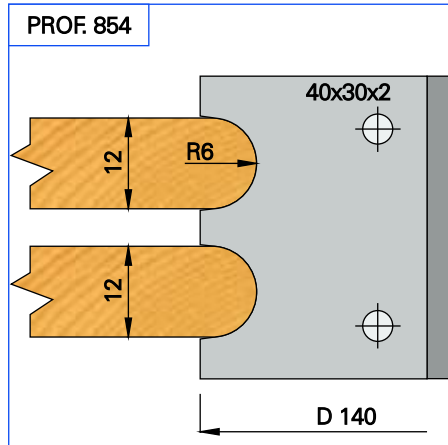
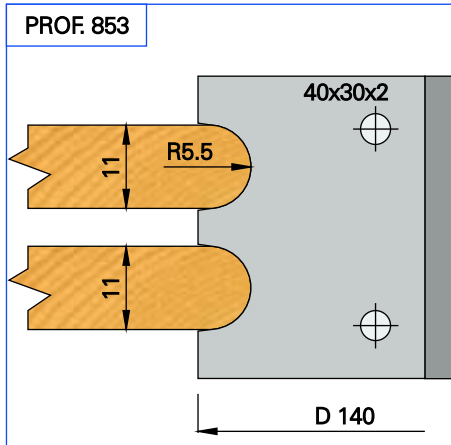
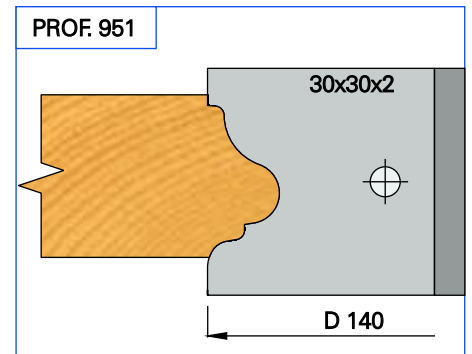
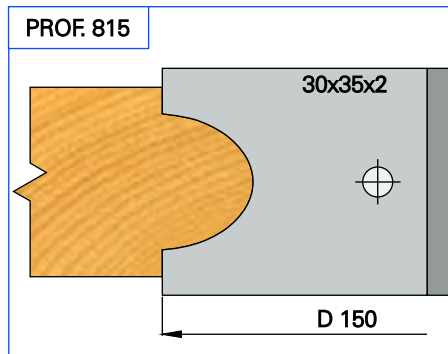
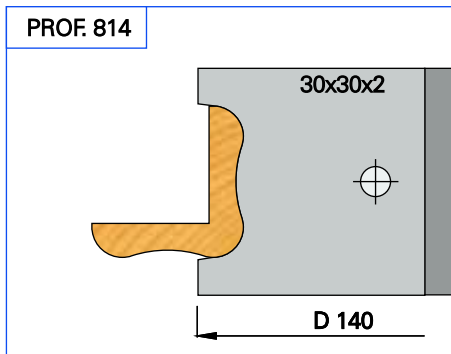
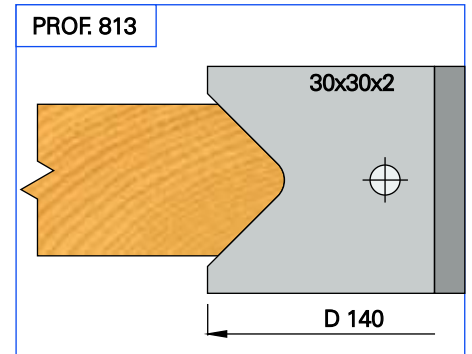
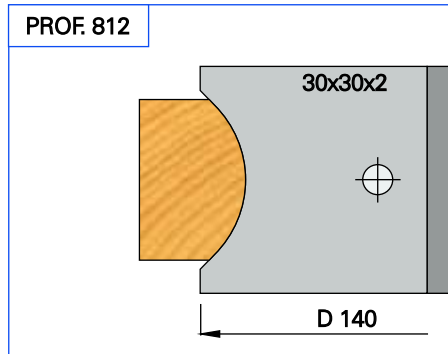
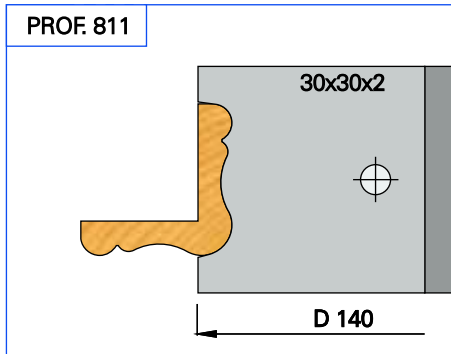



Examples of workable profiles.

Ejemplos de perfiles realizables.

Exemples de profils réalisables.

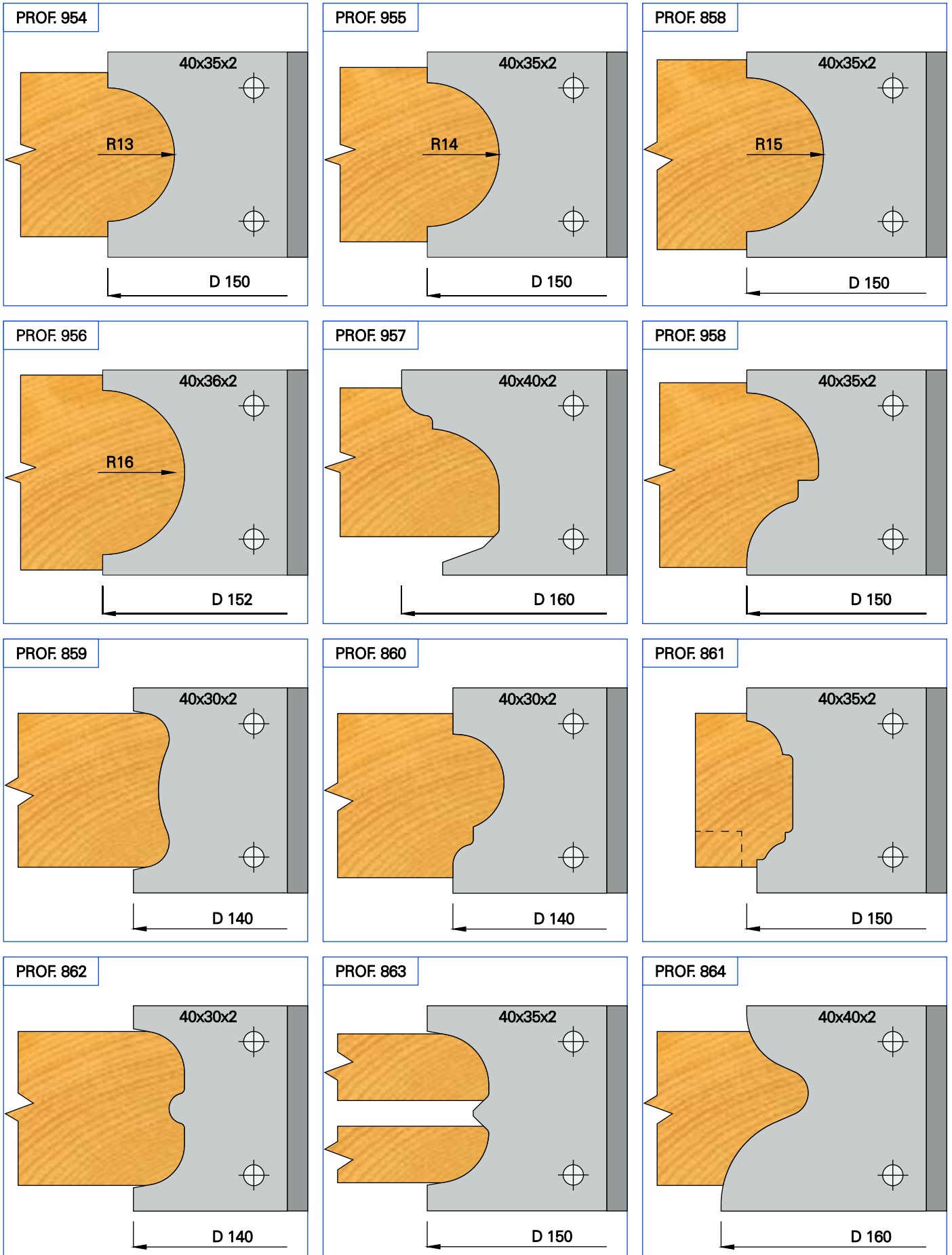
Durchführbaren Profilbeispiele.



 Examples of workable profiles.

 Ejemplos de perfiles realizables.

 Exemples de profils réalisables.

 Durchführbaren Profilbeispiele.



PROF. 887

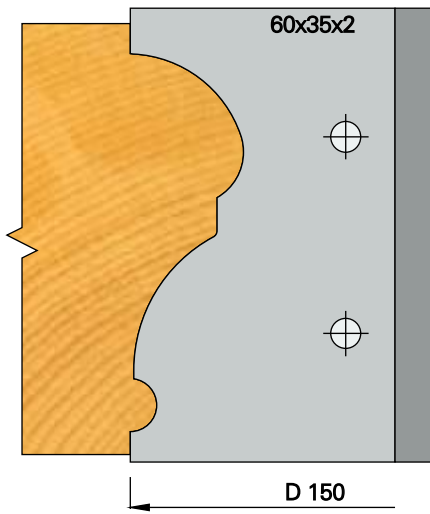

PROF. 888

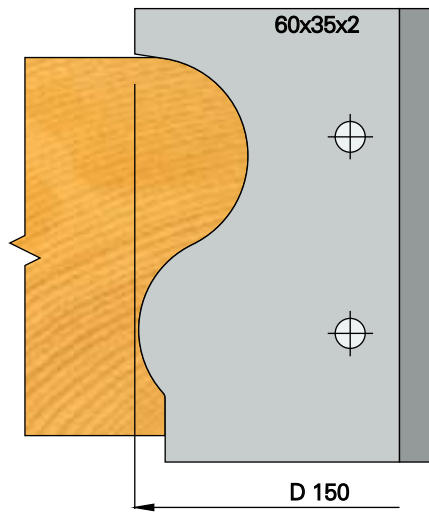

PROF. 889

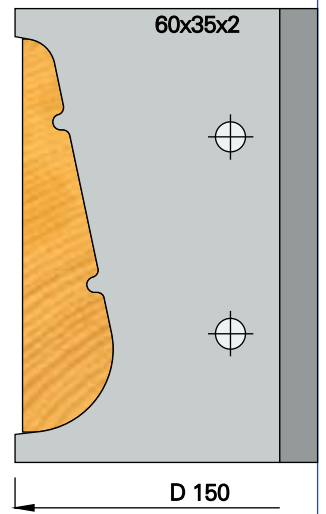

PROF. 890

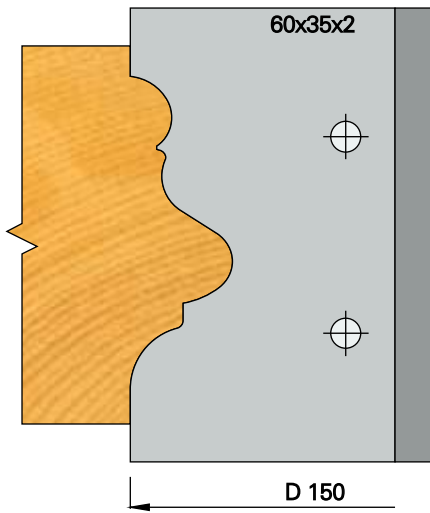

PROF. 891

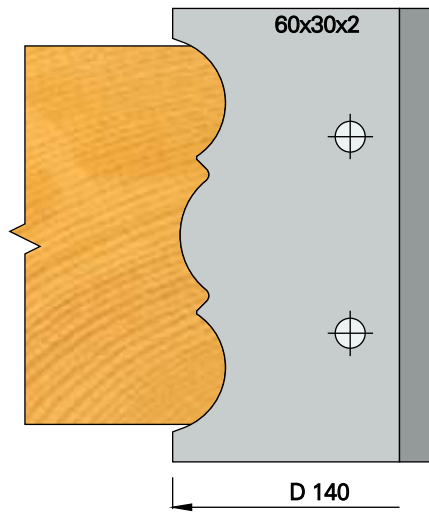

PROF. 892

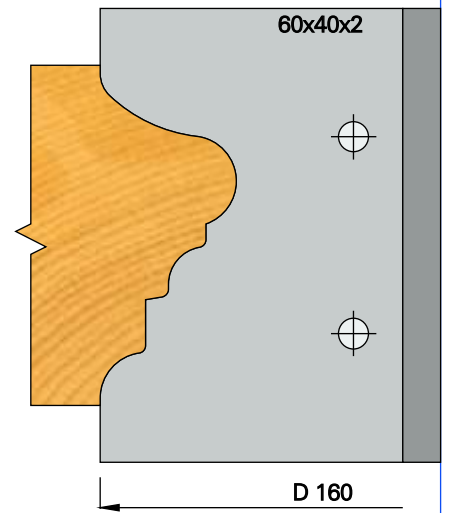

PROF. 960

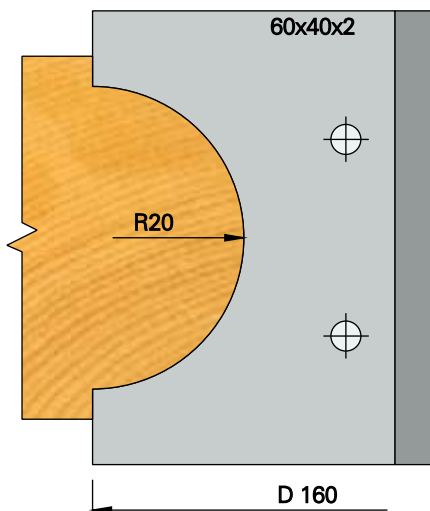

PROF. 961

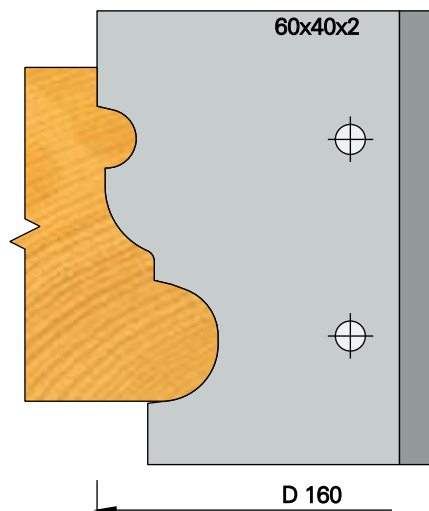

PROF. 962

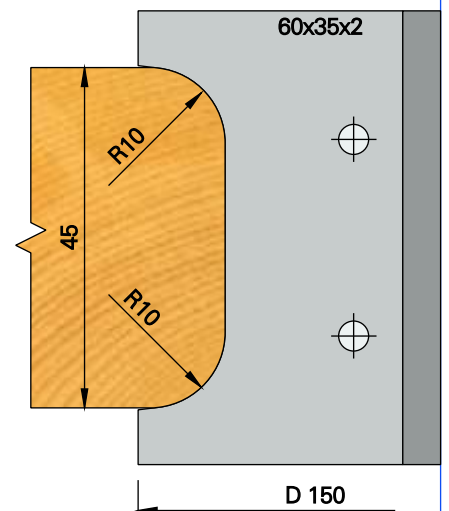



 Examples of workable profiles.

 Ejemplos de perfiles realizables.

 Exemples de profils réalisables.

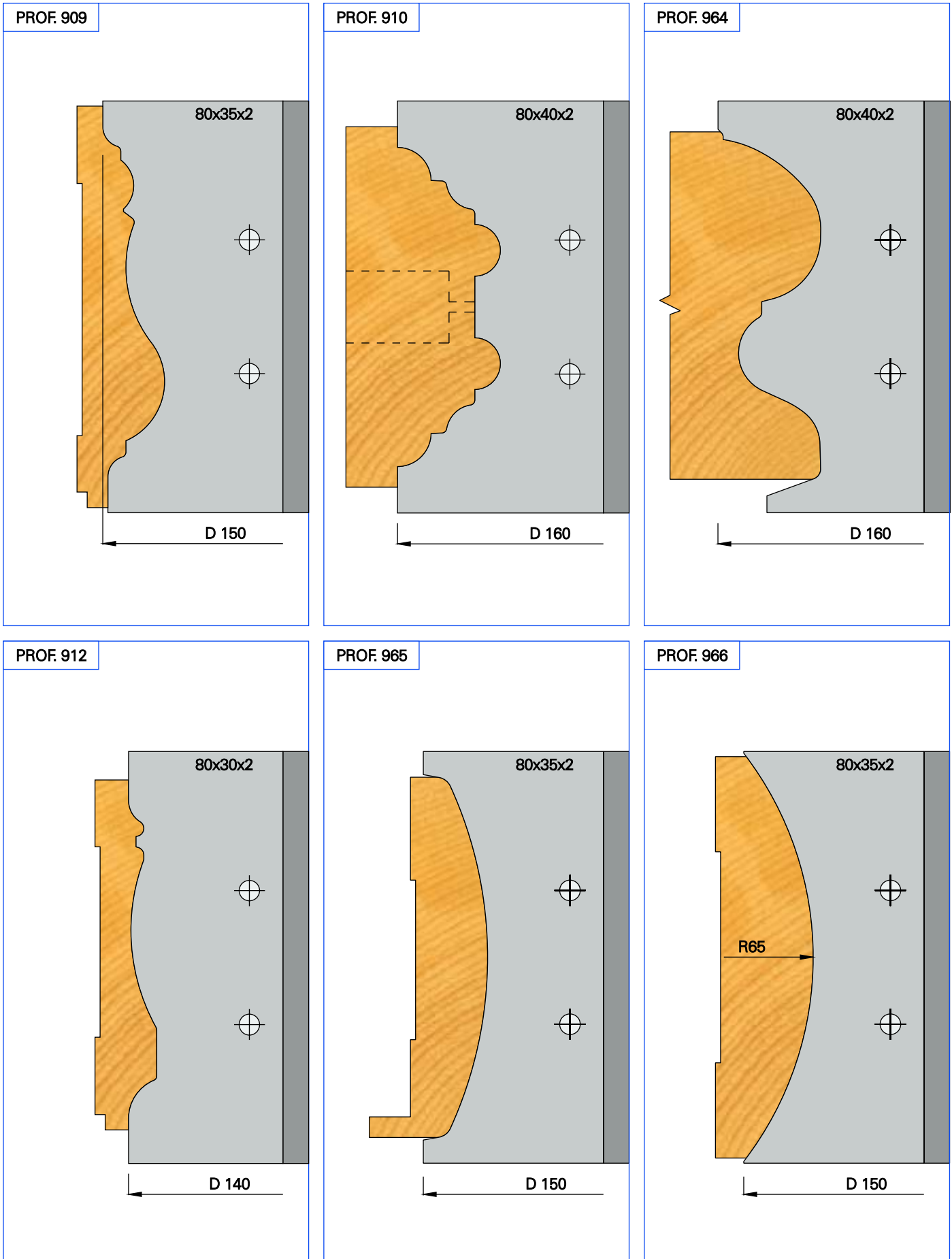
 Durchführbaren Profilbeispiele.



 Examples of workable profiles.

 Ejemplos de perfiles realizables.

 Exemples de profils réalisables.

 Durchführbaren Profilbeispiele.

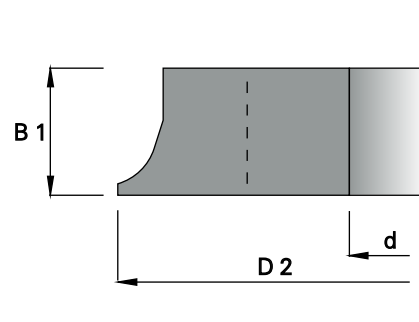

**HW**

**MEC**

n max 7000

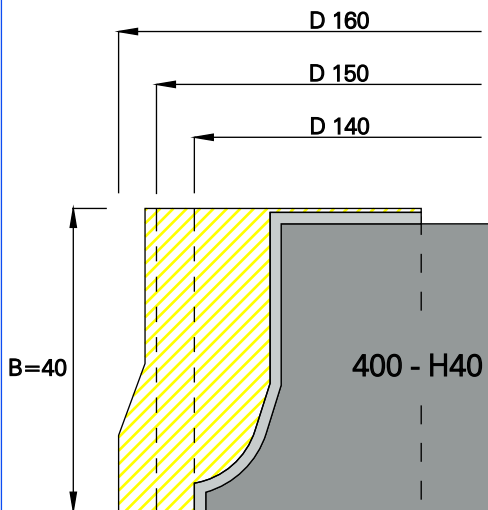
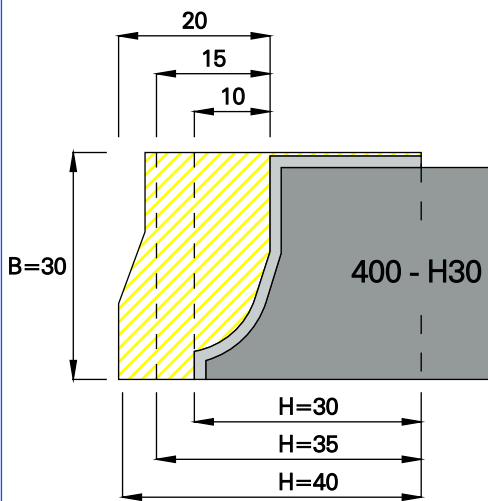

AREA PROFILABILE / PROFILING AREA

ART.	D 2	B 1	d	Z	COD.
400 - H30	137	28	30	3	0400H30030
	137	28	31.75	3	0400H30031
	137	28	35	3	0400H30035
	137	28	40	3	0400H30040
	137	28	50	3	0400H30050

ART.	B	H	a	COD.
401 - P	30	30	5	0401P30305
	30	35	5	0401P30355
	30	40	5	0401P30405

ART.	B	H	a	COD.
402 - P	30	30	2	0402P30302
	30	35	2	0402P30352
	30	40	2	0402P30402

ART.	B	H	a	COD.
403 - P	30	30	3	0403P30303
	30	35	3	0403P30353
	30	40	3	0403P30403

ART.	D 2	B 1	d	Z	COD.
400 - H40	137	38	30	3	0400H40030
	137	38	31.75	3	0400H40031
	137	38	35	3	0400H40035
	137	38	40	3	0400H40040
	137	38	50	3	0400H40050

ART.	B	H	a	COD.
401 - P	40	30	5	0401P40305
	40	35	5	0401P40355
	40	40	5	0401P40405

ART.	B	H	a	COD.
402 - P	40	30	2	0402P40302
	40	35	2	0402P40352
	40	40	2	0402P40402

ART.	B	H	a	COD.
403 - P	40	30	3	0403P40303
	40	35	3	0403P40353
	40	40	3	0403P40403



Multi - profiles cutter heads.



Cabezales multiperfiles.



Porte - outils multiprofiles.



Multiprofil - Messerköpfe.

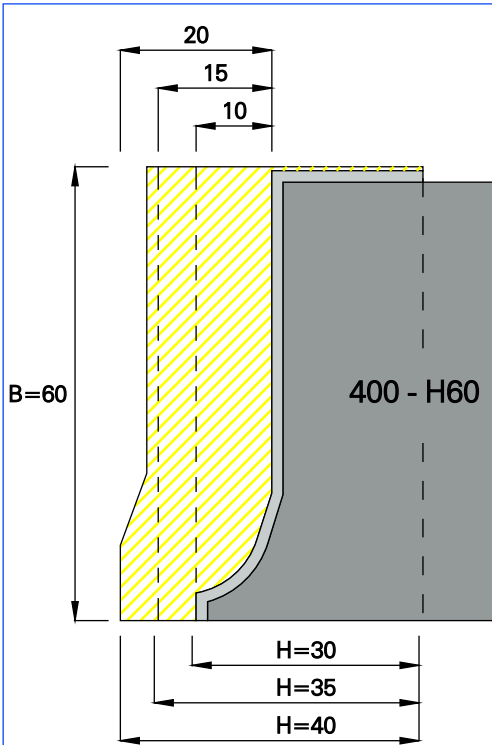

ART.	D 2	B 1	d	Z	COD.
400 - H60	137	58	30	3	0400H60030
	137	58	31.75	3	0400H60031
	137	58	35	3	0400H60035
	137	58	40	3	0400H60040
	137	58	50	3	0400H60050

ART.	B	H	a	COD.
401 - P	60	30	5	0401P60305
	60	35	5	0401P60355
	60	40	5	0401P60405

ART.	B	H	a	COD.
402 - P	60	30	2	0402P60302
	60	35	2	0402P60352
	60	40	2	0402P60402

ART.	B	H	a	COD.
403 - P	60	30	3	0403P60303
	60	35	3	0403P60353
	60	40	3	0403P60403

### Ricambi / Spare parts / Rechanges / Repuestos / Ersatzteile

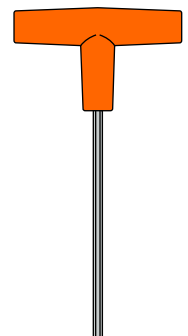
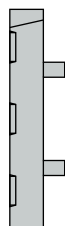
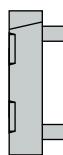
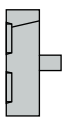

COD.  
04805128H0

COD.  
04805138H0

COD.  
04805158H0

COD.  
0480701020

COD.  
048073B000

COD.  
048078L500



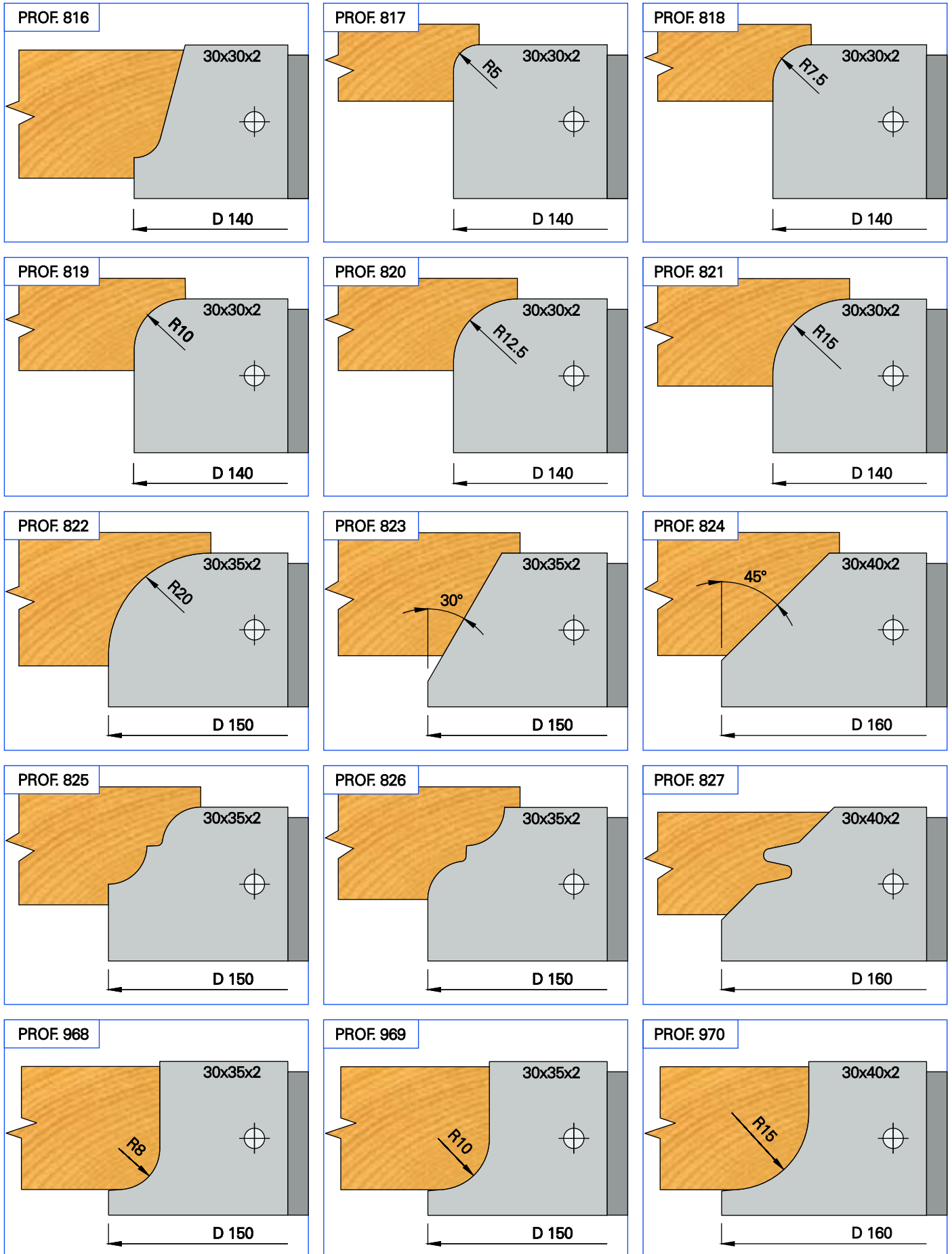



 Examples of workable profiles.

 Ejemplos de perfiles realizables.

 Exemples de profils réalisables.

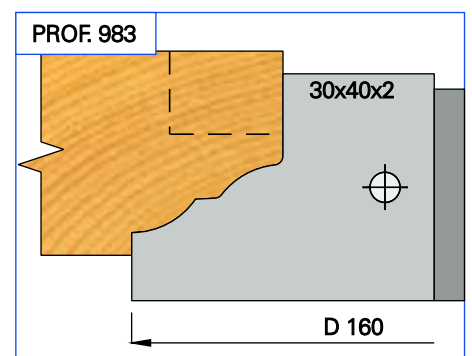
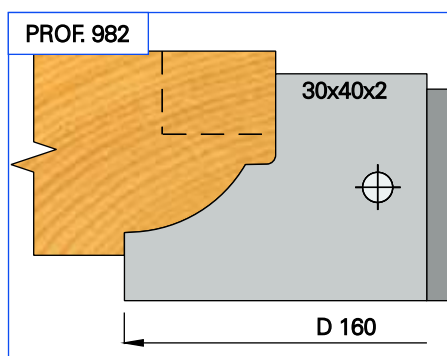
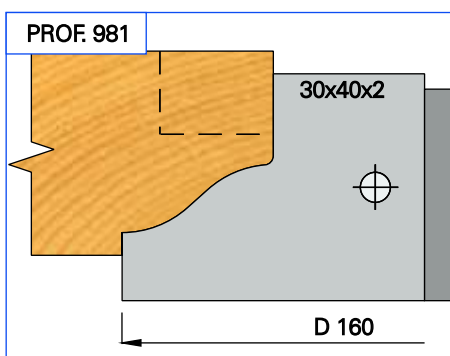
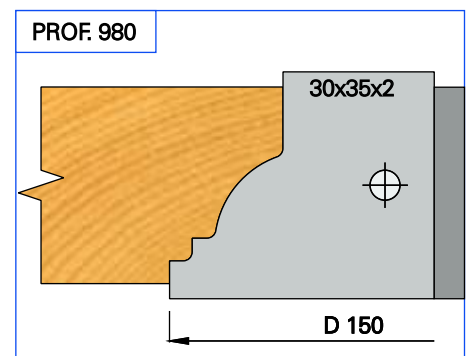
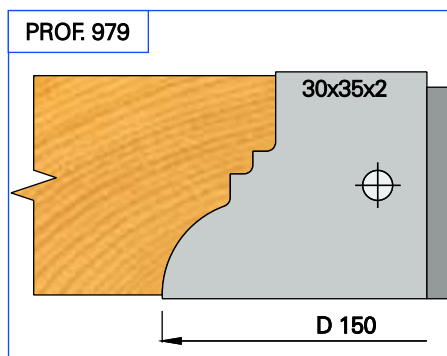
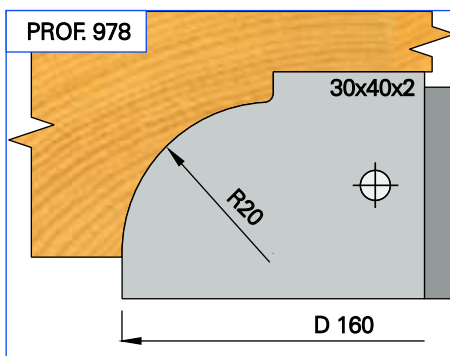
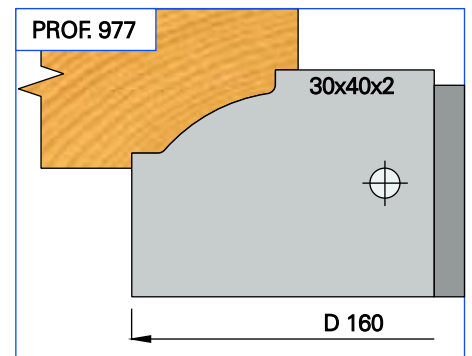
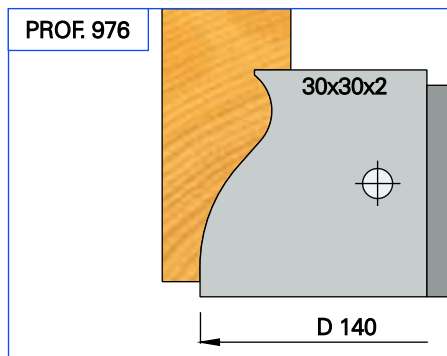
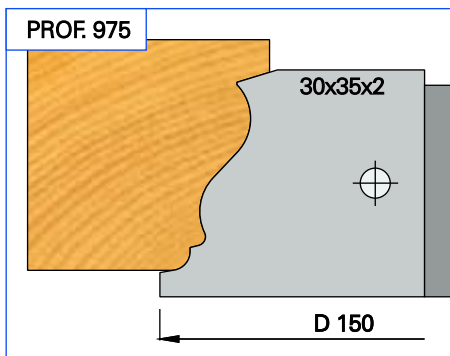
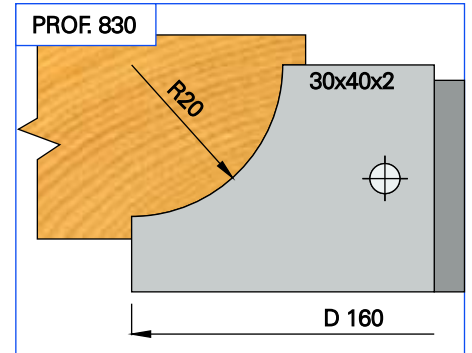
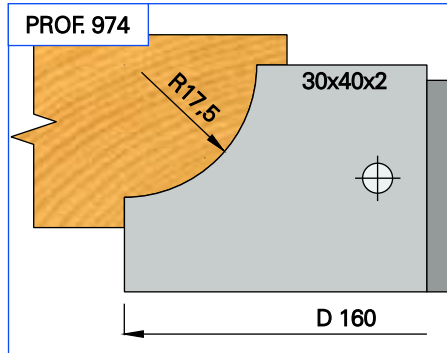
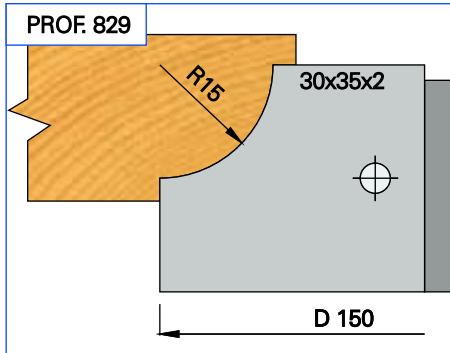
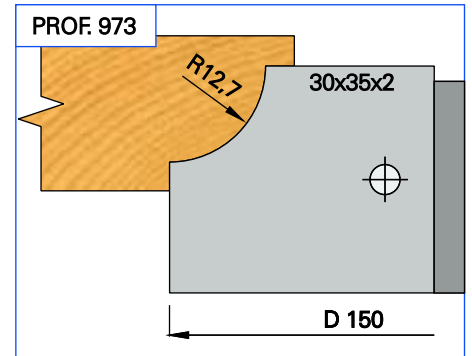
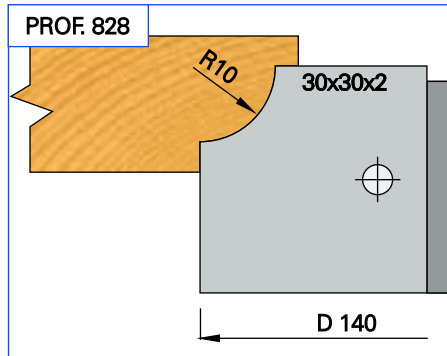
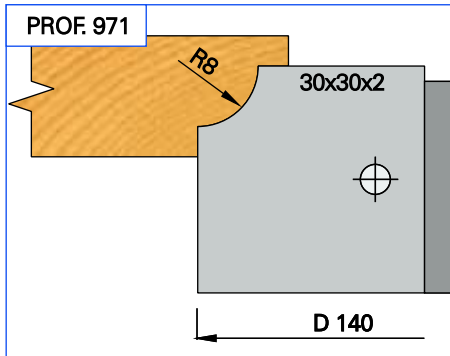
 Durchführbaren Profilbeispiele.





 Examples of workable profiles.

 Ejemplos de perfiles realizables.

 Exemples de profils réalisables.

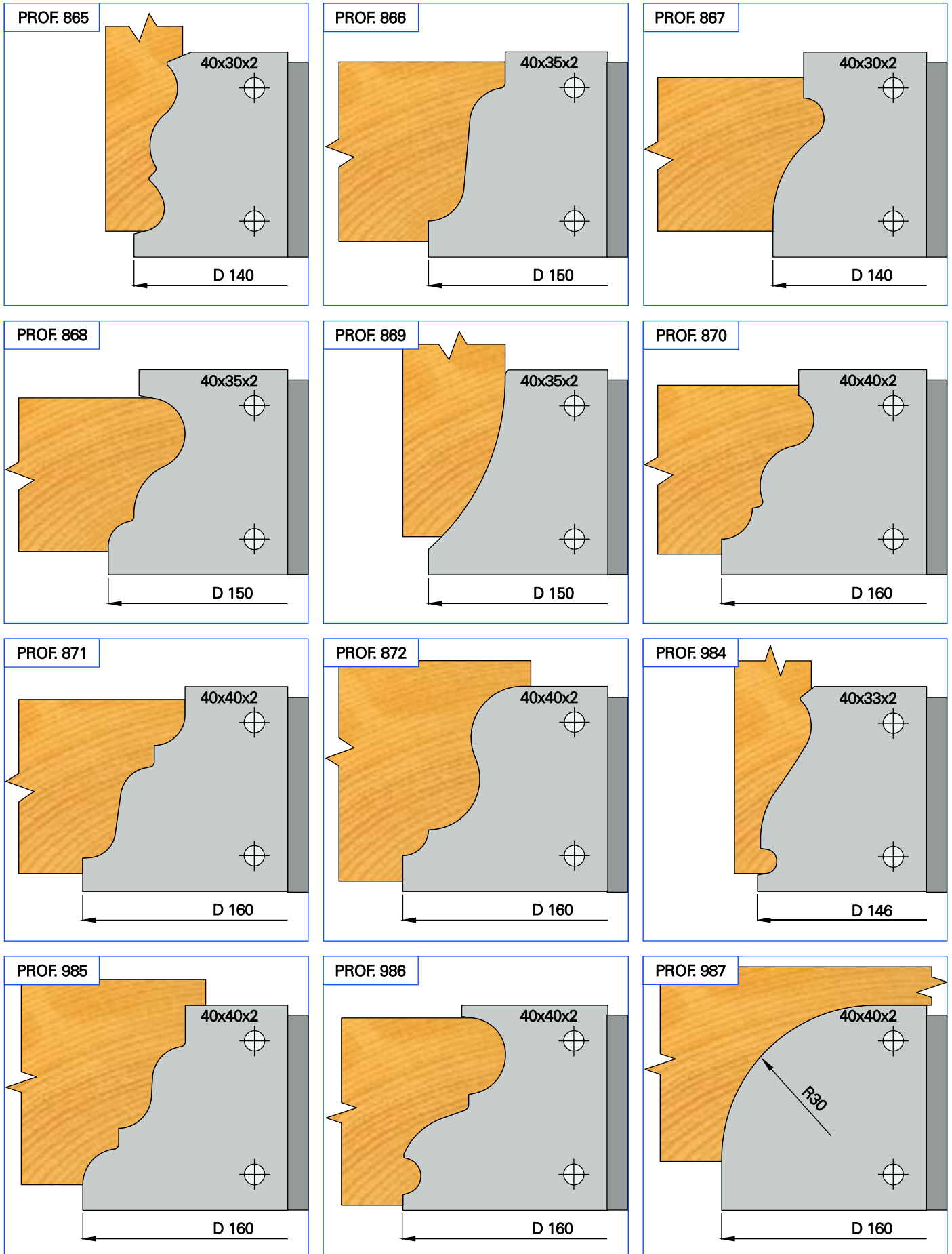
 Durchführbaren Profilbeispiele.





 Examples of workable profiles.

 Ejemplos de perfiles realizables.

 Exemples de profils réalisables.

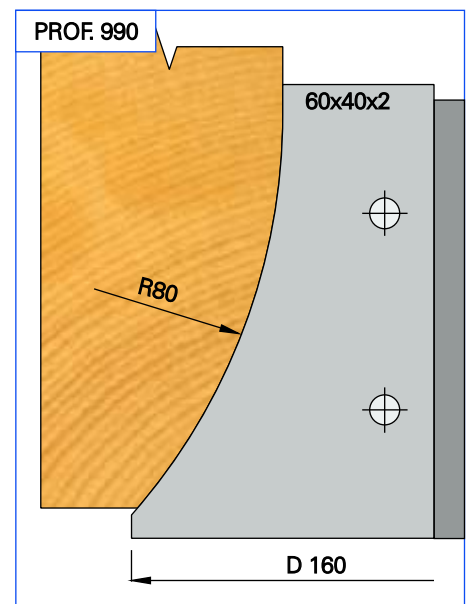
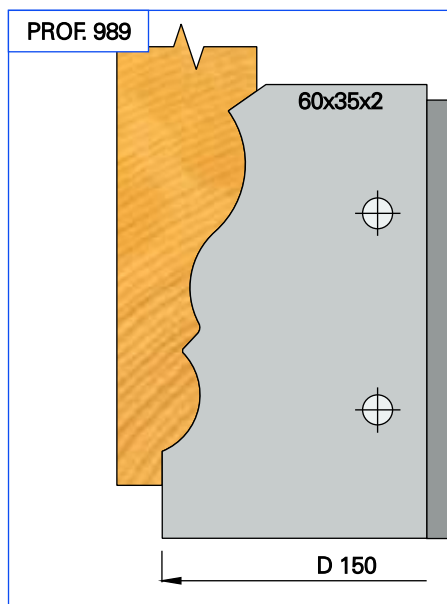
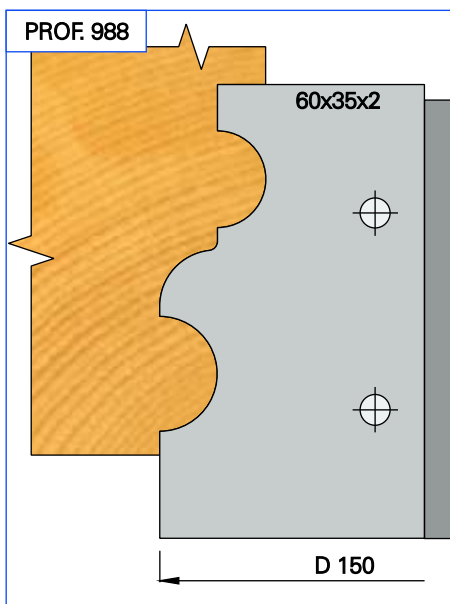
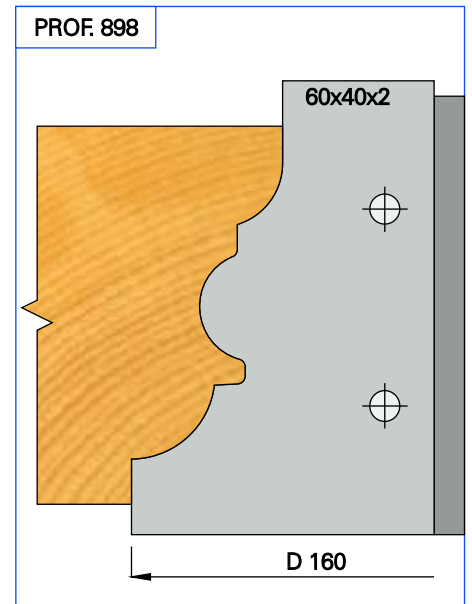
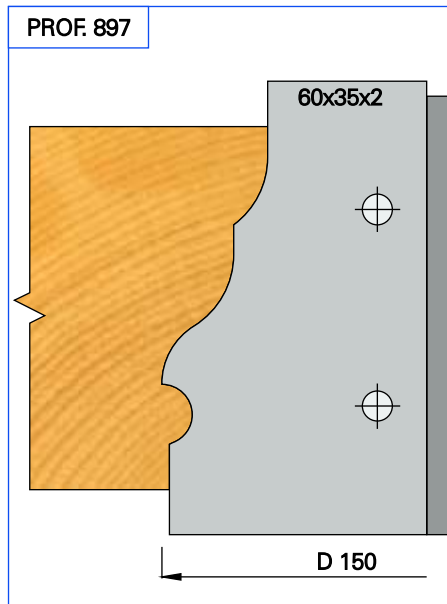
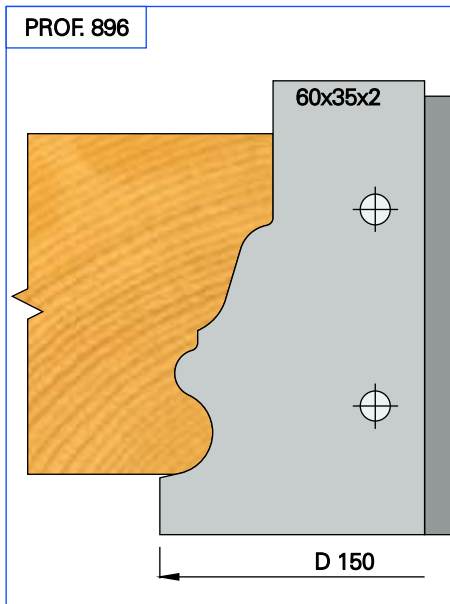
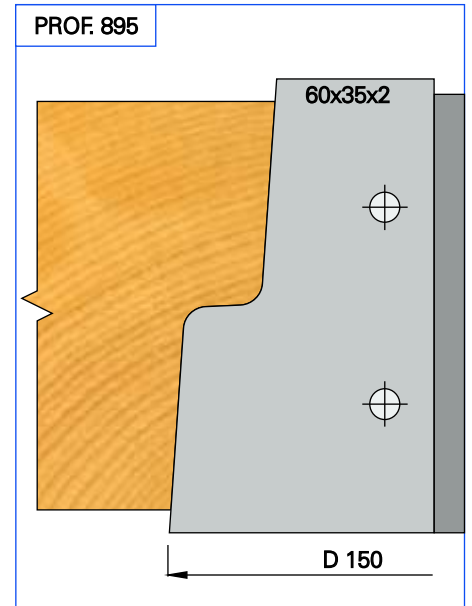
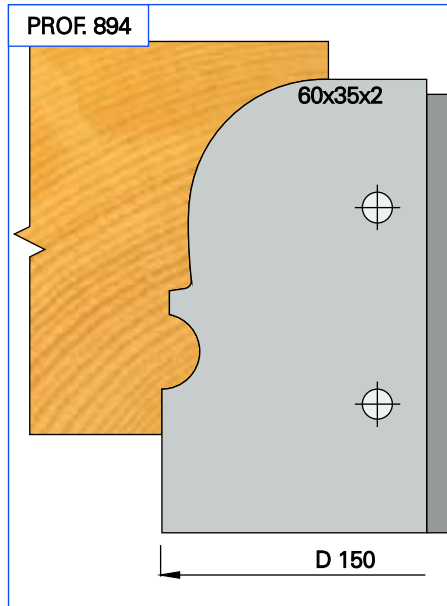
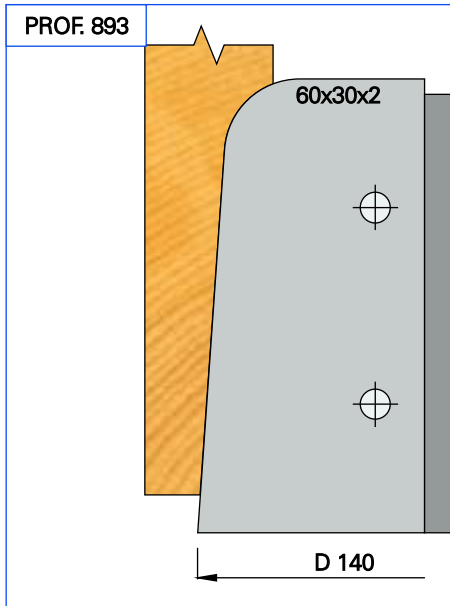
 Durchführbaren Profilbeispiele.



 Examples of workable profiles.

 Ejemplos de perfiles realizables.

 Exemples de profils réalisables.

 Durchführbaren Profilbeispiele.

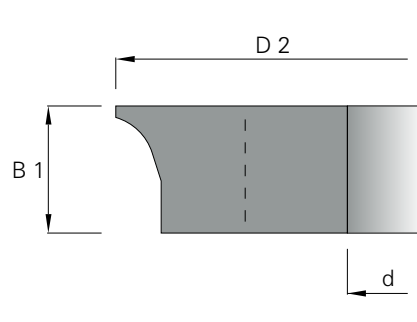

**HW**

**MEC**

n max 7000

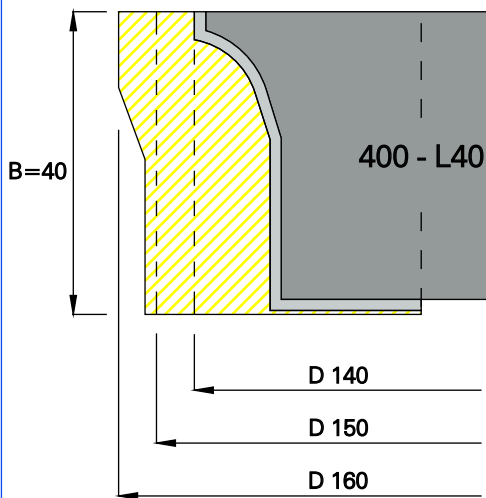
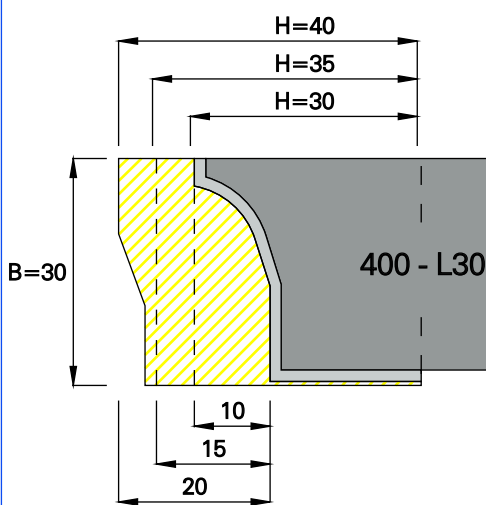

AREA PROFILABILE / PROFILING AREA

ART.	D 2	B 1	d	Z	COD.
400 - L30	137	28	30	3	0400L30030
	137	28	31.75	3	0400L30031
	137	28	35	3	0400L30035
	137	28	40	3	0400L30040
	137	28	50	3	0400L30050

ART.	B	H	a	COD.
401 - P	30	30	5	0401P30305
	30	35	5	0401P30355
	30	40	5	0401P30405

ART.	B	H	a	COD.
402 - P	30	30	2	0402P30302
	30	35	2	0402P30352
	30	40	2	0402P30402

ART.	B	H	a	COD.
403 - P	30	30	3	0403P30303
	30	35	3	0403P30353
	30	40	3	0403P30403

ART.	D 2	B 1	d	Z	COD.
400 - L40	137	38	30	3	0400L40030
	137	38	31.75	3	0400L40031
	137	38	35	3	0400L40035
	137	38	40	3	0400L40040
	137	38	50	3	0400L40050

ART.	B	H	a	COD.
401 - P	40	30	5	0401P40305
	40	35	5	0401P40355
	40	40	5	0401P40405

ART.	B	H	a	COD.
402 - P	40	30	2	0402P40302
	40	35	2	0402P40352
	40	40	2	0402P40402

ART.	B	H	a	COD.
403 - P	40	30	3	0403P40303
	40	35	3	0403P40353
	40	40	3	0403P40403



Multi - profiles cutter heads.



Cabezales multiperfiles.



Porte - outils multiprofiles.



Multiprofil - Messerköpfe.

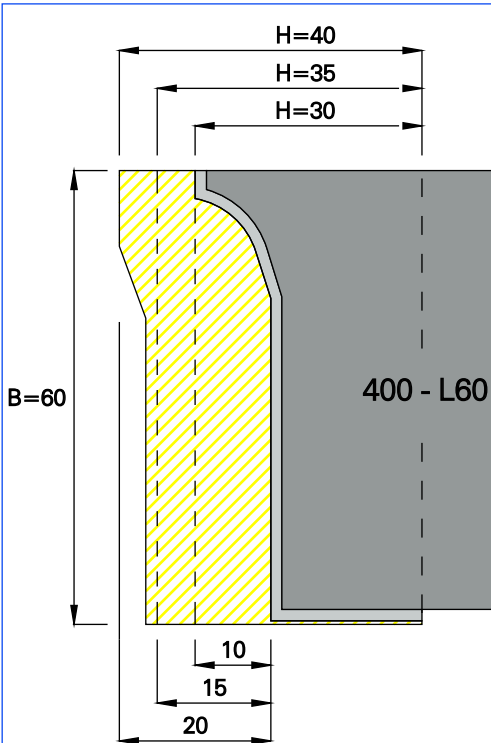

ART.	D 2	B 1	d	Z	COD.
400 - L60	137	58	30	3	0400L60030
	137	58	31.75	3	0400L60031
	137	58	35	3	0400L60035
	137	58	40	3	0400L60040
	137	58	50	3	0400L60050

ART.	B	H	a	COD.
401 - P	60	30	5	0401P60305
	60	35	5	0401P60355
	60	40	5	0401P60405

ART.	B	H	a	COD.
402 - P	60	30	2	0402P60302
	60	35	2	0402P60352
	60	40	2	0402P60402

ART.	B	H	a	COD.
403 - P	60	30	3	0403P60303
	60	35	3	0403P60353
	60	40	3	0403P60403

### Ricambi / Spare parts / Rechanges / Repuestos / Ersatzteile

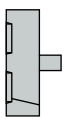

COD.  
04805128L0

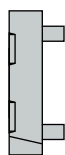

COD.  
04805138L0

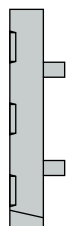

COD.  
04805158L0



COD.  
0480701020



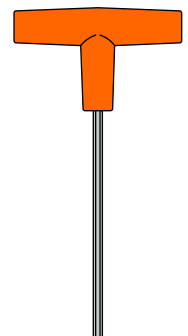

COD.  
048073B000

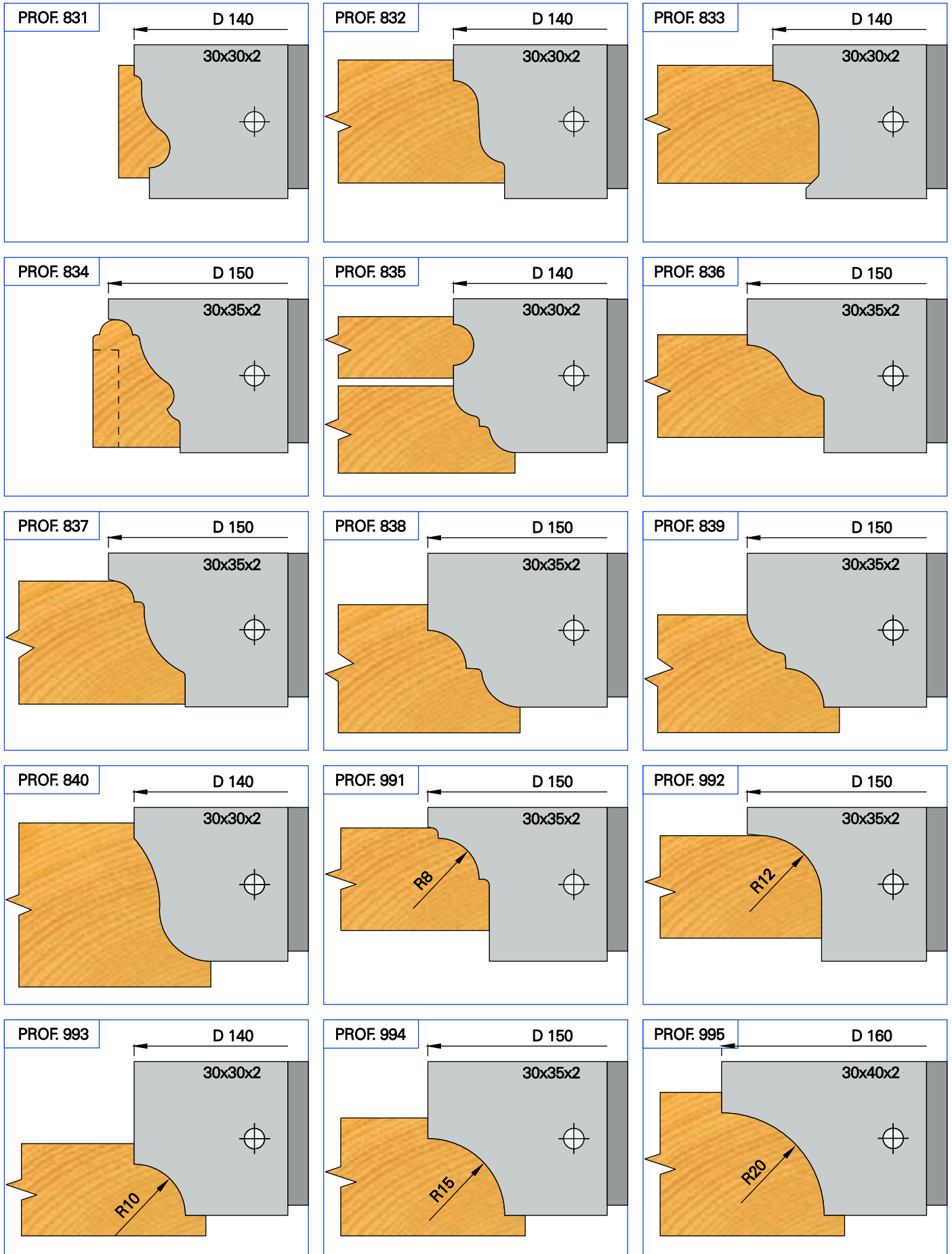

COD.  
048078L500



 Examples of workable profiles.

 Ejemplos de perfiles realizables.

 Exemples de profils réalisables.

 Durchführbaren Profilbeispiele.

# 400 - L40

## Esempi di lavorazione

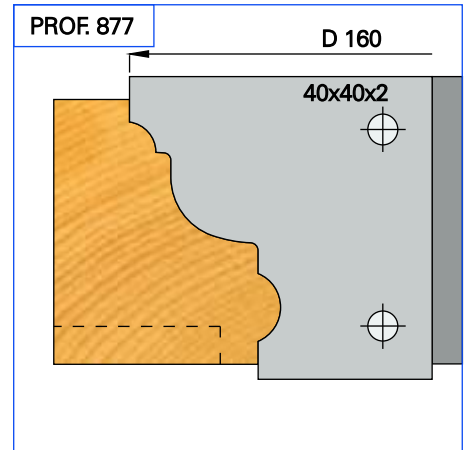
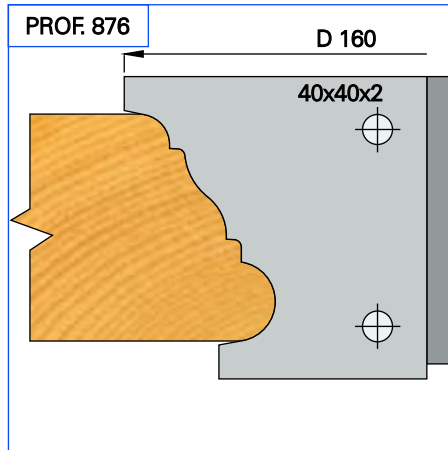
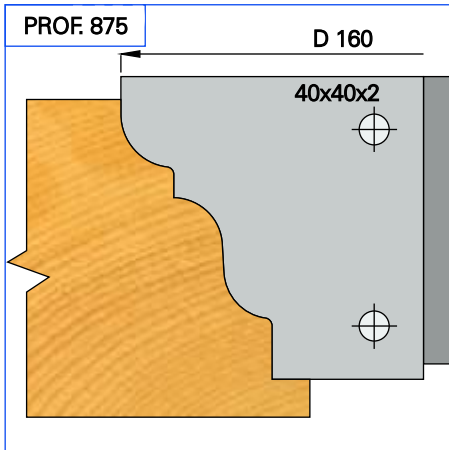

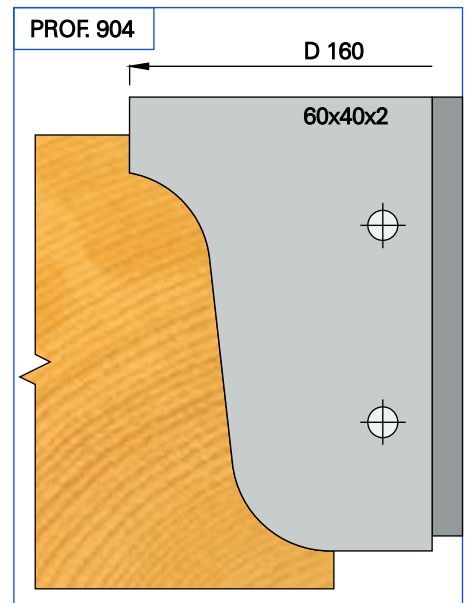
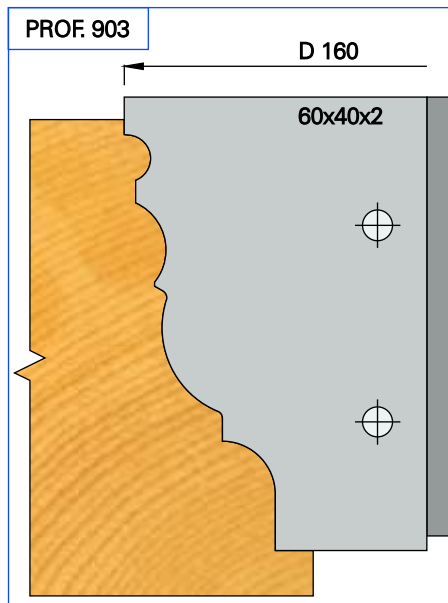
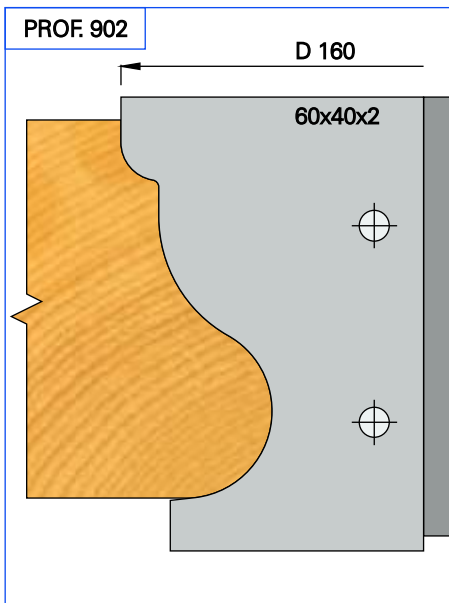
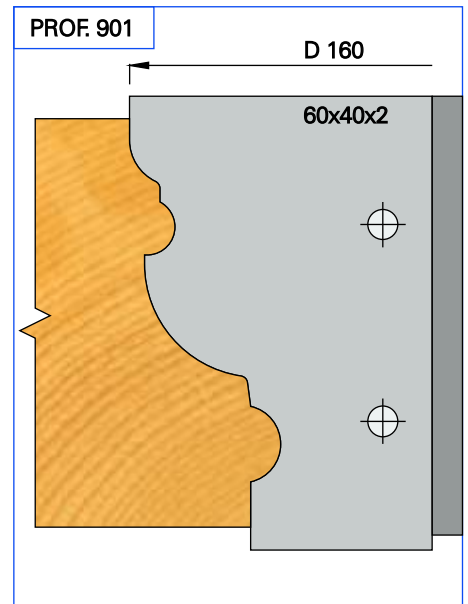
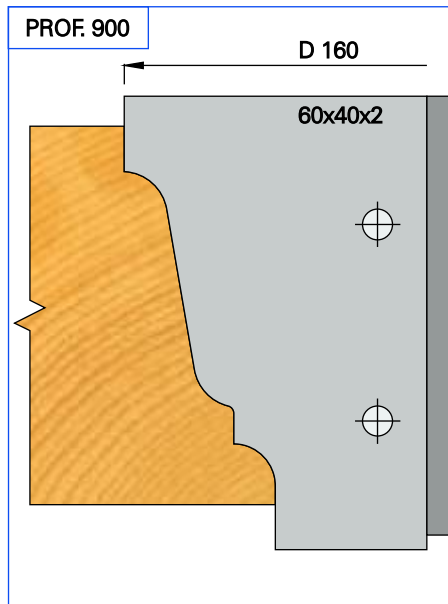
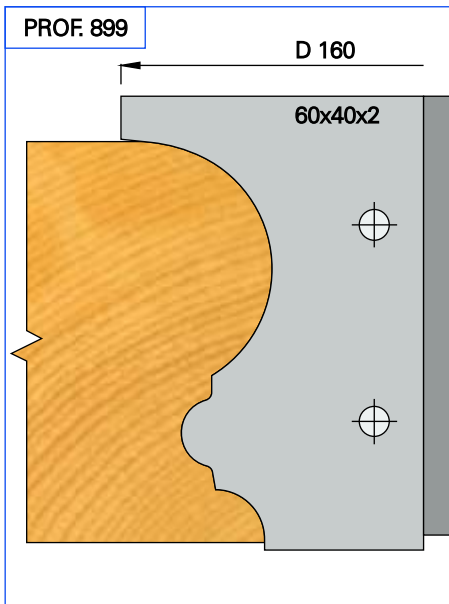

# 400 - L60

## Esempi di lavorazione



 Examples of workable profiles.

 Ejemplos de perfiles realizables.

 Exemples de profils réalisables.

 Durchführbaren Profilbeispiele.



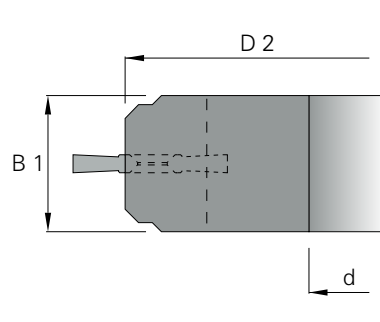

**HW**

**MEC**

n max 7000

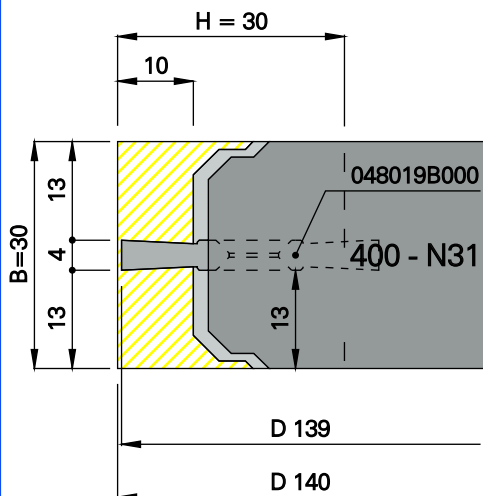
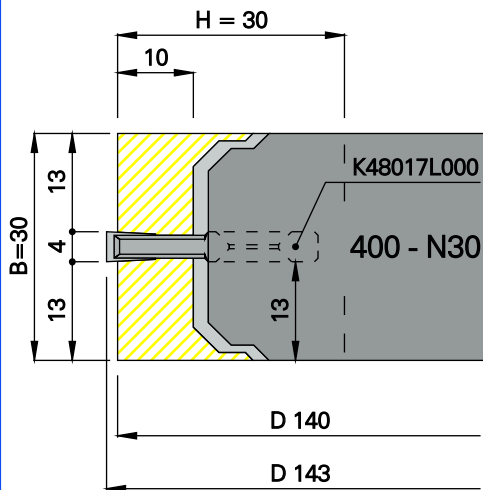

AREA PROFILABILE / PROFILING AREA

ART.	D 2	B 1	d	Z	COD.
400 - N30	116	30	30	3	0400N30030
	116	30	31.75	3	0400N30031
	116	30	35	3	0400N30035
	116	30	40	3	0400N30040
	116	30	50	3	0400N30050

ART.	B	H	a	COD.
401 - P	30	30	5	0401P30305

ART.	B	H	a	COD.
402 - P	30	30	2	0402P30302

ART.	B	H	a	COD.
403 - P	30	30	3	0403P30303

ART.	D 2	B 1	d	Z	COD.
400 - N31	116	30	30	3	0400N31030
	116	30	31.75	3	0400N31031
	116	30	35	3	0400N31035
	116	30	40	3	0400N31040
	116	30	50	3	0400N31050

ART.	B	H	a	COD.
401 - P	30	30	5	0401P30305

ART.	B	H	a	COD.
402 - P	30	30	2	0402P30302

ART.	B	H	a	COD.
403 - P	30	30	3	0403P30303



Multi - profiles cutter heads.



Cabezales multiperfiles.



Porte - outils multiprofiles.



Multiprofil - Messerköpfe.

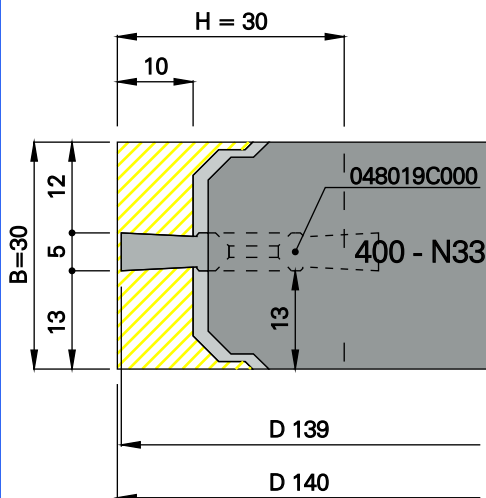
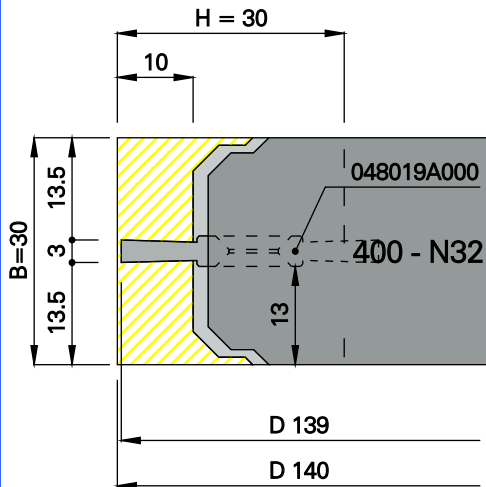

ART.	D 2	B 1	d	Z	COD.
400 - N32	116	30	30	3	0400N32030
	116	30	31.75	3	0400N32031
	116	30	35	3	0400N32035
	116	30	40	3	0400N32040
	116	30	50	3	0400N32050

ART.	B	H	a	COD.
401 - P	30	30	5	0401P30305

ART.	B	H	a	COD.
402 - P	30	30	2	0402P30302

ART.	B	H	a	COD.
403 - P	30	30	3	0403P30303

ART.	D 2	B 1	d	Z	COD.
400 - N33	116	30	30	3	0400N33030
	116	30	31.75	3	0400N33031
	116	30	35	3	0400N33035
	116	30	40	3	0400N33040
	116	30	50	3	0400N33050

ART.	B	H	a	COD.
401 - P	30	30	5	0401P30305

ART.	B	H	a	COD.
402 - P	30	30	2	0402P30302

ART.	B	H	a	COD.
403 - P	30	30	3	0403P30303

### Ricambi / Spare parts / Rechanges / Repuestos / Ersatzteile

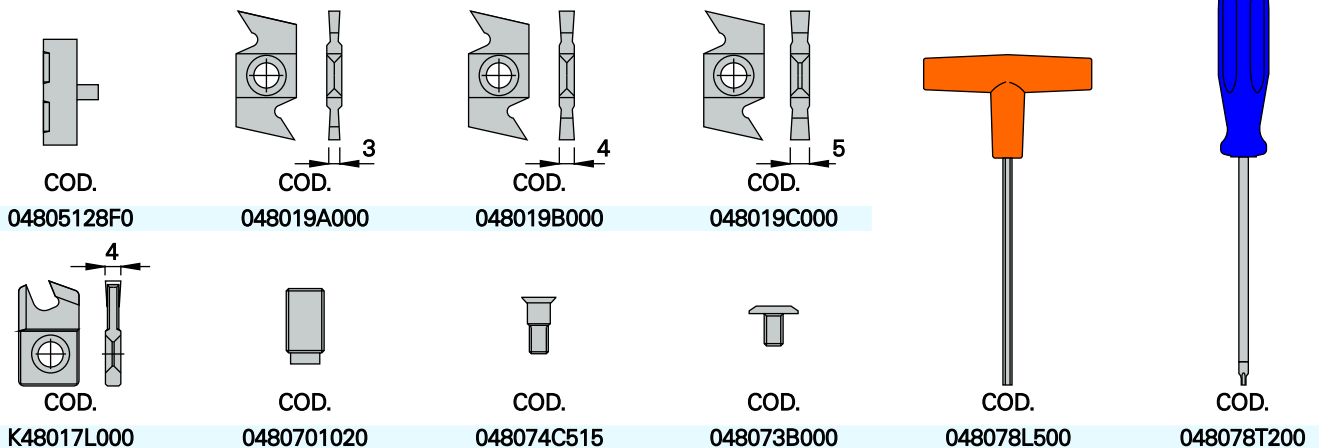

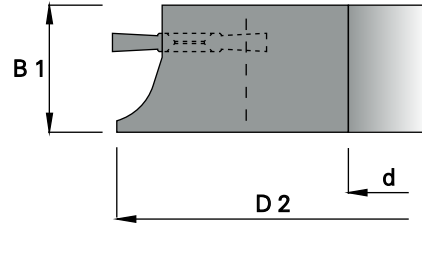

**HW**

**MEC**

n max 7000

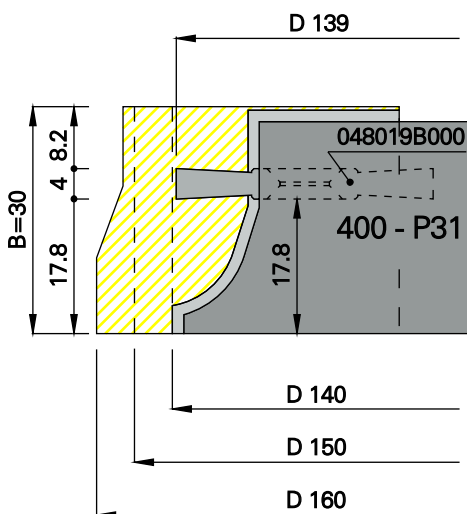
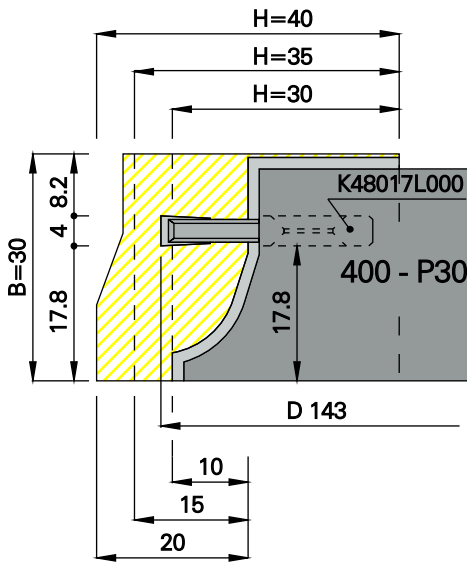

AREA PROFILABILE / PROFILING AREA

ART.	D 2	B 1	d	Z	COD.
400 - P30	137	28	30	3	0400P30030
	137	28	31.75	3	0400P30031
	137	28	35	3	0400P30035
	137	28	40	3	0400P30040
	137	28	50	3	0400P30050

ART.	B	H	a	COD.
401 - P	30	30	5	0401P30305
	30	35	5	0401P30355
	30	40	5	0401P30405

ART.	B	H	a	COD.
402 - P	30	30	2	0402P30302
	30	35	2	0402P30352
	30	40	2	0402P30402

ART.	B	H	a	COD.
403 - P	30	30	3	0403P30303
	30	35	3	0403P30353
	30	40	3	0403P30403

ART.	D 2	B 1	d	Z	COD.
400 - P31	137	28	30	3	0400P31030
	137	28	31.75	3	0400P31031
	137	28	35	3	0400P31035
	137	28	40	3	0400P31040
	137	28	50	3	0400P31050

ART.	B	H	a	COD.
401 - P	30	30	5	0401P30305
	30	35	5	0401P30355
	30	40	5	0401P30405

ART.	B	H	a	COD.
402 - P	30	30	2	0402P30302
	30	35	2	0402P30352
	30	40	2	0402P30402

ART.	B	H	a	COD.
403 - P	30	30	3	0403P30303
	30	35	3	0403P30353
	30	40	3	0403P30403



Multi - profiles cutter heads.



Cabezales multiperfiles.



Porte - outils multiprofiles.



Multiprofil - Messerköpfe.

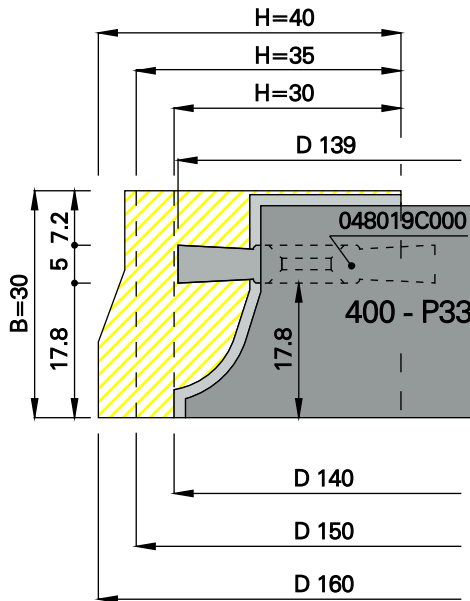
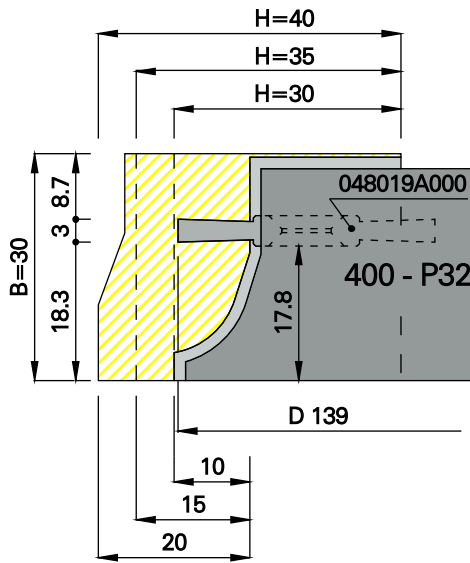

ART.	D 2	B 1	d	Z	COD.
400 - P32	137	28	30	3	0400P32030
	137	28	31.75	3	0400P32031
	137	28	35	3	0400P32035
	137	28	40	3	0400P32040
	137	28	50	3	0400P32050

ART.	B	H	a	COD.
401 - P	30	30	5	0401P30305
	30	35	5	0401P30355
	30	40	5	0401P30405

ART.	B	H	a	COD.
402 - P	30	30	2	0402P30302
	30	35	2	0402P30352
	30	40	2	0402P30402

ART.	B	H	a	COD.
403 - P	30	30	3	0403P30303
	30	35	3	0403P30353
	30	40	3	0403P30403

ART.	D 2	B 1	d	Z	COD.
400 - P33	137	28	30	3	0400P33030
	137	28	31.75	3	0400P33031
	137	28	35	3	0400P33035
	137	28	40	3	0400P33040
	137	28	50	3	0400P33050

ART.	B	H	a	COD.
401 - P	30	30	5	0401P30305
	30	35	5	0401P30355
	30	40	5	0401P30405

ART.	B	H	a	COD.
402 - P	30	30	2	0402P30302
	30	35	2	0402P30352
	30	40	2	0402P30402

ART.	B	H	a	COD.
403 - P	30	30	3	0403P30303
	30	35	3	0403P30353
	30	40	3	0403P30403

### Ricambi / Spare parts / Rechanges / Repuestos / Ersatzteile

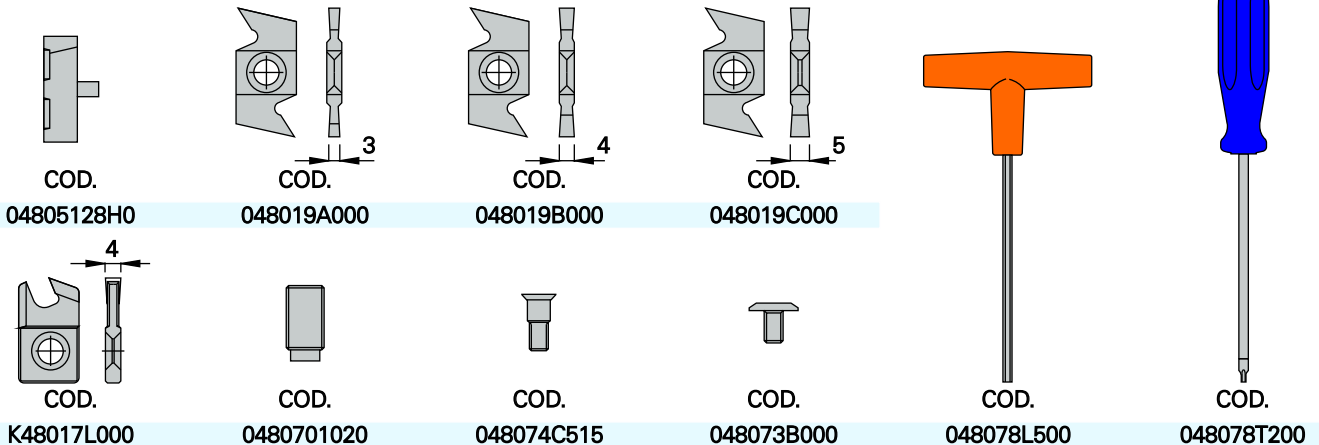

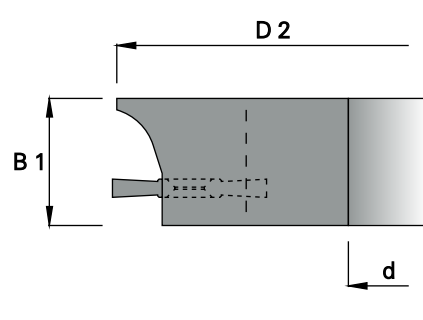

**HW**

**MEC**

n max 7000

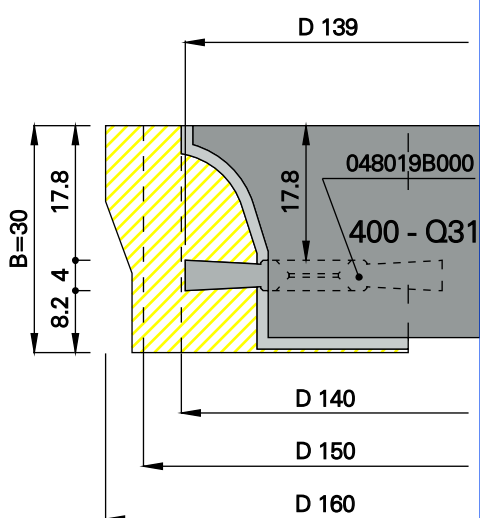
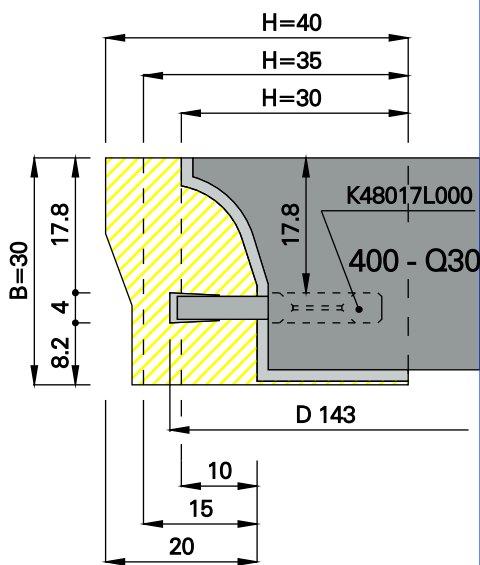

AREA PROFILABILE / PROFILING AREA

ART.	D 2	B 1	d	Z	COD.
400 - Q30	137	28	30	3	0400Q30030
	137	28	31.75	3	0400Q30031
	137	28	35	3	0400Q30035
	137	28	40	3	0400Q30040
	137	28	50	3	0400Q30050

ART.	B	H	a	COD.
401 - P	30	30	5	0401P30305
	30	35	5	0401P30355
	30	40	5	0401P30405

ART.	B	H	a	COD.
402 - P	30	30	2	0402P30302
	30	35	2	0402P30352
	30	40	2	0402P30402

ART.	B	H	a	COD.
403 - P	30	30	3	0403P30303
	30	35	3	0403P30353
	30	40	3	0403P30403

ART.	D 2	B 1	d	Z	COD.
400 - Q31	137	28	30	3	0400Q31030
	137	28	31.75	3	0400Q31031
	137	28	35	3	0400Q31035
	137	28	40	3	0400Q31040
	137	28	50	3	0400Q31050

ART.	B	H	a	COD.
401 - P	30	30	5	0401P30305
	30	35	5	0401P30355
	30	40	5	0401P30405

ART.	B	H	a	COD.
402 - P	30	30	2	0402P30302
	30	35	2	0402P30352
	30	40	2	0402P30402

ART.	B	H	a	COD.
403 - P	30	30	3	0403P30303
	30	35	3	0403P30353
	30	40	3	0403P30403



Multi - profiles cutter heads.



Cabezales multiperfiles.



Porte - outils multiprofiles.



Multiprofil - Messerköpfe.

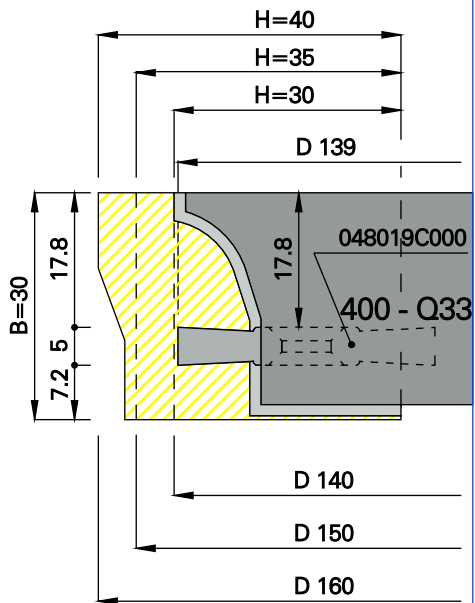
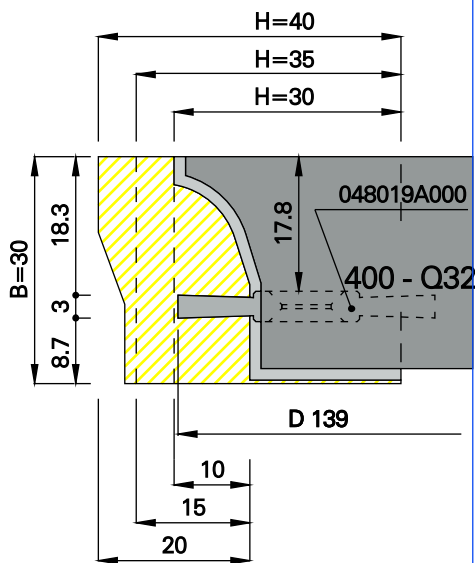

ART.	D 2	B 1	d	Z	COD.
400 - Q32	137	28	30	3	0400Q32030
	137	28	31.75	3	0400Q32031
	137	28	35	3	0400Q32035
	137	28	40	3	0400Q32040
	137	28	50	3	0400Q32050

ART.	B	H	a	COD.
401 - P	30	30	5	0401P30305
	30	35	5	0401P30355
	30	40	5	0401P30405

ART.	B	H	a	COD.
402 - P	30	30	2	0402P30302
	30	35	2	0402P30352
	30	40	2	0402P30402

ART.	B	H	a	COD.
403 - P	30	30	3	0403P30303
	30	35	3	0403P30353
	30	40	3	0403P30403

ART.	D 2	B 1	d	Z	COD.
400 - Q33	137	28	30	3	0400Q33030
	137	28	31.75	3	0400Q33031
	137	28	35	3	0400Q33035
	137	28	40	3	0400Q33040
	137	28	50	3	0400Q33050

ART.	B	H	a	COD.
401 - P	30	30	5	0401P30305
	30	35	5	0401P30355
	30	40	5	0401P30405

ART.	B	H	a	COD.
402 - P	30	30	2	0402P30302
	30	35	2	0402P30352
	30	40	2	0402P30402

ART.	B	H	a	COD.
403 - P	30	30	3	0403P30303
	30	35	3	0403P30353
	30	40	3	0403P30403

### Ricambi / Spare parts / Rechanges / Repuestos / Ersatzteile

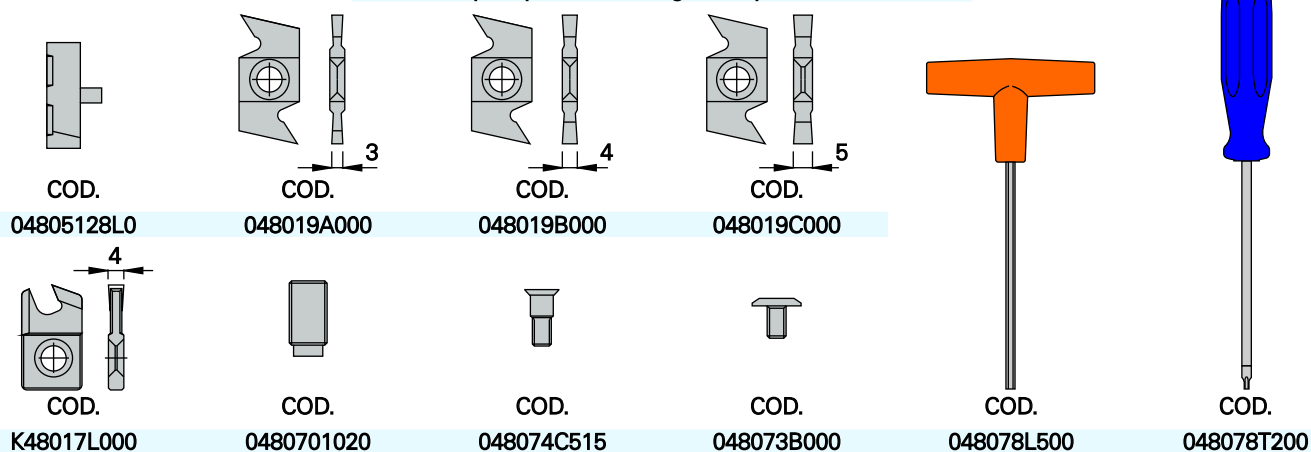

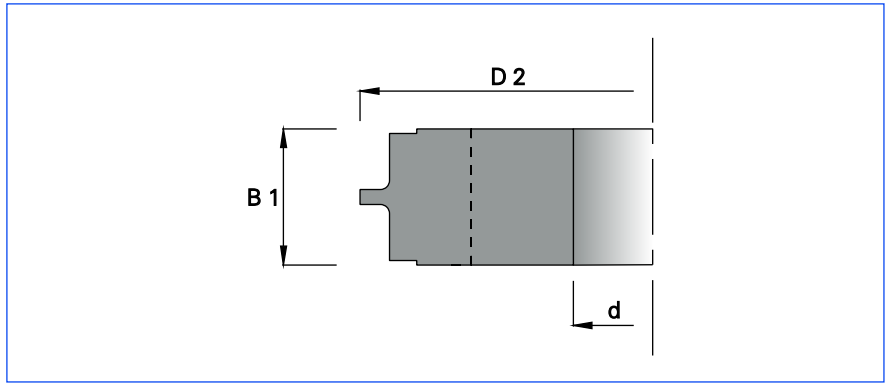

**HW**

**MEC**

n max 7000

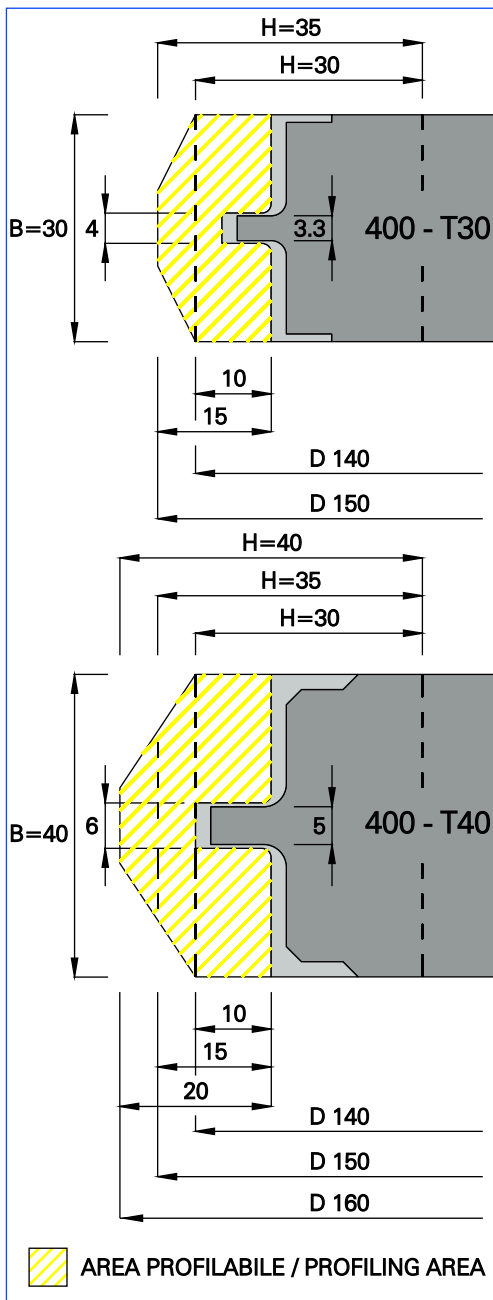

ART.	D 2	B 1	d	Z	COD.
400 - T30	129	30	30	3	0400T30030
	129	30	31.75	3	0400T30031
	129	30	35	3	0400T30035
	129	30	40	3	0400T30040
	129	30	50	3	0400T30050
ART.	B	H	a	COD.	
401 - P	30	30	5	0401P30305	
	30	35	5	0401P30355	
ART.	B	H	a	COD.	
402 - P	30	30	2	0402P30302	
	30	35	2	0402P30352	
ART.	B	H	a	COD.	
403 - P	30	30	3	0403P30303	
	30	35	3	0403P30353	
ART.	D 2	B 1	d	Z	COD.
400 - T40	136	40	30	3	0400T40030
	136	40	31.75	3	0400T40031
	136	40	35	3	0400T40035
	136	40	40	3	0400T40040
	136	40	50	3	0400T40050
ART.	B	H	a	COD.	
401 - P	40	30	5	0401P40305	
	40	35	5	0401P40355	
	40	40	5	0401P40405	
ART.	B	H	a	COD.	
402 - P	40	30	2	0402P40302	
	40	35	2	0402P40352	
	40	40	2	0402P40402	
ART.	B	H	a	COD.	
403 - P	40	30	3	0403P40303	
	40	35	3	0403P40353	
	40	40	3	0403P40403	

Multi - profiles cutter heads.

Cabezales multiperfiles.

Porte - outils multiprofiles.

Multiprofil - Messerköpfe.



Ricambi / Spare parts / Rechanges / Repuestos / Ersatzteile

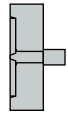

COD.  
04805128T0

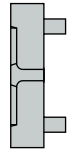

COD.  
04805138T0



COD.  
0480701020



COD.  
048073B000

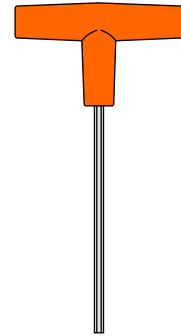

COD.  
048078L500

## 400

## Esempi di lavorazione

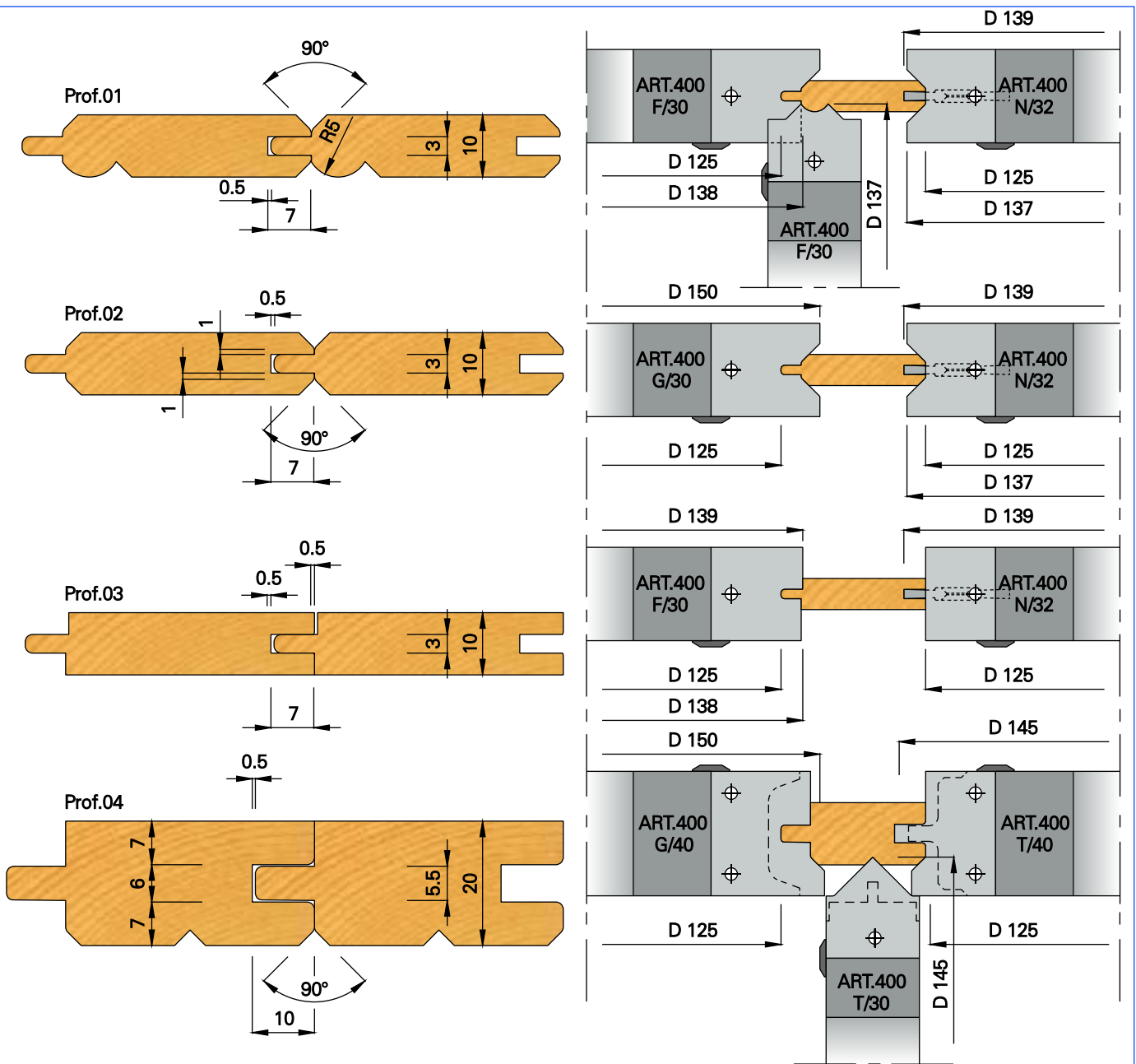

 Examples of workable profiles.

 Ejemplos de perfiles realizables.

 Exemples de profils réalisables.

 Durchführbaren Profilbeispiele.



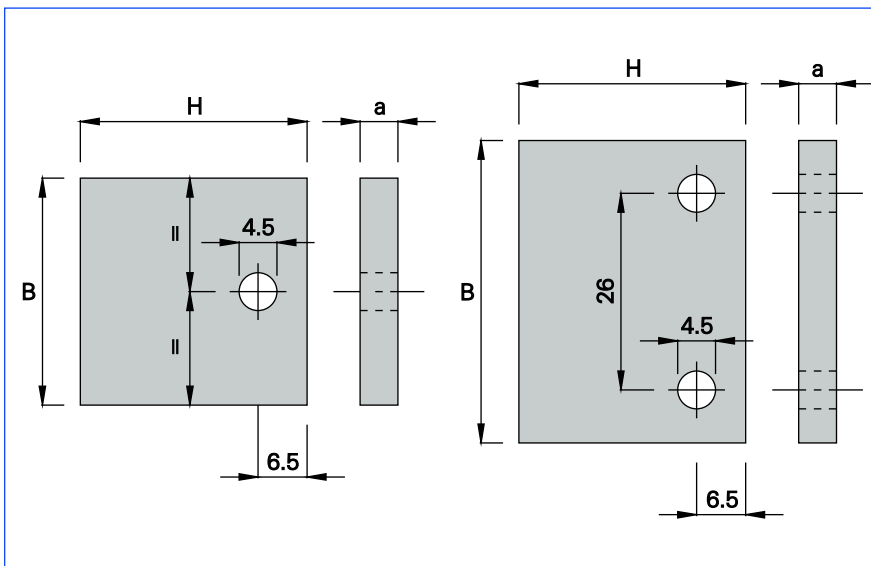
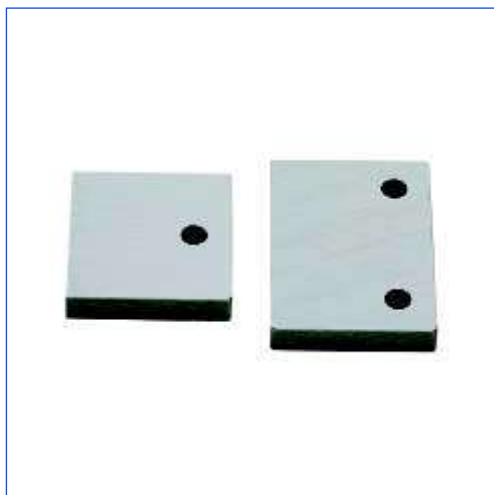

**SP**

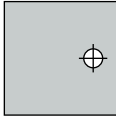
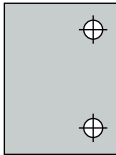

	B	H	a	COD.
	30	30	5	0401G30305
	30	35	5	0401G30355
	30	40	5	0401G30405
	B	H	a	COD.
	40	30	5	0401G40305
	40	35	5	0401G40355
	40	40	5	0401G40405
	60	30	5	0401G60305
	60	35	5	0401G60355
	60	40	5	0401G60405
	80	30	5	0401G80305
	80	35	5	0401G80355
	80	40	5	0401G80405

 Blank support plates.

 Placas de apoyo para perfilar.

 Plaquettes de support à profiler.

 Unprofilierte Stützplatten.

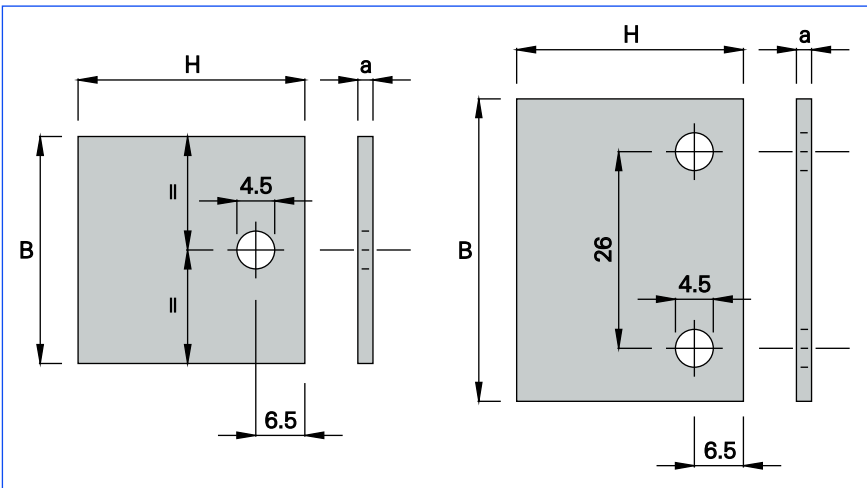
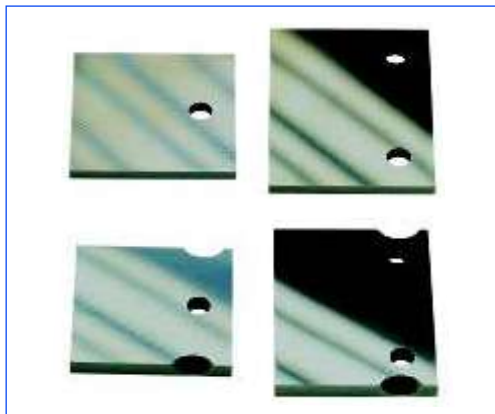

HW

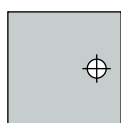

B	H	a	COD.
30	30	2	0402G30302
30	35	2	0402G30352
30	40	2	0402G30402

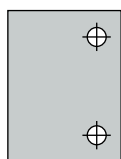

40	30	2	0402G40302
40	35	2	0402G40352
40	40	2	0402G40402
60	30	2	0402G60302
60	35	2	0402G60352
60	40	2	0402G60402
80	30	2	0402G80302
80	35	2	0402G80352
80	40	2	0402G80402

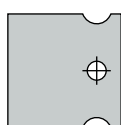

B	H	a	COD.
30	30	3	0403G30303
30	35	3	0403G30353
30	40	3	0403G30403

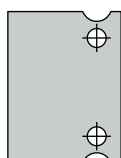

40	30	3	0403G40303
40	35	3	0403G40353
40	40	3	0403G40403
60	30	3	0403G60303
60	35	3	0403G60353
60	40	3	0403G60403
80	30	3	0403G80303
80	35	3	0403G80353
80	40	3	0403G80403

Blank carbide plates.

Placas de metal duro para perfilar.

Plaquettes en carbure à profiler.

Unprofilierte Hartmetall - Platten.



**HW**

**MEC**

n max 7000

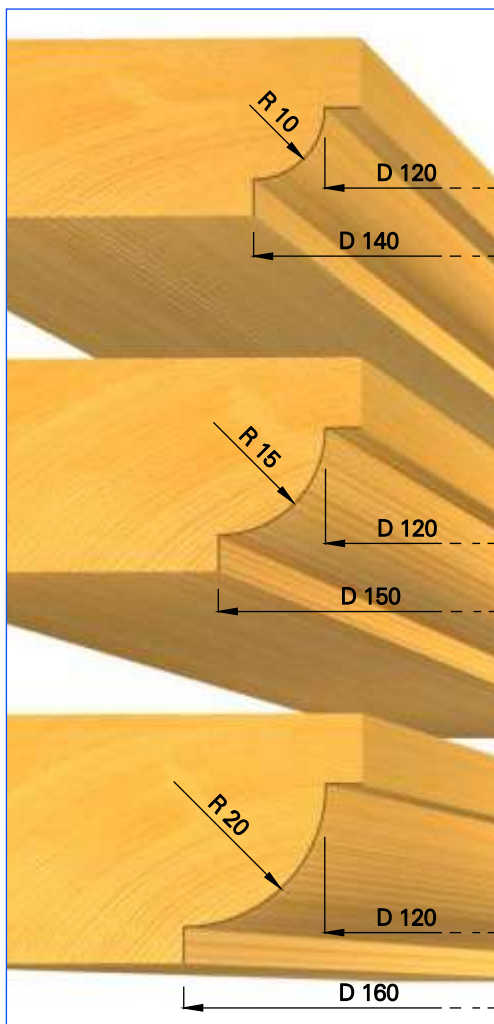
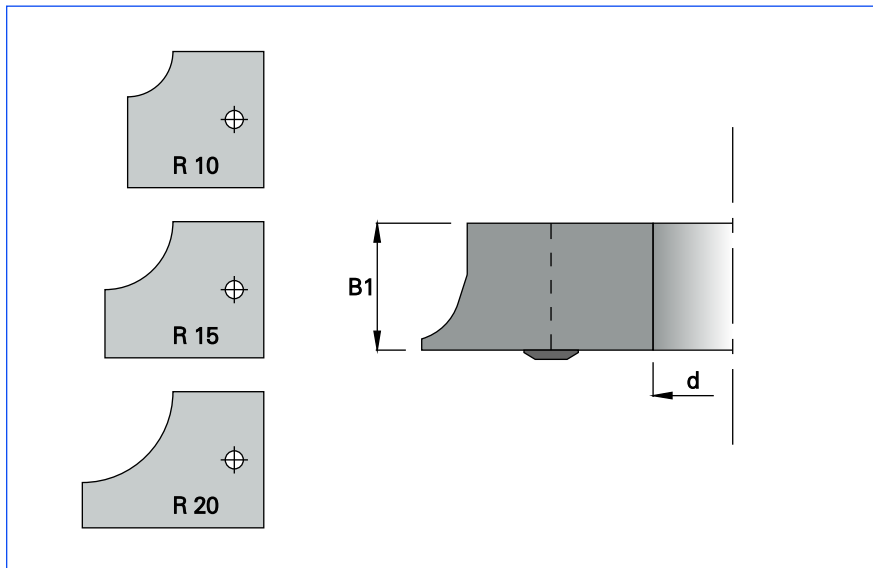

B1	d	Z	COD. SET
28	30	3	0405A10030
28	31.75	3	0405A10031
28	35	3	0405A10035
28	40	3	0405A10040
28	50	3	0405A10050

Il set è composto da:

- 1 Testa Art 400 H 30 ;
- 3 Terne di piastrelle Art 401 P / R = 10 - 15 - 20 ;
- 3 Terne di placchette Art 402 P / R = 10 - 15 - 20 ;
- 1 Chiave di serraggio ;
- 1 Cassetta in legno .

### Ricambi / Spare parts / Rechanges / Repuestos / Ersatzteile

Inserto	Inserto	Inserto			
COD.	COD.	COD.	COD.	COD.	COD.
0402P82800	0402P82900	0402P83000	04805128H0		
Supporto	Supporto	Supporto			
COD.	COD.	COD.	COD.	COD.	COD.
0401P82800	0401P82900	0401P83000	048073B000	0480701020	048078L500



Set multi - profile.

The set includes :

- 1 Cutter head Art 400 H 30 ;
- 3 Terns of plates Art 401 P R = 10 - 15 - 20 ;
- 3 Terns of plates Art 402 P R = 10 - 15 - 20 ;
- 1 Allen key ;
- 1 Wooden case.



Coffret multiprofiles.

Le jeu comprend :

- 1 Porte - outils Art 400 H 30 ;
- 3 Jeux de 3 plaquettes Art 401 P R = 10 - 15 - 20 ;
- 3 Jeux de 3 plaquettes Art 402 P R = 10 - 15 - 20 ;
- 1 Clef ;
- 1 Boite en bois.



Estuche multiperfiles.

El juego comprende :

- 1 Cabezal Art 400 H 30 ;
- 3 Ternos de plaquetas Art 401 P R = 10 - 15 - 20 ;
- 3 Ternos de cuchillas Art 402 P R = 10 - 15 - 20 ;
- 1 Llave ;
- 1 Estuche de madera.



Multi - Profiler Satz.

Der Satz besteht aus :

- 1 Messerkopf Art 400 H 30 ;
- 3 Platten - Dreieiten Art 401 P R = 10 - 15 - 20 ;
- 3 Platten - Dreieiten Art 402 P R = 10 - 15 - 20 ;
- 1 Schraubendreher ;
- 1 Holz - Etui.



**HW**

**MEC**

n max 7000

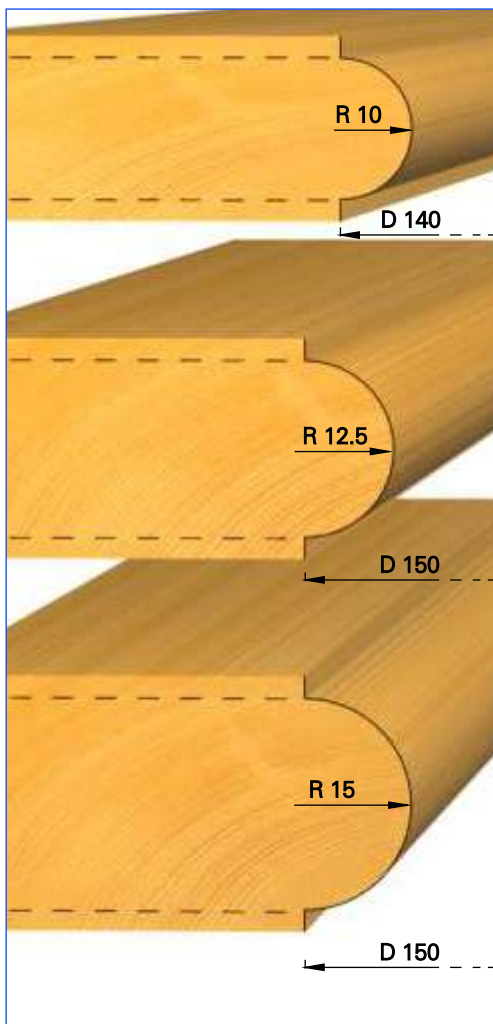
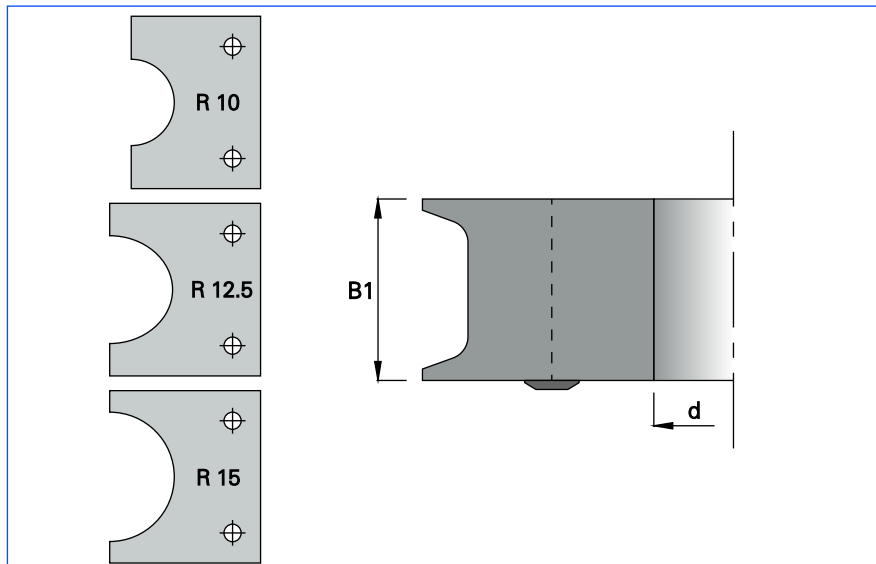

B1	d	Z	COD. SET
40	30	3	0405B10030
40	31.75	3	0405B10031
40	35	3	0405B10035
40	40	3	0405B10040
40	50	3	0405B10050

Il set è composto da:  
 - 1 Testa Art 400 G 40 ;  
 - 3 Terne di piastrelle Art 401 P / R = 10 - 12.5 - 15 ;  
 - 3 Terne di placchette Art 402 P / R = 10 - 12.5 - 15 ;  
 - 1 Chiave di serraggio ;  
 - 1 Cassetta in legno .

**Ricambi / Spare parts / Rechanges / Repuestos / Ersatzteile**

Inserto	Inserto	Inserto			
COD.	COD.	COD.	COD.		
0402P85600	0402P85700	0402P85800	04805138G0		
Supporto	Supporto	Supporto			
COD.	COD.	COD.	COD.	COD.	COD.
0401P85600	0401P85700	0401P85800	048073B000	0480701020	048078L500

**Set multi - profile.**  
 The set includes :  
 - 1 Cutter head Art 400 G 40 ;  
 - 3 Terns of plates Art 401 P R = 10 - 12.5 - 15 ;  
 - 3 Terns of plates Art 402 P R = 10 - 12.5 - 15 ;  
 - 1 Allen key ;  
 - 1 Wooden case.

**Coffret multiprofiles.**  
 Le jeu comprend :  
 - 1 Porte - outils Art 400 G 40 ;  
 - 3 Jeux de 3 plaquettes Art 401 P R = 10 - 12.5 - 15 ;  
 - 3 Jeux de 3 plaquettes Art 402 P R = 10 - 12.5 - 15 ;  
 - 1 Clef ;  
 - 1 Boite en bois.

**Estuche multiperfiles.**  
 El juego comprende :  
 - 1 Cabezal Art 400 G 40 ;  
 - 3 Ternos de plaquetas Art 401 P R = 10 - 12.5 - 15 ;  
 - 3 Ternos de cuchillas Art 402 P R = 10 - 12.5 - 15 ;  
 - 1 Llave ;  
 - 1 Estuche de madera.

**Multi - Profiler Satz.**  
 Der Satz besteht aus :  
 - 1 Messerkopf Art 400 G 40 ;  
 - 3 Platten - Dreitheiten Art 401 P R = 10 - 12.5 - 15 ;  
 - 3 Platten - Dreitheiten Art 402 P R = 10 - 12.5 - 15 ;  
 - 1 Schraubendreher ;  
 - 1 Holz - Etui.



**HW**

**MAN**

D = 160 - n 4800 - 8300  
D = 170 - n 4500 - 7800

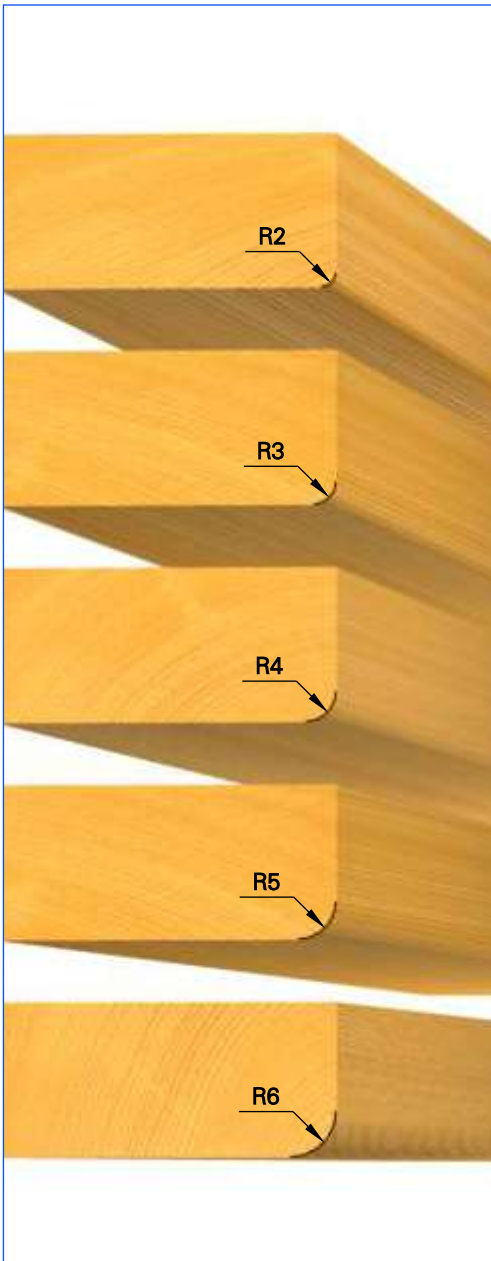
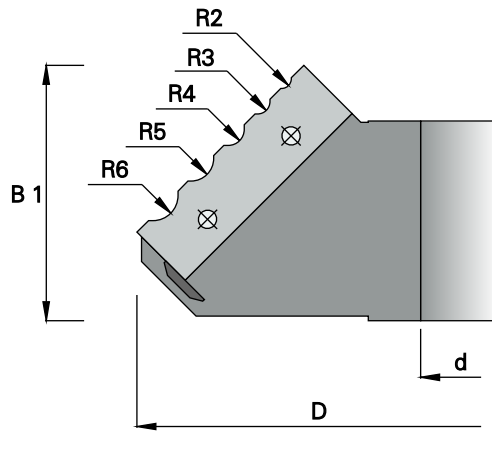

D	B1	d	Z	COD.
160	57	30	2	K405C00030
160	57	31.75	2	K405C00031
160	57	35	2	K405C00035
160	57	40	2	K405C00040
170	57	50	2	K405C00050

### Ricambi / Spare parts / Rechanges / Repuestos / Ersatzteile

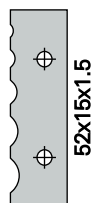

COD.  
048035C000



COD.  
048050AUVZ



COD.  
048060C000



COD.  
0480700612



COD.  
048073B000

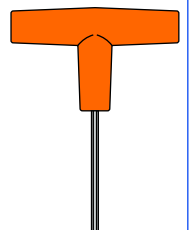

COD.  
0480783000

 Multi - profiles cutter head.

 Cabezal multiperfiles.

 Porte - outil multiprofiles.

 Multiprofil - Messerkopf.



**HW**

**MAN**

D = 160 - n 4800 - 8300  
D = 170 - n 4500 - 7800

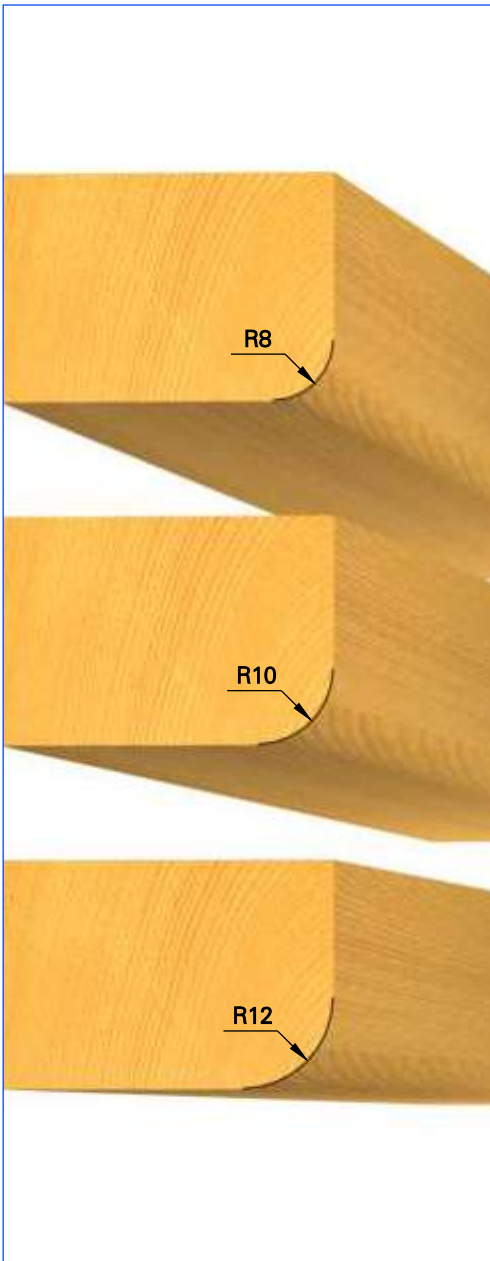
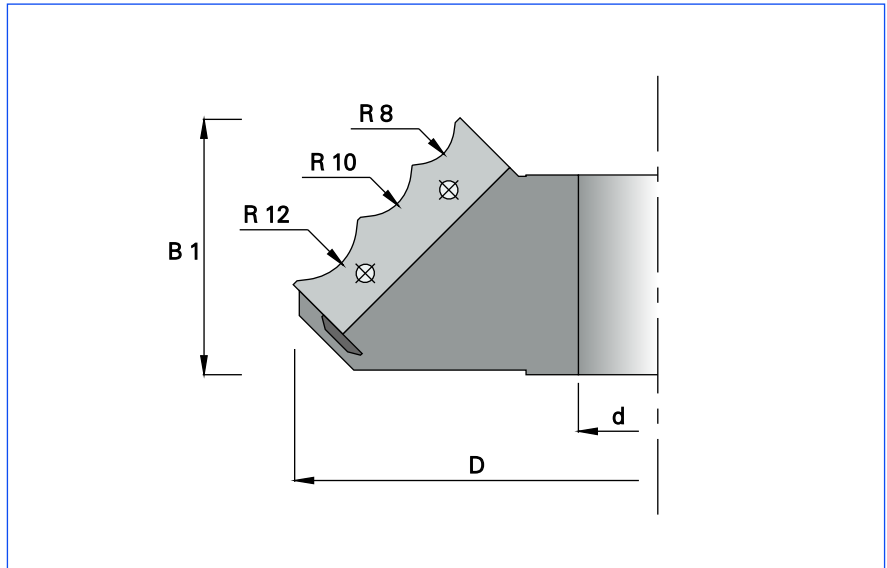

D	B1	d	Z	COD.
160	57	30	2	K405D00030
160	57	31.75	2	K405D00031
160	57	35	2	K405D00035
160	57	40	2	K405D00040
170	57	50	2	K405D00050

### Ricambi / Spare parts / Rechanges / Repuestos / Ersatzteile

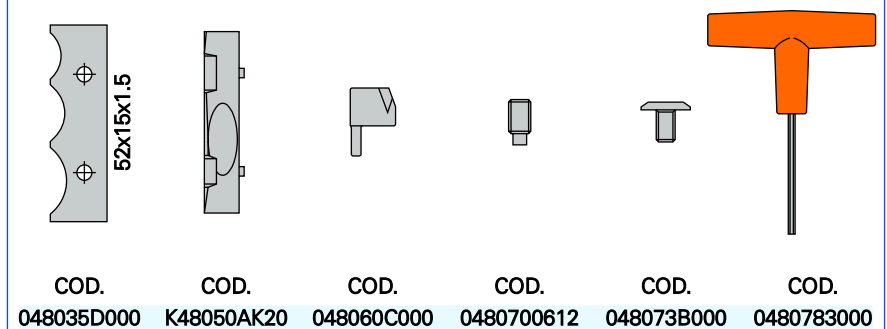

Multi - profiles cutter head.

Cabezal multiperfiles.

Porte - outil multiprofiles.

Multiprofil - Messerkopf.



**HW**

**MAN**

D 140 n 5500 - 9500  
D 160 n 4800 - 8300

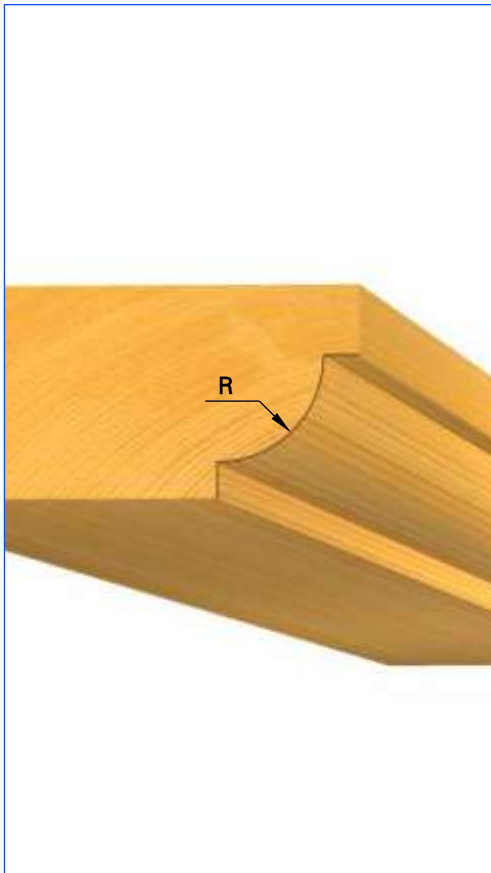
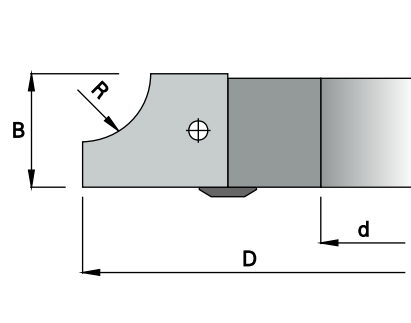

D	R	B	d	Z	COD.
140	7.5	15	30	2	K405H00730
140	7.5	15	31.75	2	K405H00731
140	7.5	15	35	2	K405H00735
140	7.5	15	40	2	K405H00740
140	7.5	15	50	2	K405H00750
140	10	20	30	2	K405H01030
140	10	20	31.75	2	K405H01031
140	10	20	35	2	K405H01035
140	10	20	40	2	K405H01040
140	10	20	50	2	K405H01050
140	12.5	20	30	2	K405H01230
140	12.5	20	31.75	2	K405H01231
140	12.5	20	35	2	K405H01235
140	12.5	20	40	2	K405H01240
140	12.5	20	50	2	K405H01250
140	15	25	30	2	K405H01530
140	15	25	31.75	2	K405H01531
140	15	25	35	2	K405H01535
140	15	25	40	2	K405H01540
140	15	25	50	2	K405H01550
160	20	30	30	2	K405H02030
160	20	30	31.75	2	K405H02031
160	20	30	35	2	K405H02035
160	20	30	40	2	K405H02040
160	20	30	50	2	K405H02050

### Ricambi / Spare parts / Rechanges / Repuestos / Ersatzteile



COD.

0402P92200

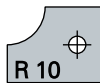

COD.

0402P92300

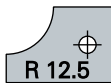

COD.

0402P92400

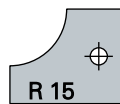

COD.

0402P92500

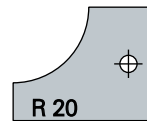

COD.

0402P92600



COD.

0480521325



COD.

0480521825



COD.

048053232L



COD.

048053282L



COD.

0480700820



COD.

048073B000

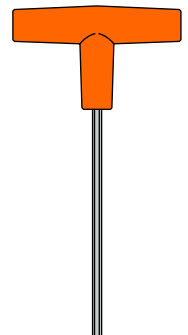

COD.

048078L400



Cutter head for quarter round.



Cabezal para cuartos de redondo.



Porte outil pour quart de rond.



Viertelstab-Messerkopf.



**HW**

**MAN**

D 190 n 4100 - 6000  
D 210 n 3700 - 5400  
D 230 n 3400 - 4900

– corpo in lega leggera

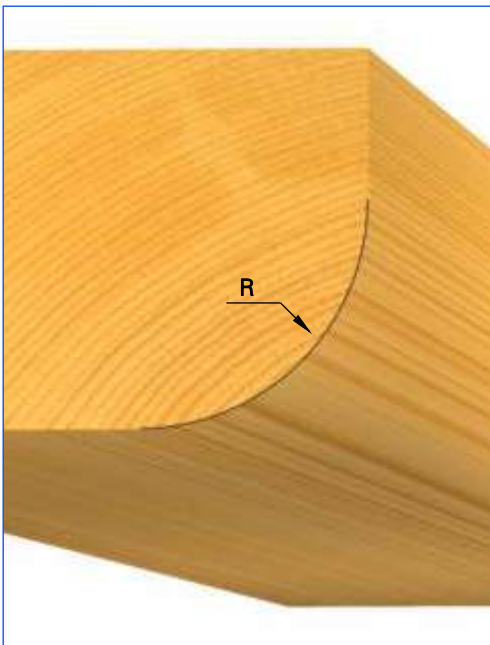
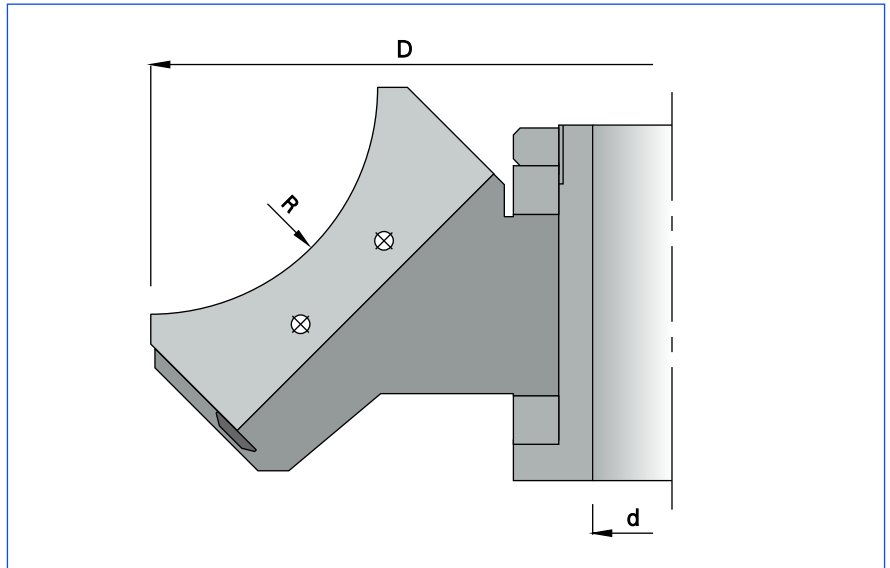

D	R	d	Z	COD.
190	30	30	3	K405L03030
190	30	31.75	3	K405L03031
190	30	35	3	K405L03035
190	30	40	3	K405L03040
190	30	50*	3	K405L03050
210	40	30	3	K405L04030
210	40	31.75	3	K405L04031
210	40	35	3	K405L04035
210	40	40	3	K405L04040
210	40	50*	3	K405L04050
230	50	30	3	K405L05030
230	50	31.75	3	K405L05031
230	50	35	3	K405L05035
230	50	40	3	K405L05040
230	50	50*	3	K405L05050

\* Senza mozzo / Without sleeve / Sans manchon / Sin casquillo / Ohne Spannbuchse.

### Ricambi / Spare parts / Rechanges / Repuestos / Ersatzteile

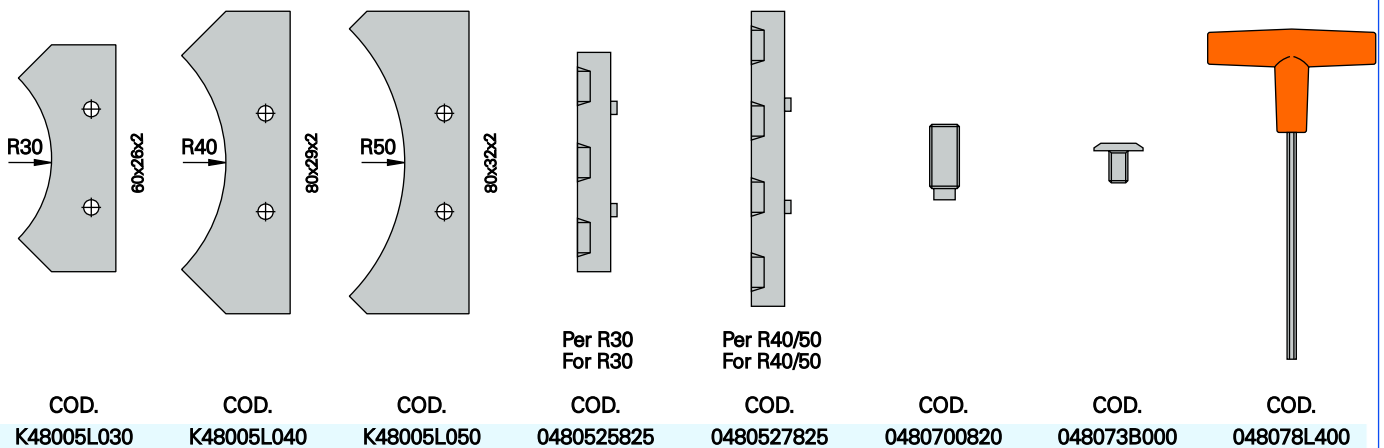

COD. K48005L030	COD. K48005L040	COD. K48005L050	COD. 0480525825	COD. 0480527825	COD. 0480700820	COD. 048073B000	COD. 048078L400
--------------------	--------------------	--------------------	--------------------	--------------------	--------------------	--------------------	--------------------

Cutter head for quarter round.  
Light alloy tool body.

Cabezal para cuartos de redondo.  
Cuerpo de aleacion legera.

Porte outil pour quart de rond.  
Corps en alliage léger.

Viertelstab-Messerkopf.  
Tragkörper aus Leichtmetall.





**HW**

**MAN**

n 4800 - 8300

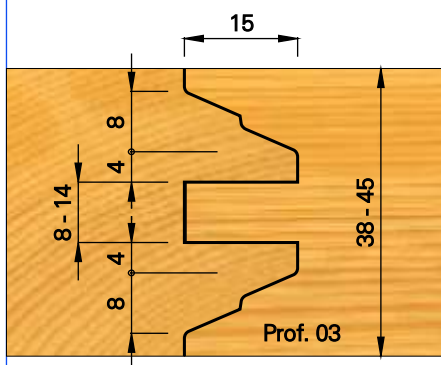
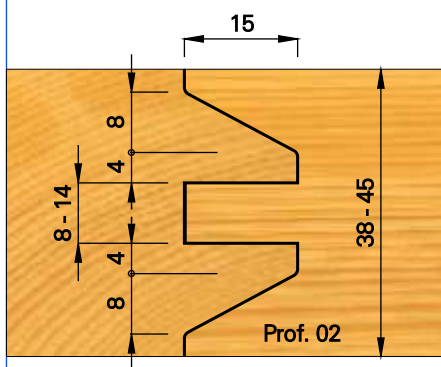
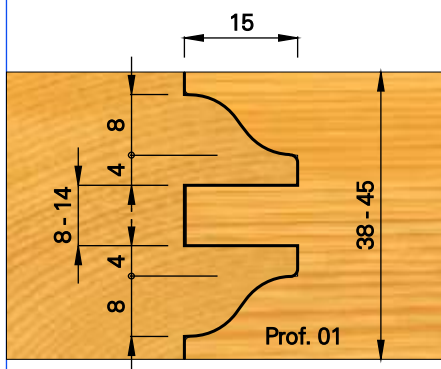
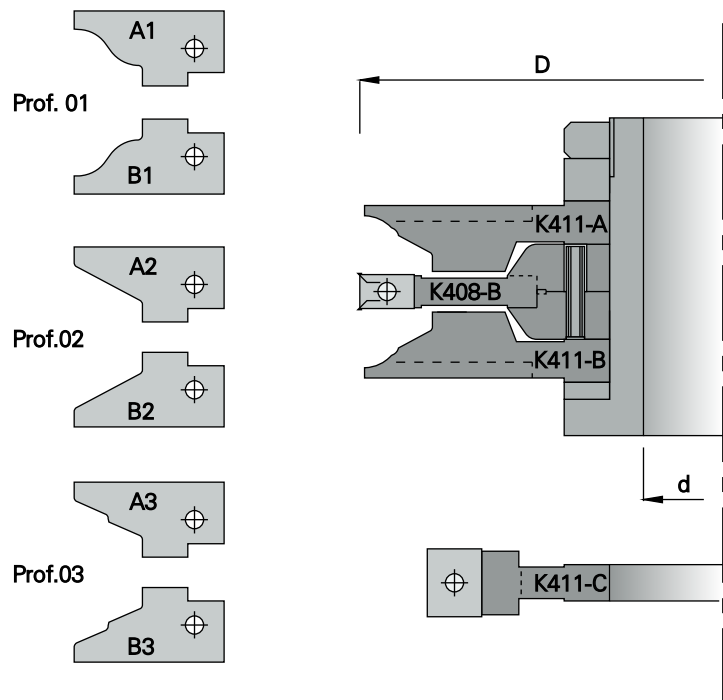

### SET COMPLETO DI INSERTI PER PROFILI 01 - 02 - 03.

D	d	Z	COD. SET
160	30	2	K411013000
160	31.75	2	K411013100
160	35	2	K411013500
160	40	2	K411014000
160	50*	2	K411015000

\* Senza mozzo / Without sleeve / Sans manchon / Sin casquillo / Ohne Spannbochse.

ART.	D	COD.
K408 - B	160	K408160850
K411 - A**	160	K411A05000
K411 - B**	160	K411B05000
K411 - C	130.4	K411C05000

\*\* Senza inserti / Without inserts / Sans plaquettes / Sin cuchillas / Ohne Messer.



## ESEMPIO DI LAVORAZIONE.

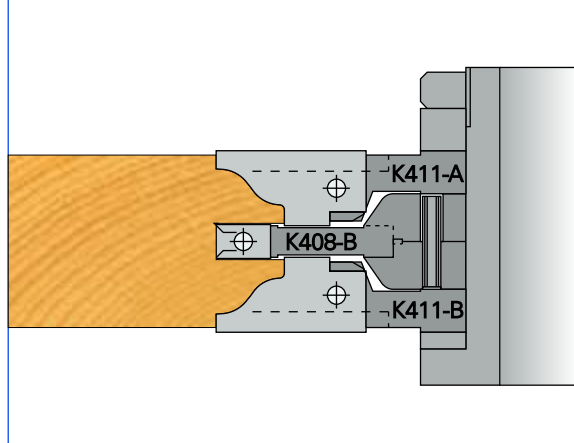
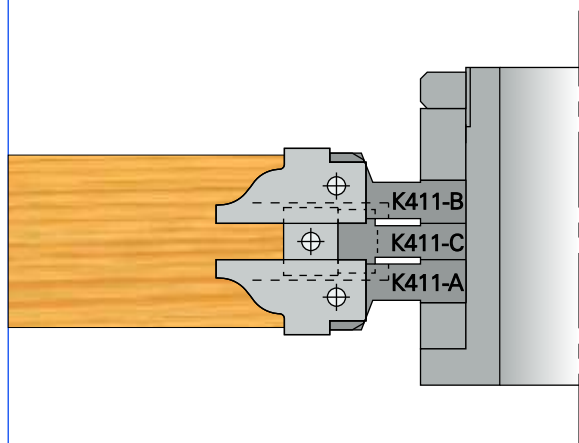

## Ricambi / Spare parts / Rechanges / Repuestos / Ersatzteile

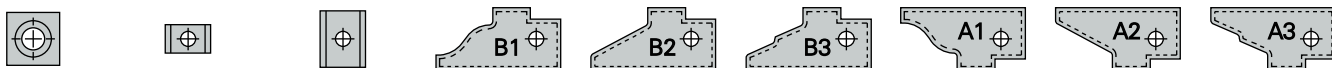

COD.	COD.	COD.	COD.	COD.	COD.	COD.	COD.	COD.	COD.
0480030014	0480050007	0480050015	K48011B100	K48011B200	K48011B300	K48011A100	K48011A200	K48011A300	

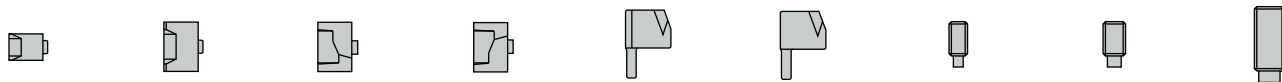

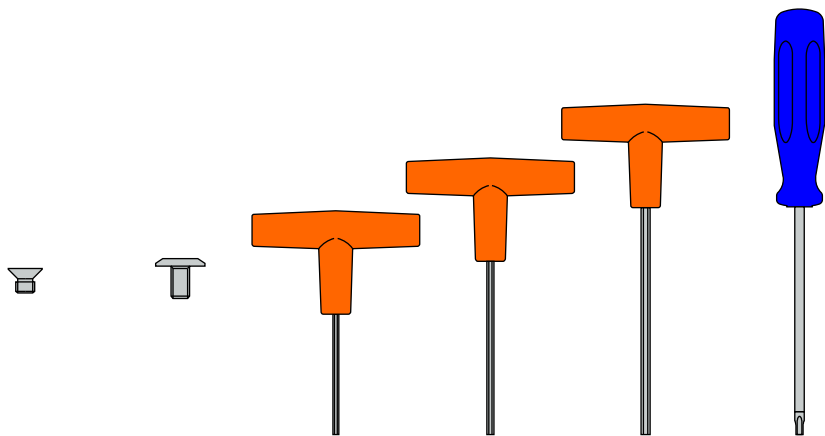

COD.	COD.	COD.	COD.	COD.	COD.	COD.	COD.	COD.	COD.
0480500700	0480501300	048053132R	048053132L	048060A000	048060C000	0480700512	0480700612	0480700820	



COD.	COD.	COD.	COD.	COD.	COD.
048074A507	048073B000	0480782500	0480783000	048078L400	048078T200

 Multiprofile cutter head set for internal doors.

 Juego de cabezales multiperfiles para puertas.

 Jeu de porte - outils multiprofiles pour portes.

 Multi - Profiler Messerkopfsatz für Innentüren.



**HW**

**MAN**

n 4800 - 8300

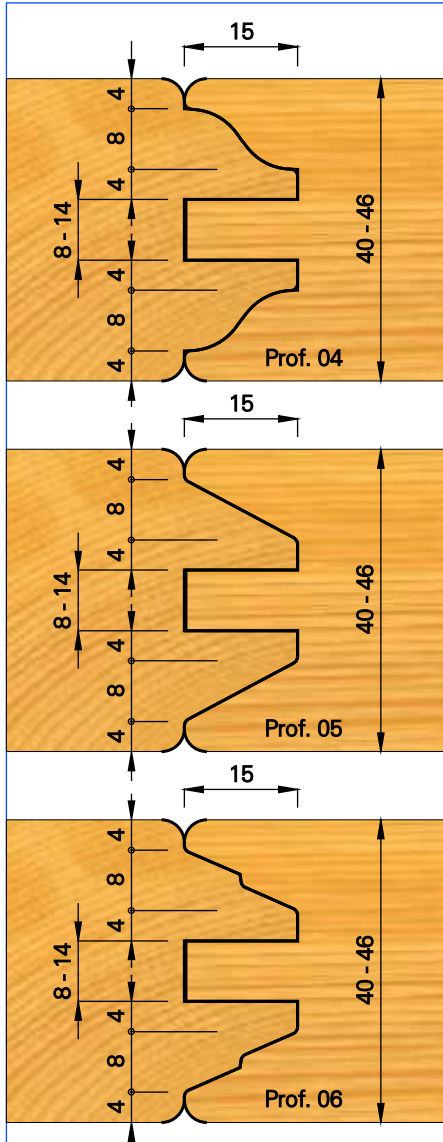
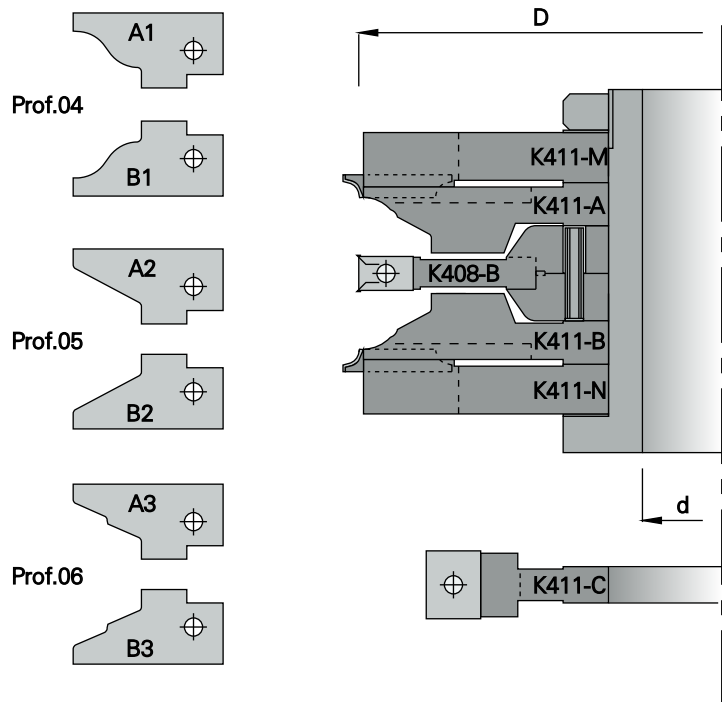

### SET COMPLETO DI INSERTI PER PROFILI 04 - 05 - 06.

D	d	Z			
			COD.	COD.	COD.
160	30	2	K411023045	K4110230R1	K4110230R3
160	31.75	2	K411023145	K4110231R1	K4110231R3
160	35	2	K411023545	K4110235R1	K4110235R3
160	40	2	K411024045	K4110240R1	K4110240R3
160	50*	2	K411025045	K4110250R1	K4110250R3

\* Senza mozzo / Without sleeve / Sans manchon / Sin casquillo / Ohne Spannbuchse.

ART.	D			
		COD.	COD.	COD.
K408 - B	160	K408160850	K408160850	K408160850
K411 - A**	160	K411A05045	K411A050R1	K411A050R3
K411 - B**	160	K411B05045	K411B050R1	K411B050R3
K411 - C	130.4	K411C05000	K411C05000	K411C05000
K411 - M	160	K411M05045	K411M050R1	K411M050R3
K411 - N	160	K411N05045	K411N050R1	K411N050R3

\*\* Senza inserti / Without inserts / Sans plaquettes / Sin cuchillas / Ohne Messer.



### ESEMPIO DI LAVORAZIONE.

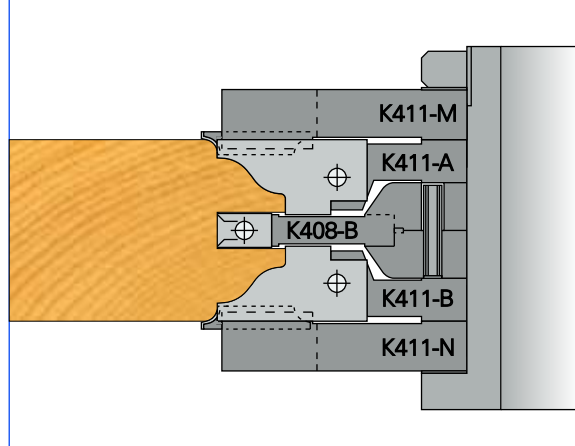
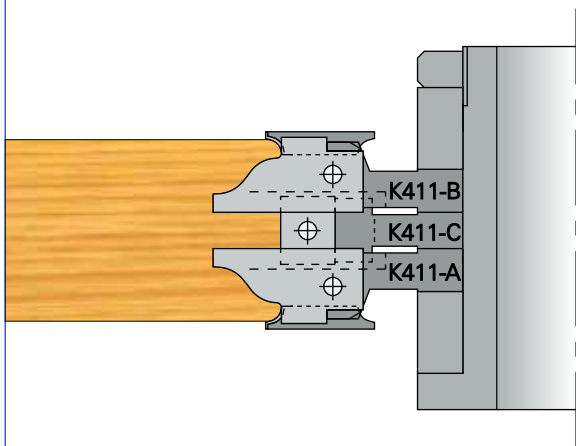

### Ricambi / Spare parts / Rechanges / Repuestos / Ersatzteile

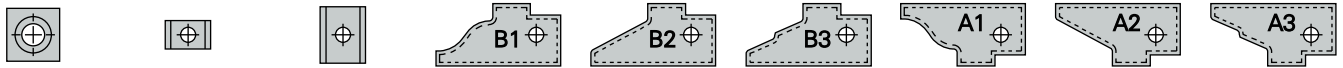

COD.	COD.	COD.	COD.	COD.	COD.	COD.	COD.	COD.
0480030014	0480050007	0480050015	K48011B100	K48011B200	K48011B300	K48011A100	K48011A200	K48011A300

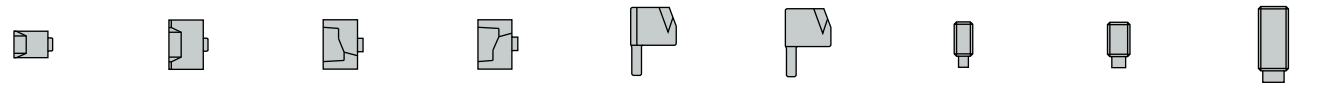

COD.	COD.	COD.	COD.	COD.	COD.	COD.	COD.	COD.
0480500700	0480501300	048053132R	048053132L	048060A000	048060C000	0480700512	0480700612	0480700820

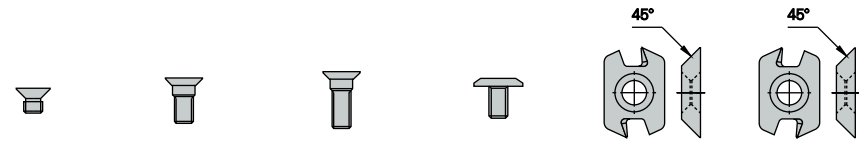

COD.	COD.	COD.	COD.	COD.	COD.
048074A507	048074B512	048074B515	048073B000	K480110000	K480120000

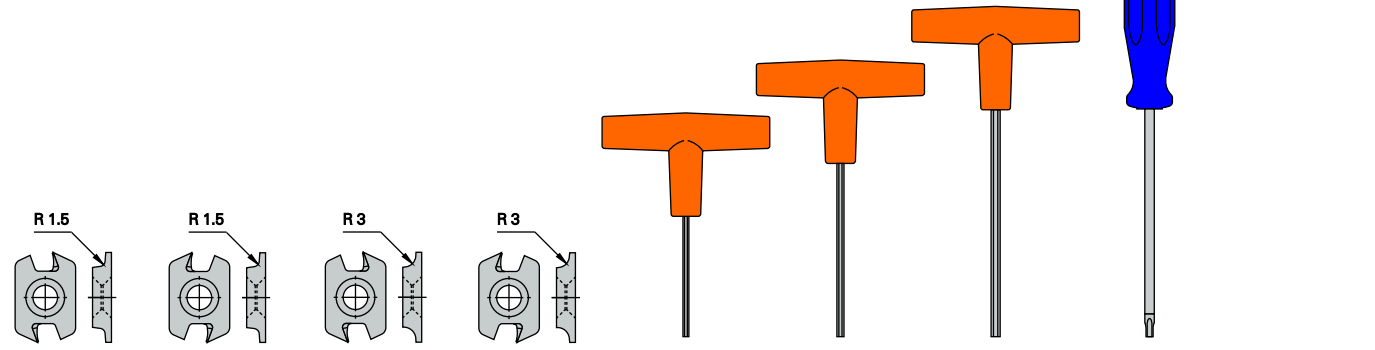

COD.	COD.	COD.	COD.	COD.	COD.	COD.	COD.
K480130000	K480140000	K480150000	K480160000	0480782500	0480783000	048078L400	048078T200

 Multiprofile cutter head set for internal doors.	 Juego de cabezales multiperfiles para puertas.
 Jeu de porte - outils multiprofiles pour portes.	 Multi - Profiler Messerkopfsatz für Innentüren.



**HW**

**MAN**

n 4800 - 8300

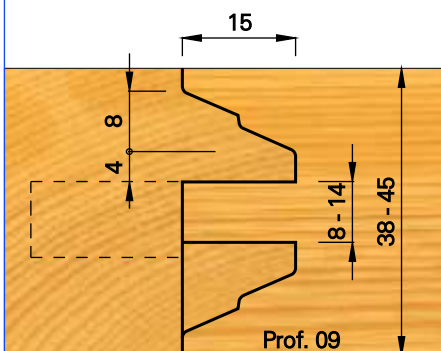
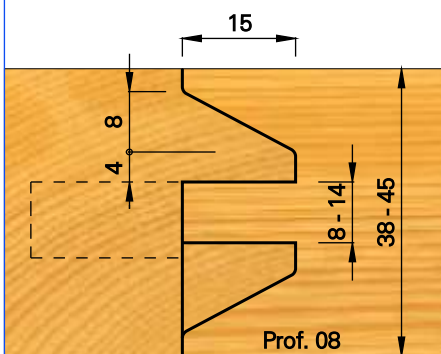
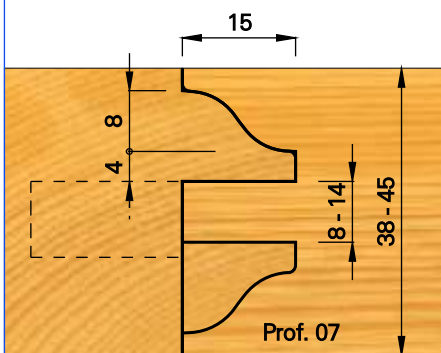
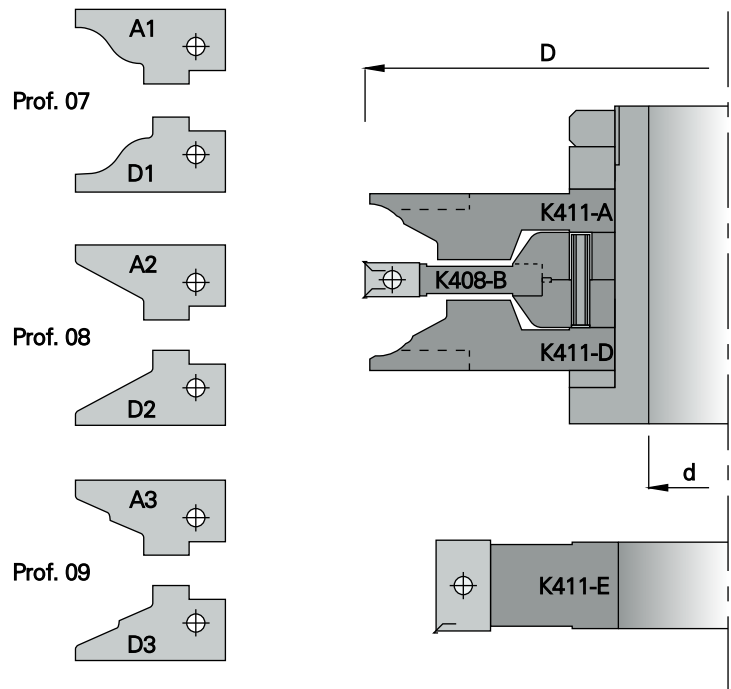

### SET COMPLETO DI INSERTI PER PROFILI 07 - 08 - 09.

D	d	Z	COD. SET
160	30	2	K411033000
160	31.75	2	K411033100
160	35	2	K411033500
160	40	2	K411034000
160	50*	2	K411035000

\* Senza mozzo / Without sleeve / Sans manchon / Sin casquillo / Ohne Spannbuchse.

ART.	D	COD.
K408 - B	160	K408160850
K411 - A**	160	K411A05000
K411 - D**	160	K411D05000
K411 - E	130	K411E05000

\*\* Senza inserti / Without inserts / Sans plaquettes / Sin cuchillas / Ohne Messer.



### ESEMPIO DI LAVORAZIONE.

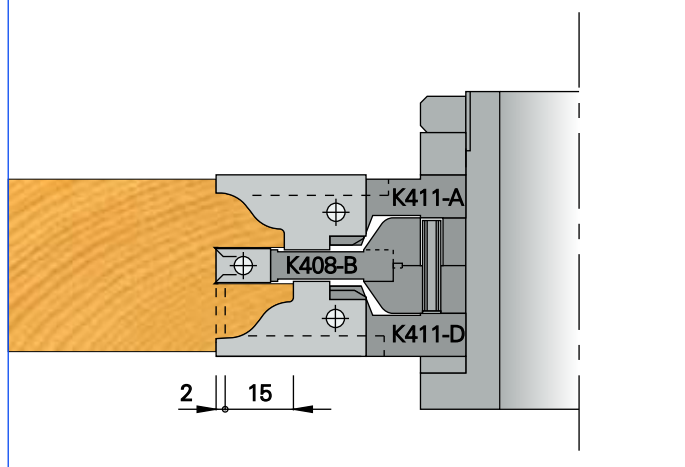
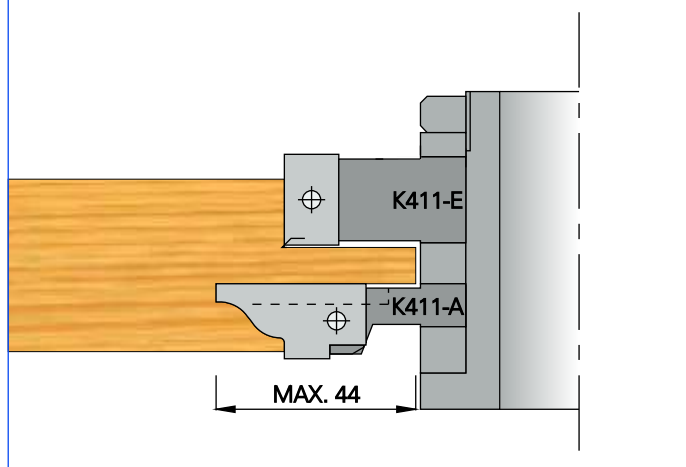

### Ricambi / Spare parts / Rechanges / Repuestos / Ersatzteile

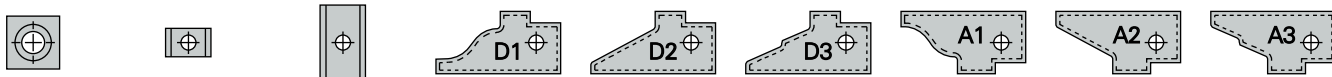

COD.	COD.	COD.	COD.	COD.	COD.	COD.	COD.	COD.	COD.
0480030014	0480050007	0480050020	K48011D100	K48011D200	K48011D300	K48011A100	K48011A200	K48011A300	

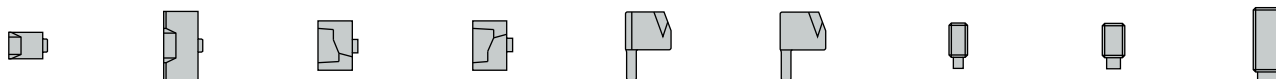

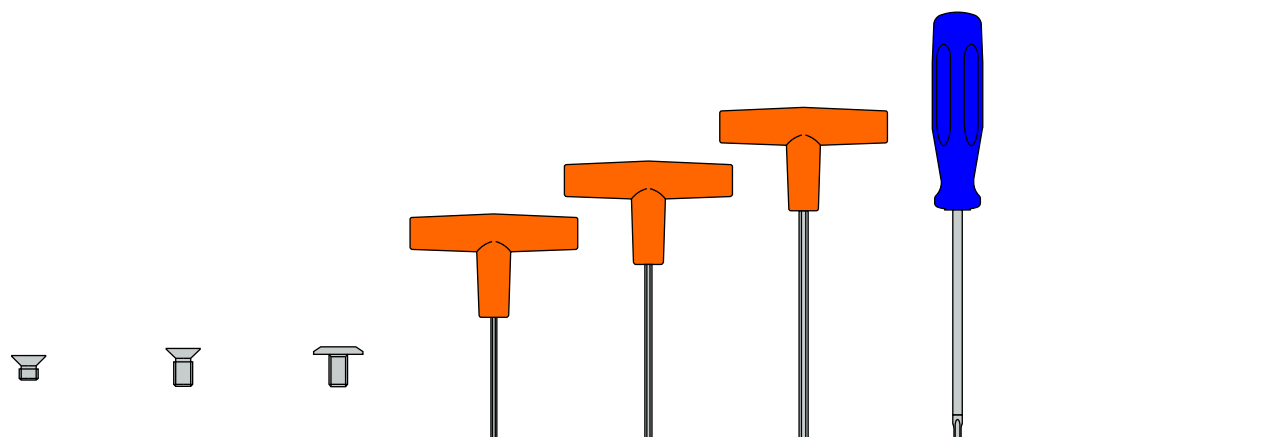

COD.	COD.	COD.	COD.	COD.	COD.	COD.	COD.	COD.	COD.
0480500700	0480501800	048053132R	048053132L	048060A000	048060C000	0480700512	0480700612	0480700820	



COD.	COD.	COD.	COD.	COD.	COD.	COD.	COD.
048074A507	048074A510	048073B000	0480782500	0480783000	048078L400	048078T200	

 Multiprofile cutter head set for internal doors.

 Juego de cabezales multiperfiles para puertas.

 Jeu de porte - outils multiprofiles pour portes.

 Multi - Profiler Messerkopfsatz für Innentüren.



**HW**

**MAN**

n 4800 - 8300

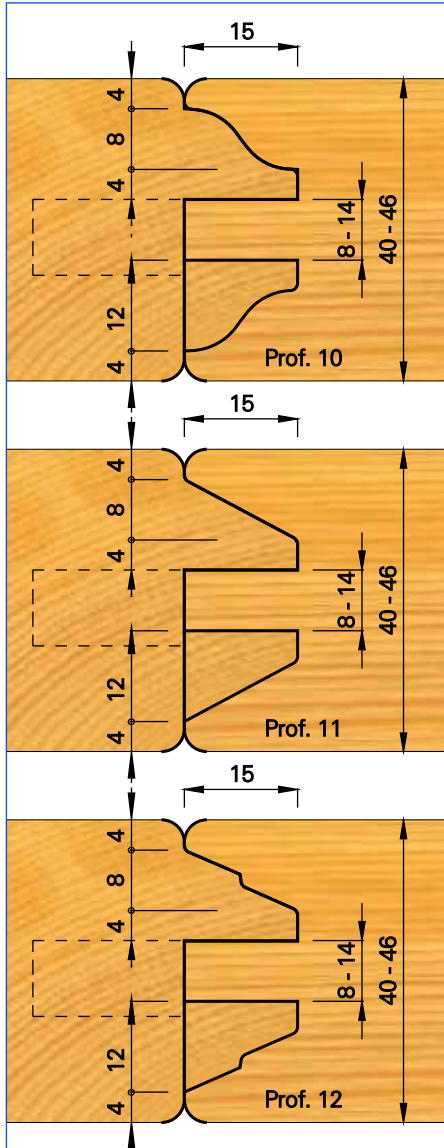
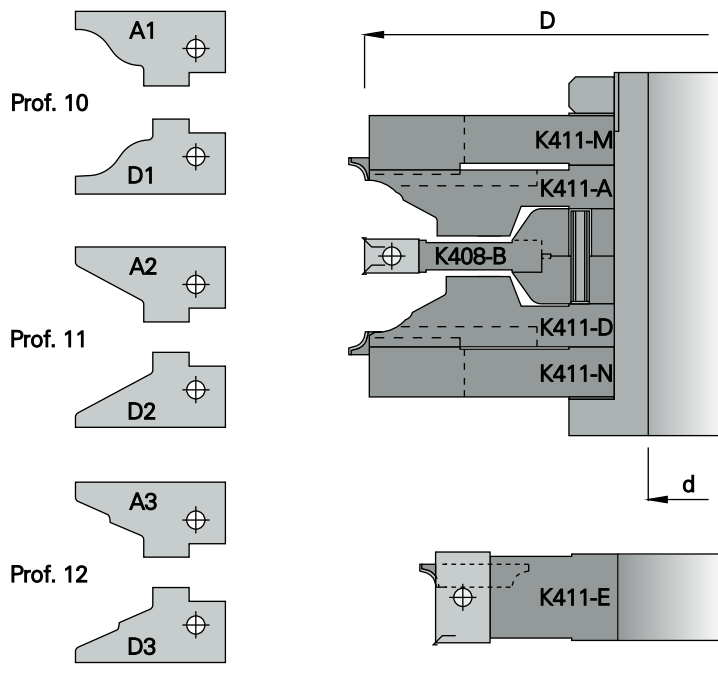

### SET COMPLETO DI INSERTI PER PROFILI 10 - 11- 12.

D	d	Z			
			COD.	COD.	COD.
160	30	2	K411043045	K4110430R1	K4110430R3
160	31.75	2	K411043145	K4110431R1	K4110431R3
160	35	2	K411043545	K4110435R1	K4110435R3
160	40	2	K411044045	K4110440R1	K4110440R3
160	50*	2	K411045045	K4110450R1	K4110450R3

\* Senza mozzo / Without sleeve / Sans manchon / Sin casquillo / Ohne Spannbuchse.

ART.	D			
		COD.	COD.	COD.
K408 - B	160	K408160850	K408160850	K408160850
K411 - A**	160	K411A05045	K411A050R1	K411A050R3
K411 - D**	160	K411D05000	K411D05000	K411D05000
K411 - E	130	K411E05045	K411E050R1	K411E050R3
K411 - M	160	K411M05045	K411M050R1	K411M050R3
K411 - N	160	K411N05045	K411N050R1	K411N050R3

\*\* Senza inserti / Without inserts / Sans plaquettes / Sin cuchillas / Ohne Messer.



### ESEMPIO DI LAVORAZIONE.

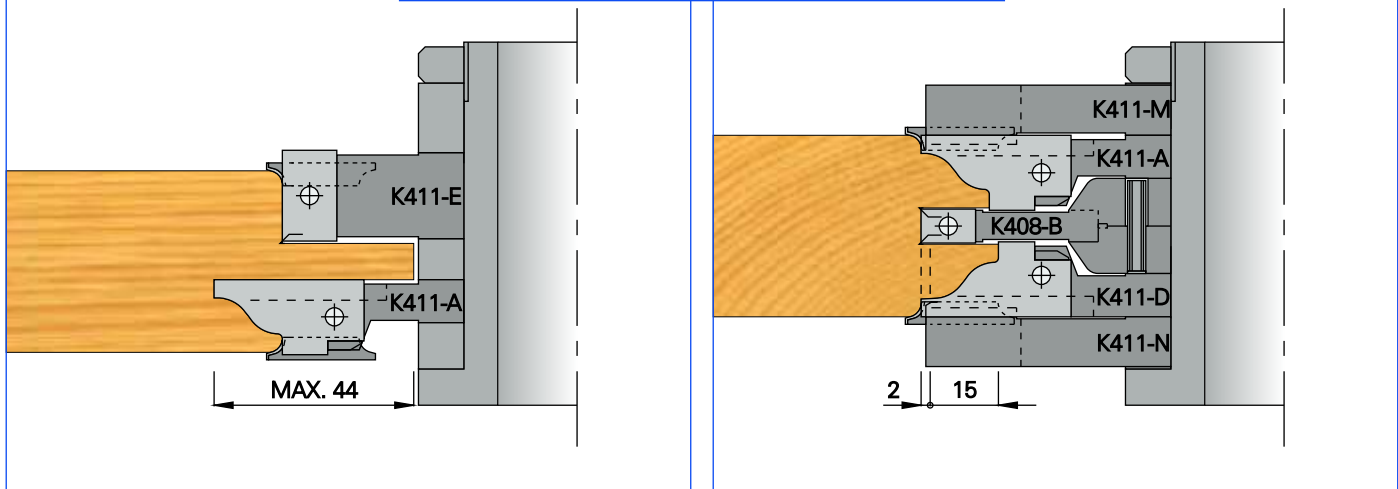

### Ricambi / Spare parts / Rechanges / Repuestos / Ersatzteile

COD.	COD.	COD.	COD.	COD.	COD.	COD.	COD.	COD.
0480030014	0480050007	0480050020	K48011D100	K48011D200	K48011D300	K48011A100	K48011A200	K48011A300
COD.	COD.	COD.	COD.	COD.	COD.	COD.	COD.	COD.
0480500700	0480501800	048053132R	048053132L	048060A000	048060C000	0480700512	0480700612	0480700820
COD.	COD.	COD.	COD.	COD.	COD.	COD.		
048074A507	048074A510	048074B512	048074B515	048073B000	K480110000	K480120000		
COD.	COD.	COD.	COD.	COD.	COD.	COD.	COD.	
K480130000	K480140000	K480150000	K480160000	0480782500	0480783000	048078L400	048078T200	

Multiprofile cutter head set for internal doors.

Juego de cabezales multiperfiles para puertas.

Jeu de porte - outils multiprofiles pour portes.

Multi - Profiler Messerkopfsatz für Innentüren.





**HW**

**MAN**

D 140 n 5500 - 9500  
D 160 n 4800 - 8300

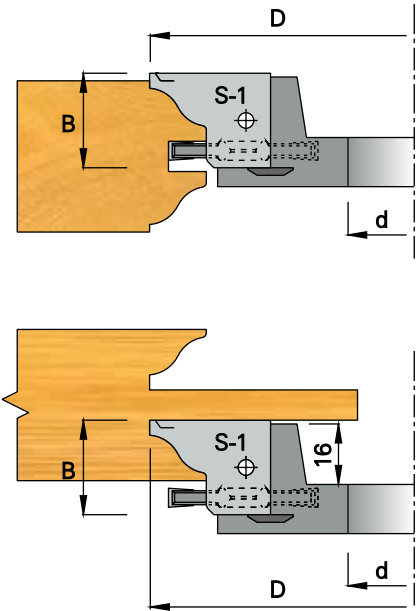
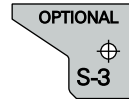
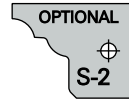
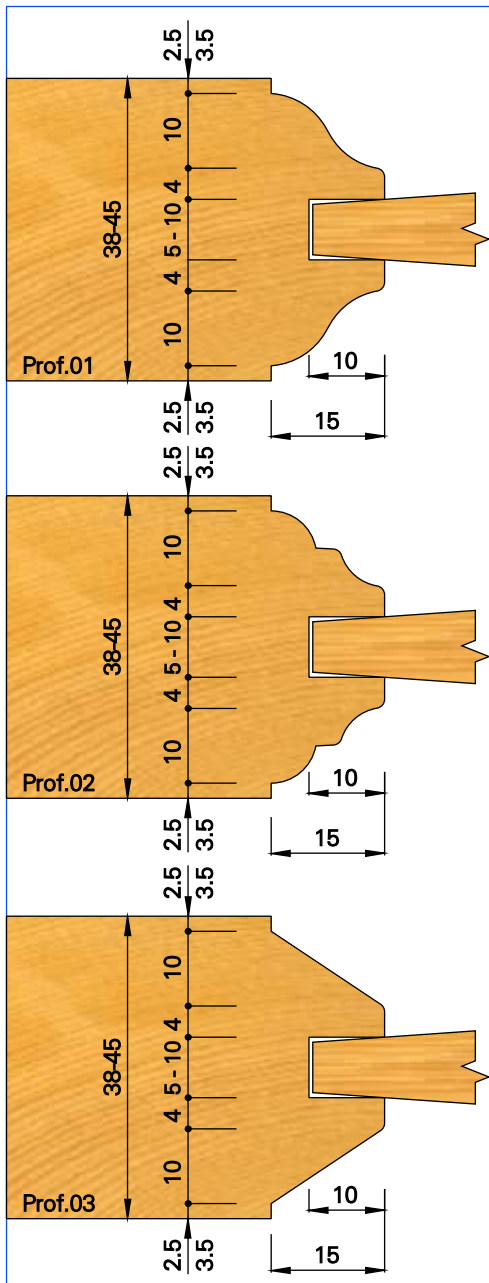

D	B	d	Z	V	COD.
140	25	30	2	2	K411S00030
140	25	31.75	2	2	K411S00031
140	25	35	2	2	K411S00035
160	25	40	2	2	K411S00040
160	25	50	2	2	K411S00050

### Ricambi / Spare parts / Rechanges / Repuestos / Ersatzteile



COD.

0480030014

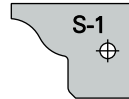

COD.

K48011S100

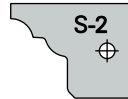

COD.

K48011S200

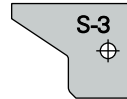

COD.

K48011S300



COD.

048053232R



COD.

0480700820

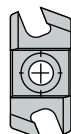

COD.

K48017F000



COD.

048074A510



COD.

048074C515



COD.

048073B000

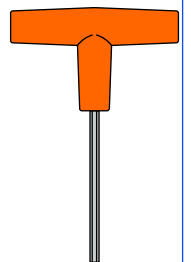

COD.

048078L400

Multi-profile cutter head for internal doors.

Cabezal multiperfiles para puertas.

Porte - outil multiprofiles pour portes.

Multi - Profiler Messerkopf für Innentüren.

**PROFILATURA: Coltelli HW intercambiabili con profili opzionali.**

 PROFILING: Interchangeable TC knives with optional profiles.

 PROFILAGE: Couteaux HW interchangeables avec profils optionnels.

 PERFILADURA: Cuchillas de HW intercambiables con perfiles opcionales.

 PROFILIERUNG: Austauschbare HW-Messer mit zusätzlichen Profilen.

**New  
generation**

**TENONATURA: Utensili con Ø284 o Ø320 per tenoni semplici e doppi**

 TENONING: Tool sets with Ø284 or Ø320 for single and double tenons

 TENONNAGE: Jeux de disques avec Ø284 ou Ø320 pour tenons simples et doubles.

 PARA ESPIGAR: Juego de cabezales de Ø284 o Ø320 para espigas simples o dobles.

 ZAPFEN: Zapfensätze mit Ø284 oder Ø320 für Einzel- und Doppelzapfen.

**REGOLAZIONI: Spessore legno e larghezza canale.**

 ADJUSTMENTS: Door thickness and groove width.

 REGLAGES: Epaisseur de la porte et largeur de la rainure.

 AJUSTES: Espesor de la puerta y ancho de la ranura.

 VESTELLUGEN: Tür-Dicke und Nut-Breite.



 Multi-profile cutter head set for internal doors.

 Juego de cabezales multiperfiles para puertas.

 Jeu de porte - outils multiprofiles pour portes.

 Multi - Profiler Messerkopfsatz für Innentüren.



**Ø 284**  
**TENONING SET**



**HW**

**MAN**

D 166 n 4500 - 7800  
D 284 n 2700 - 4600

### K 421 - 15

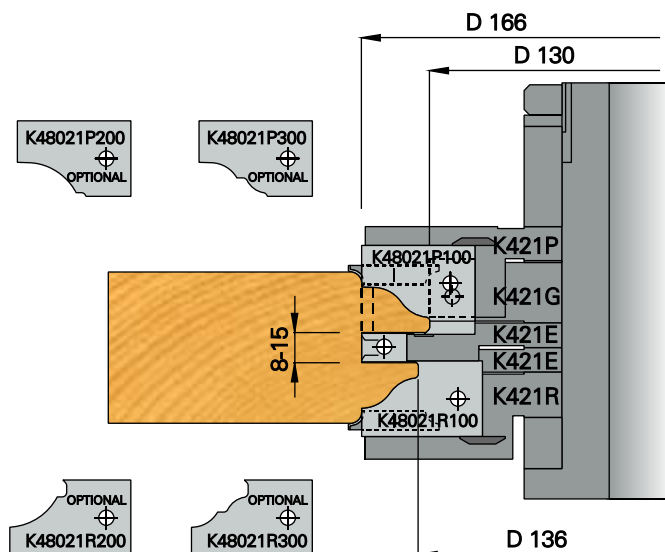

### K 422 - 15

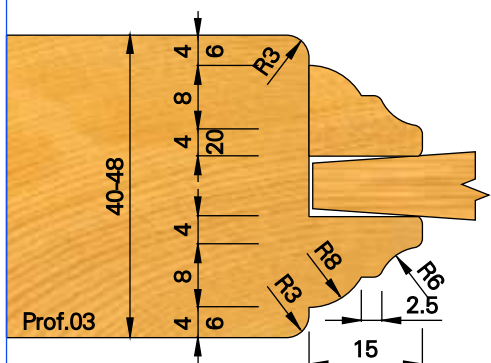
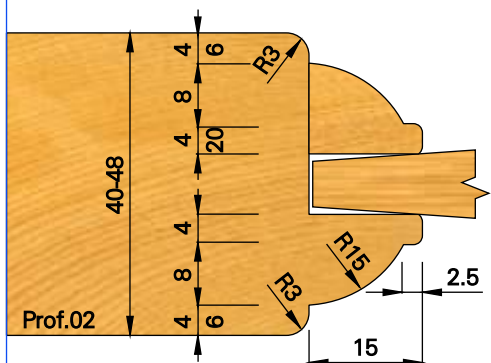
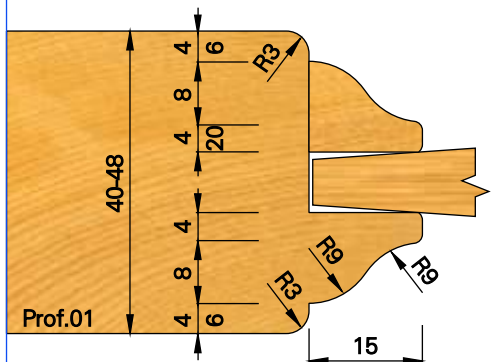
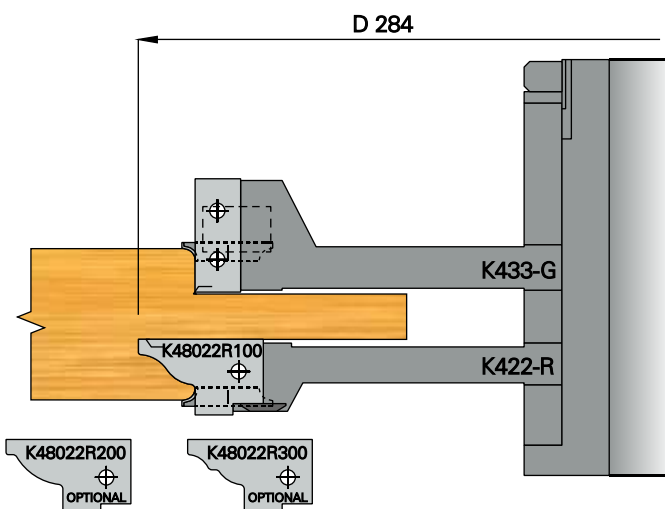

ART.	d	Z	COD.
K421 - 15	30	2	K4211530R3
K421 - 15	31.75	2	K4211531R3
K421 - 15	35	2	K4211535R3
K421 - 15	40	2	K4211540R3
K421 - 15	50	2	K4211550R3

ART.	d	Z	COD.
K422 - 15	30	4	K4221530R3
K422 - 15	31.75	4	K4221531R3
K422 - 15	35	4	K4221535R3
K422 - 15	40	4	K4221540R3
K422 - 15	50	4	K4221550R3

Multi-profile cutter head set for internal doors.

Juego de cabezales multiperfiles para puertas.

Jeu de porte - outils multiprofiles pour portes.

Multi - Profiler Messerkopfsatz für Innentüren.



**Ø 320**  
**TENONING SET**



**HW**

**MAN**

D 166 n 4500 - 7800  
D 320 n 2400 - 4100

### K 421 - 15

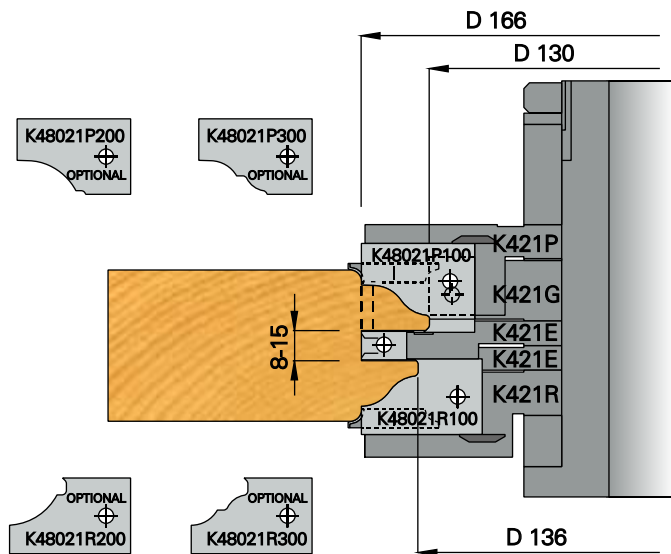

### K 422 - 22

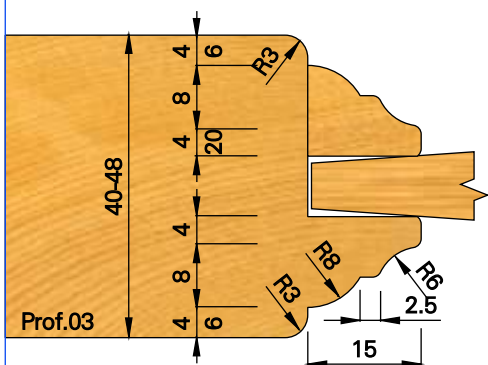
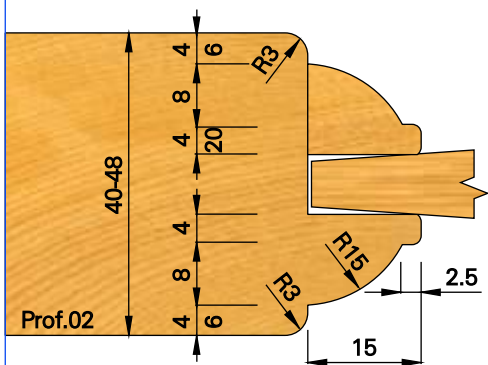
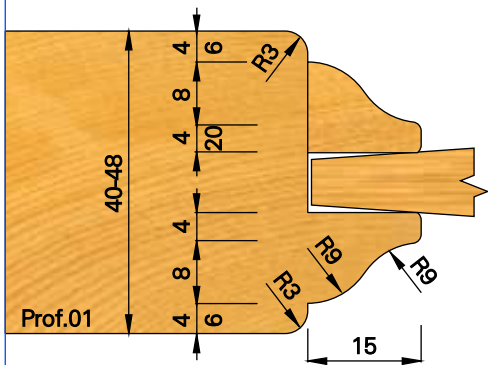
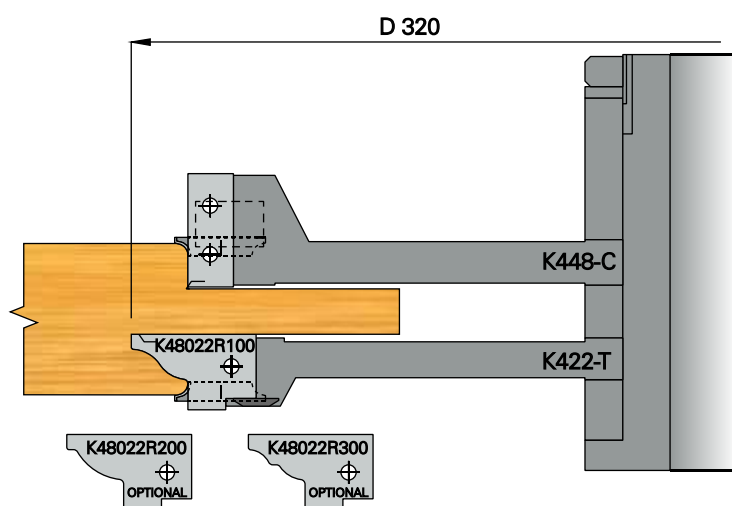

ART.	d	Z	COD.
K421 - 15	30	2	K4211530R3
K421 - 15	31.75	2	K4211531R3
K421 - 15	35	2	K4211535R3
K421 - 15	40	2	K4211540R3
K421 - 15	50	2	K4211550R3

ART.	d	Z	COD.
K422 - 22	30	4	K4222230R3
K422 - 22	31.75	4	K4222231R3
K422 - 22	35	4	K4222235R3
K422 - 22	40	4	K4222240R3
K422 - 22	50	4	K4222250R3

Multi-profile cutter head set for internal doors.

Juego de cabezales multiperfiles para puertas.

Jeu de porte - outils multiprofiles pour portes.

Multi - Profiler Messerkopfsatz für Innentüren.



**Ø 284**  
**TENONING SET**



**HW**

**MAN**

D 166 n 4500 - 7800  
D 284 n 2700 - 4600

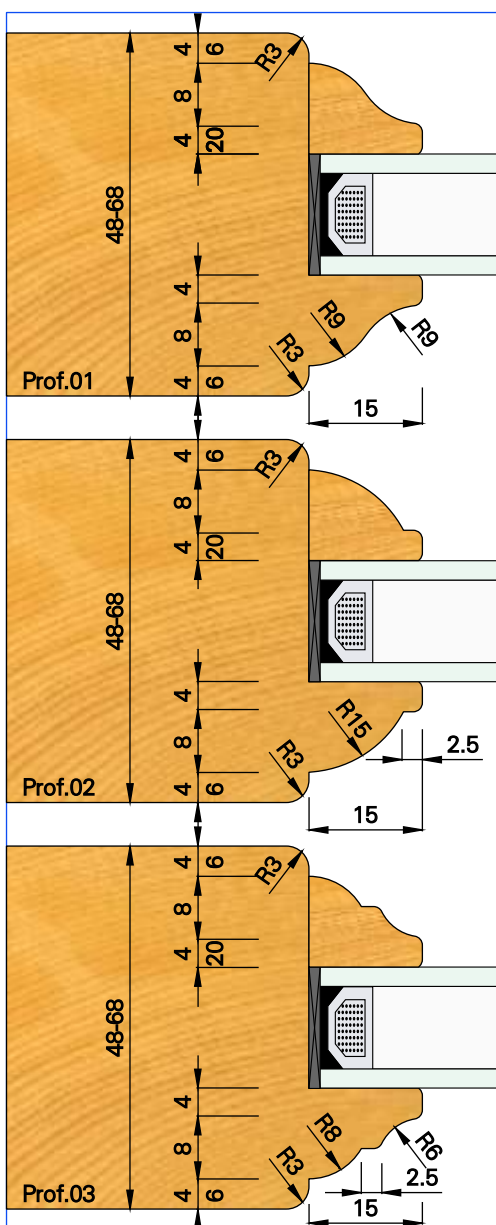

### K 421 - 23

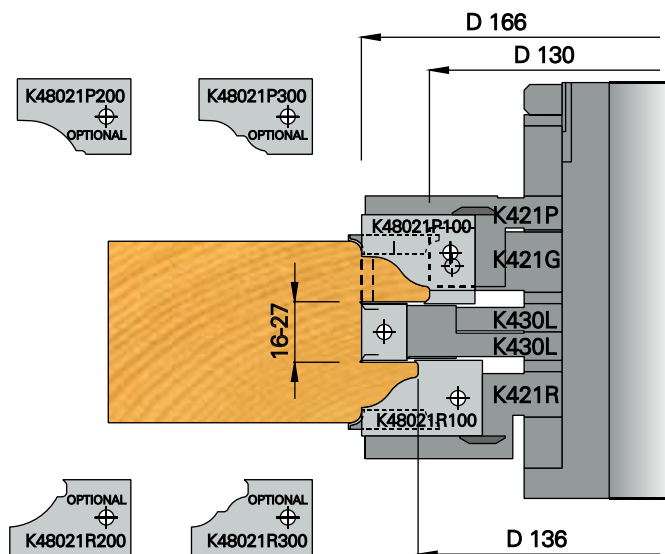

### K 422 - 17

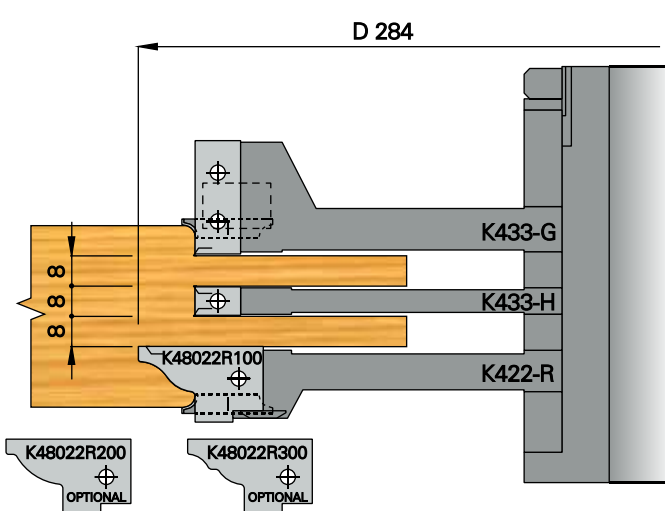

ART.	d	Z	COD.
K421 - 23	30	2	K4212330R3
K421 - 23	31.75	2	K4212331R3
K421 - 23	35	2	K4212335R3
K421 - 23	40	2	K4212340R3
K421 - 23	50	2	K4212350R3

ART.	d	Z	COD.
K422 - 17	30	4	K4221730R3
K422 - 17	31.75	4	K4221731R3
K422 - 17	35	4	K4221735R3
K422 - 17	40	4	K4221740R3
K422 - 17	50	4	K4221750R3



Multi-profile cutter head set for windows and front doors.



Juego de cabezales multiperfiles para ventanas y puertas.



Jeu de porte - outils multiprofiles pour fenêtres et portes.



Multi - Profiler Messerkopfsatz für Fenster und Aussentüren.



**Ø 320**  
**TENONING SET**



**HW**

**MAN**

D 166 n 4500 - 7800  
D 320 n 2400 - 4100

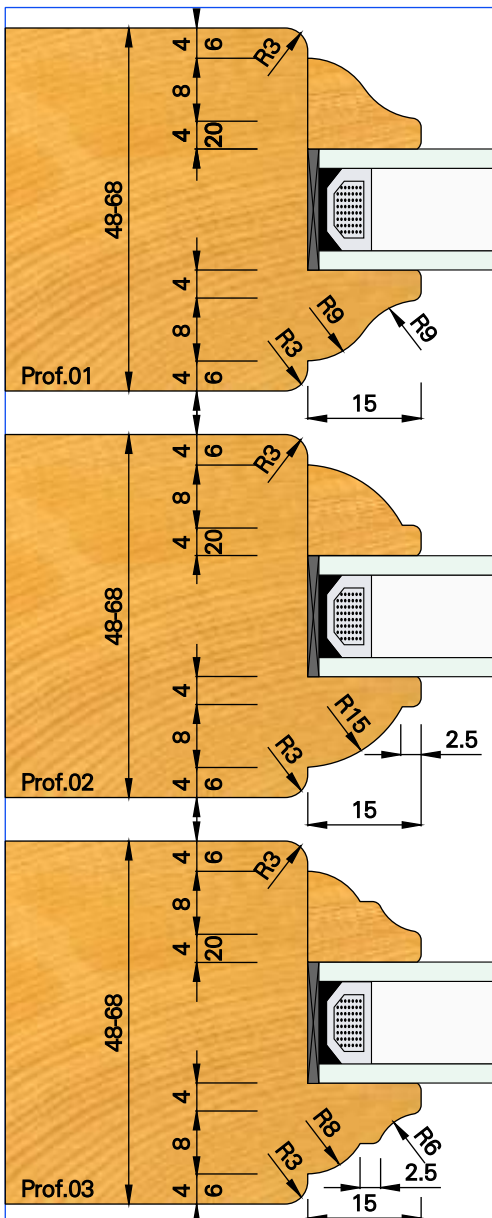

### K 421 - 23

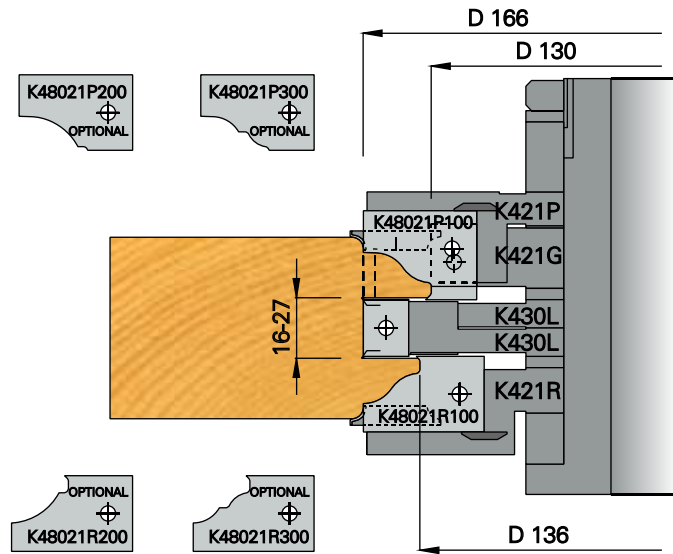

### K 422 - 23

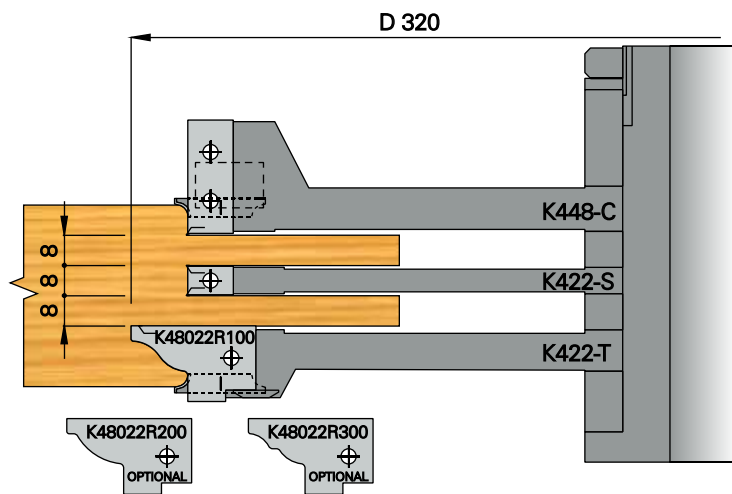

ART.	d	Z	COD.
K421 - 23	30	2	K4212330R3
K421 - 23	31.75	2	K4212331R3
K421 - 23	35	2	K4212335R3
K421 - 23	40	2	K4212340R3
K421 - 23	50	2	K4212350R3

ART.	d	Z	COD.
K422 - 23	30	4	K4222330R3
K422 - 23	31.75	4	K4222331R3
K422 - 23	35	4	K4222335R3
K422 - 23	40	4	K4222340R3
K422 - 23	50	4	K4222350R3

Multi-profile cutter head set for windows and front doors.

Juego de cabezales multiperfiles para ventanas y puertas.

Jeu de porte - outils multiprofiles pour fenêtres et portes.

Multi - Profiler Messerkopfsatz für Fenster und Aussentüren.



**Ø 284**  
**TENONING SET**

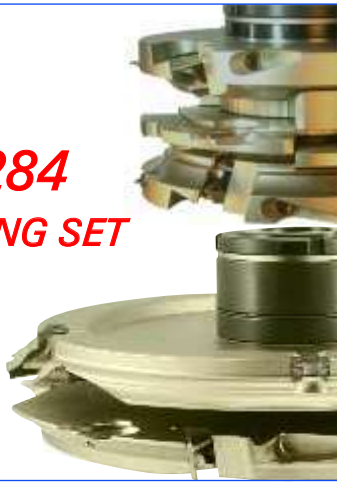

**HW**

**MAN**

D 166 n 4500 - 7800  
D 284 n 2700 - 4600

### K 421 - 25

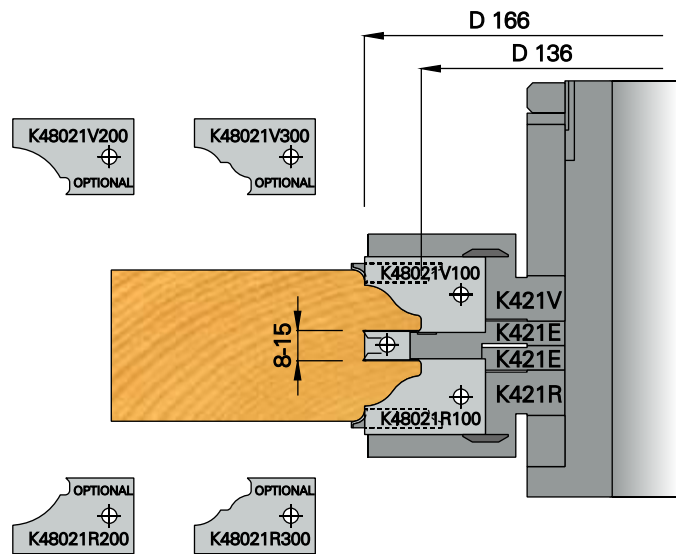

### K 422 - 25

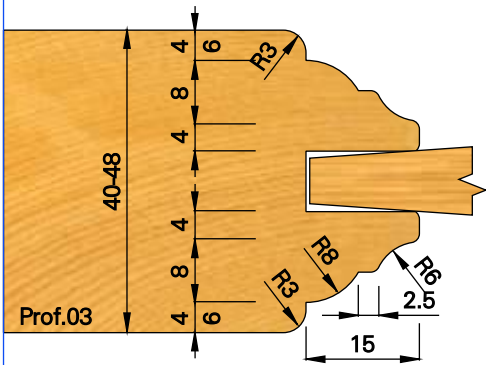
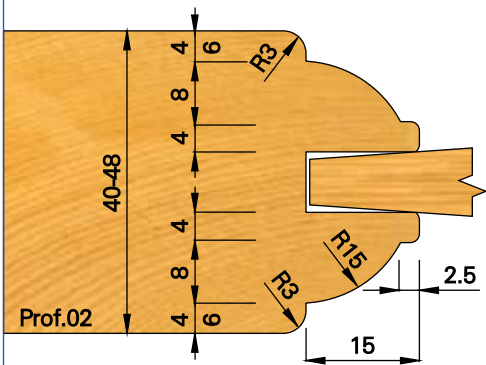
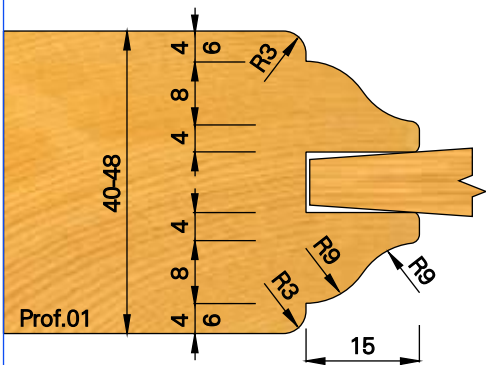
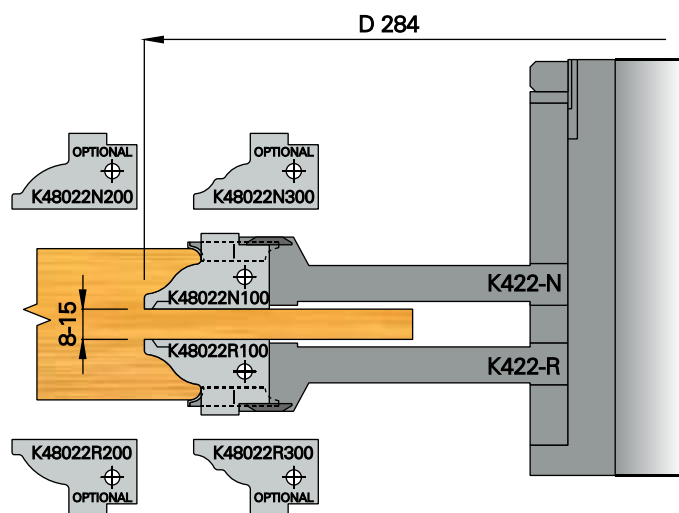

ART.	d	Z	COD.
K421 - 25	30	2	K4212530R3
K421 - 25	31.75	2	K4212531R3
K421 - 25	35	2	K4212535R3
K421 - 25	40	2	K4212540R3
K421 - 25	50	2	K4212550R3

ART.	d	Z	COD.
K422 - 25	30	4	K4222530R3
K422 - 25	31.75	4	K4222531R3
K422 - 25	35	4	K4222535R3
K422 - 25	40	4	K4222540R3
K422 - 25	50	4	K4222550R3

 Multi-profile cutter head set for internal doors.

 Juego de cabezales multiperfiles para puertas.

 Jeu de porte - outils multiprofiles pour portes.

 Multi - Profiler Messerkopfsatz für Innentüren.



**Ø 320**  
**TENONING SET**



**HW**

**MAN**

D 166 n 4500 - 7800  
D 320 n 2400 - 4100

### K 421 - 25

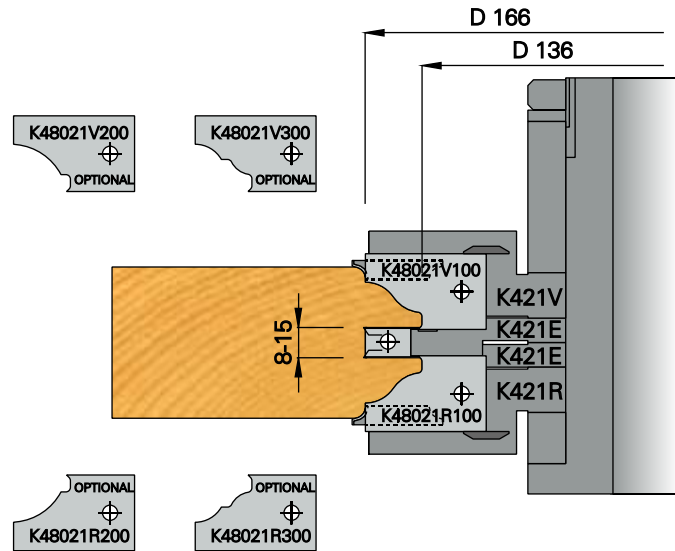

### K 422 - 27

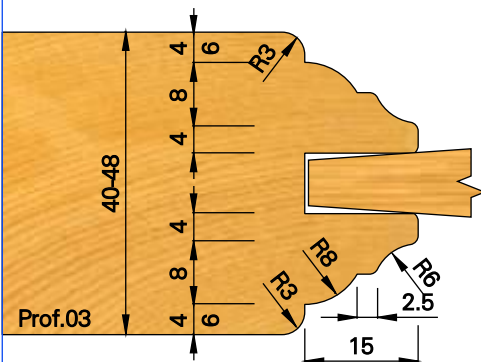
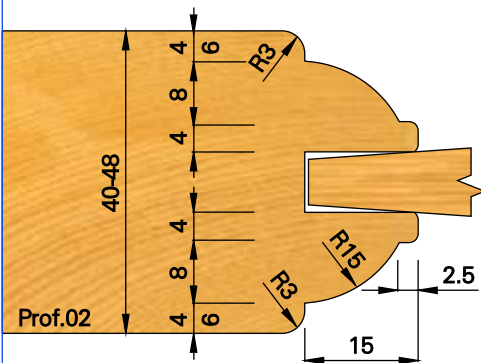
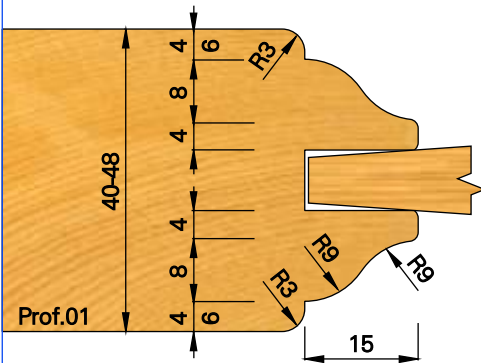
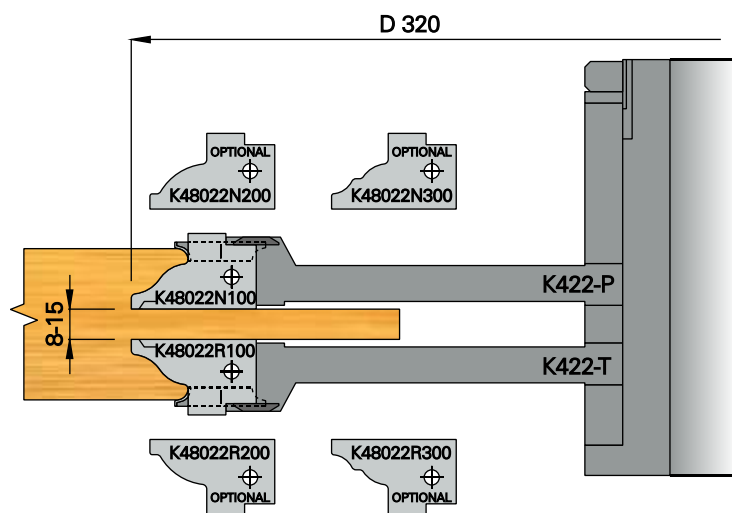

ART.	d	Z	COD.
K421 - 25	30	2	K4212530R3
K421 - 25	31.75	2	K4212531R3
K421 - 25	35	2	K4212535R3
K421 - 25	40	2	K4212540R3
K421 - 25	50	2	K4212550R3

ART.	d	Z	COD.
K422 - 27	30	4	K4222730R3
K422 - 27	31.75	4	K4222731R3
K422 - 27	35	4	K4222735R3
K422 - 27	40	4	K4222740R3
K422 - 27	50	4	K4222750R3

Multi-profile cutter head set for internal doors.

Juego de cabezales multiperfiles para puertas.

Jeu de porte - outils multiprofiles pour portes.

Multi - Profiler Messerkopfsatz für Innentüren.



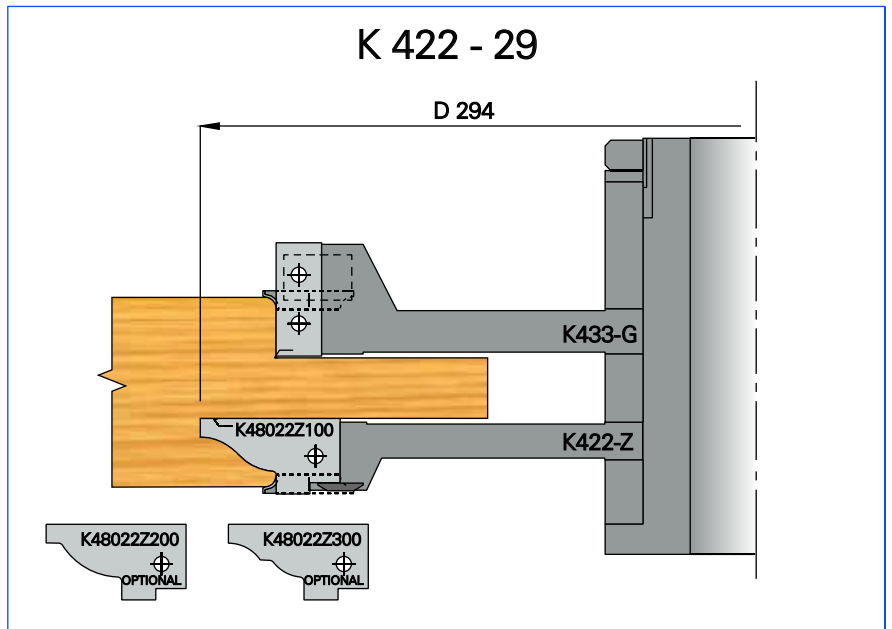
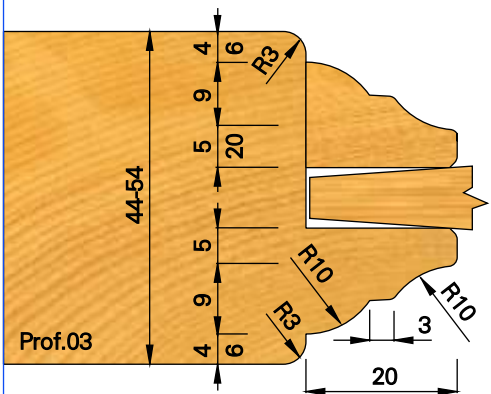
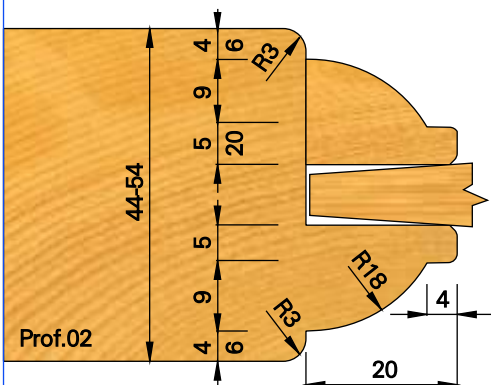
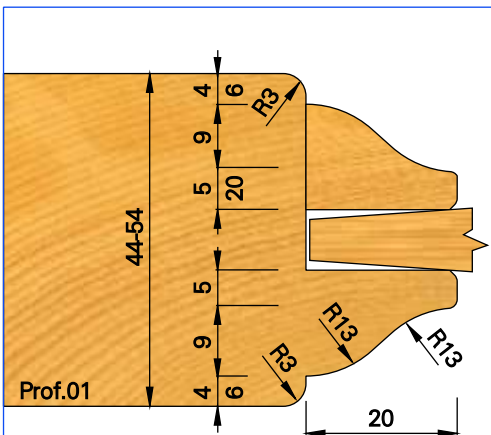
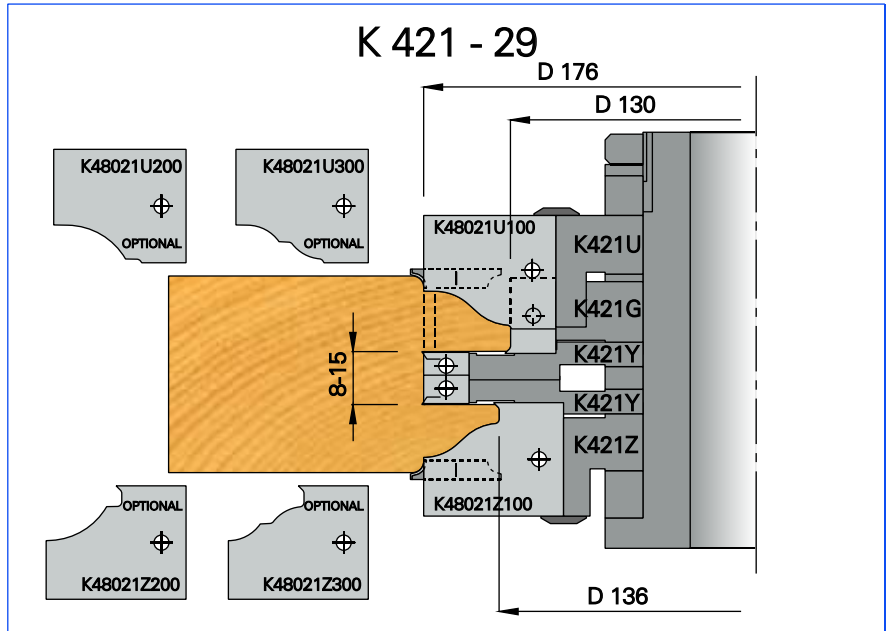
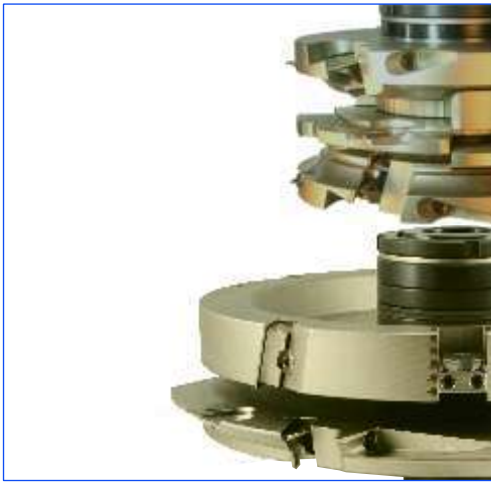

**HW**

**MAN**

D 176 n 4300 - 7400  
D 294 n 2800 - 4500

ART.	d	Z	COD.
K421 - 29	30	2	K4212930R3
K421 - 29	31.75	2	K4212931R3
K421 - 29	35	2	K4212935R3
K421 - 29	40	2	K4212940R3
K421 - 29	50	2	K4212950R3

ART.	d	Z	COD.
K422 - 29	30	4	K4222930R3
K422 - 29	31.75	4	K4222931R3
K422 - 29	35	4	K4222935R3
K422 - 29	40	4	K4222940R3
K422 - 29	50	4	K4222950R3



Multi-profile cutter head set for windows and front doors.



Juego de cabezales multiperfiles para ventanas y puertas.



Jeu de porte - outils multiprofiles pour fenêtrés et portes.



Multi - Profiler Messerkopfsatz für Fenster und Aussentüren.

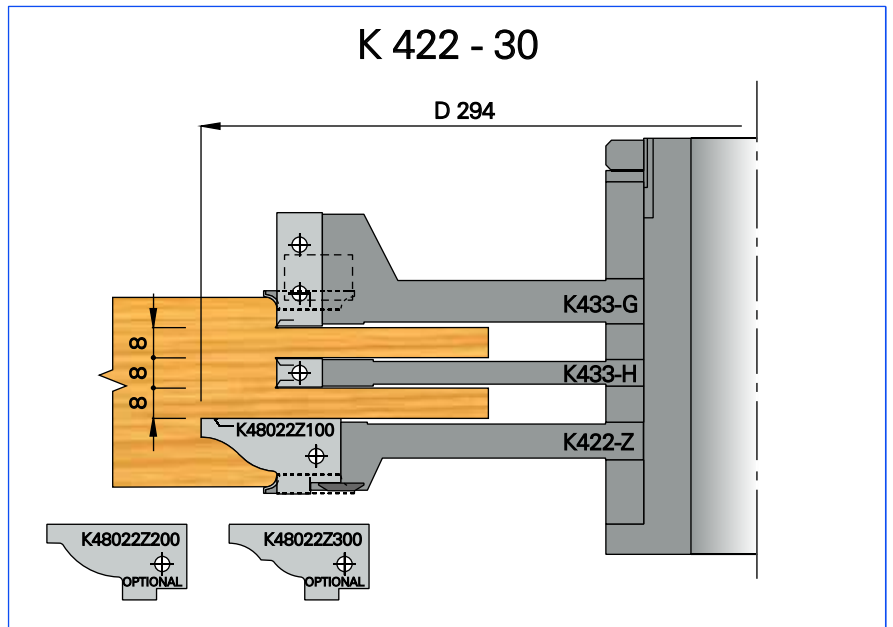
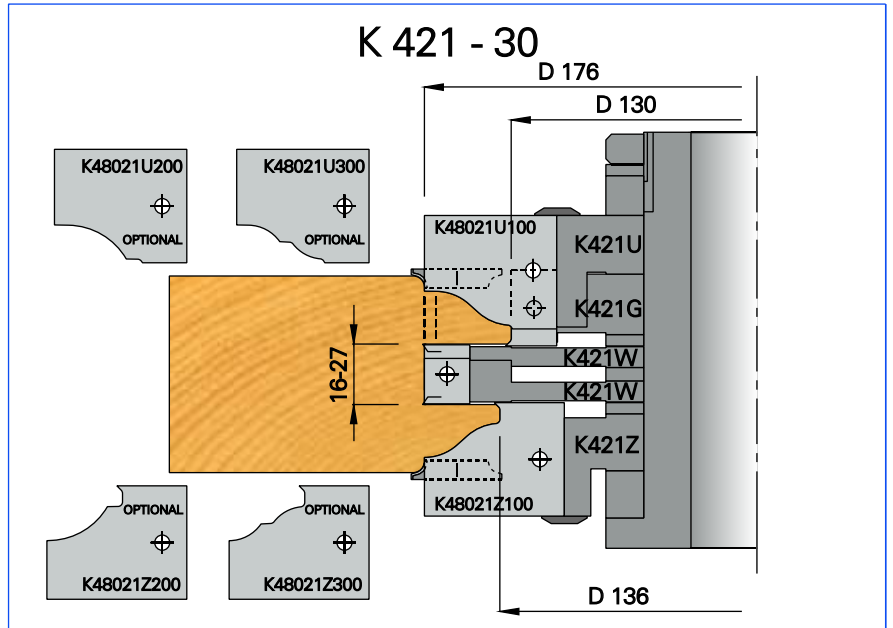
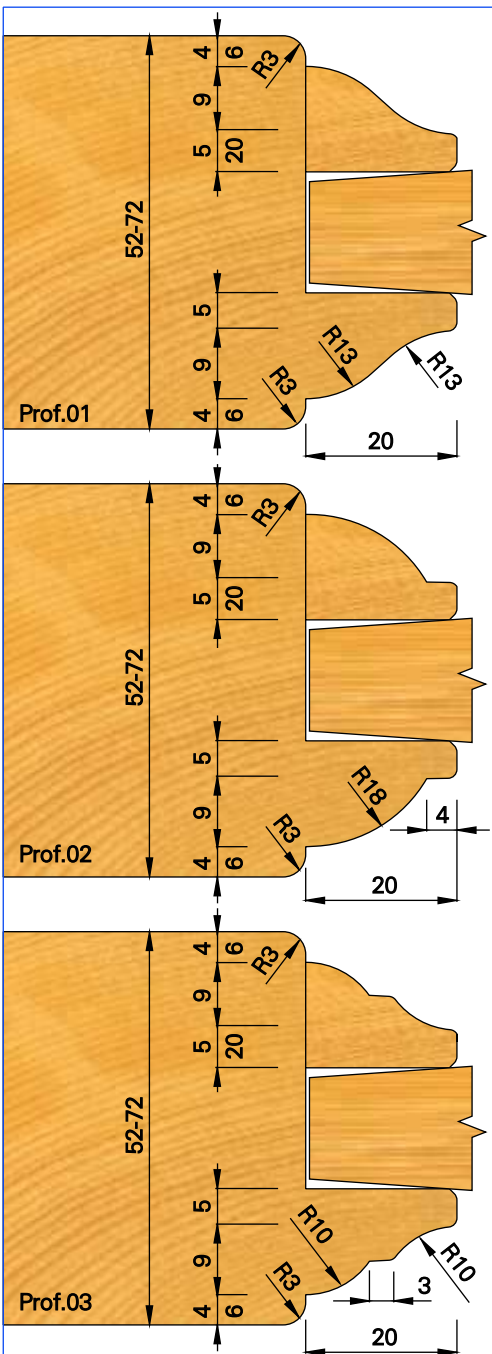

HW

MAN

D 176 n 4300 - 7400  
D 294 n 2800 - 4500

ART.	d	Z	COD.
K421 - 30	30	2	K4213030R3
K421 - 30	31.75	2	K4213031R3
K421 - 30	35	2	K4213035R3
K421 - 30	40	2	K4213040R3
K421 - 30	50	2	K4213050R3

ART.	d	Z	COD.
K422 - 30	30	4	K4223030R3
K422 - 30	31.75	4	K4223031R3
K422 - 30	35	4	K4223035R3
K422 - 30	40	4	K4223040R3
K422 - 30	50	4	K4223050R3

Multi-profile cutter head set for windows and front doors.

Juego de cabezales multiperfiles para ventanas y puertas.

Jeu de porte - outils multiprofiles pour fenêtrés et portes.

Multi - Profiler Messerkopfsatz für Fenster und Aussentüren.

# Ricambi per K421 - K422



COD. 0480030014	COD. 0480050007	COD. 0480050015	COD. 0480050030	COD. K48021G000	COD. K48021P100	COD. K48021P200	COD. K48021P300
COD. K48021R100	COD. K48021R200	COD. K48021R300	COD. K48022R100	COD. K48022R200	COD. K48022R300	COD. K48021V100	COD. K48021V200
COD. K48021V300	COD. K48022N100	COD. K48022N200	COD. K48022N300	COD. K48021U100	COD. K48021U200	COD. K48021U300	COD. K48021Z100
COD. K48021Z200	COD. K48021Z300	COD. K48022Z100	COD. K48022Z200	COD. K48022Z300	COD. 0480500700	COD. 0480501300	COD. 0480502600
COD. 048053132R	COD. 048053132L	COD. 048053282R	COD. 048053282L	COD. 048060A000	COD. 048060C000	COD. 0480700512	COD. 0480700612
COD. 0480700620	COD. 0480700820	COD. 048074A507	COD. 048074A510	COD. 048074B512	COD. 048074B515	COD. 048073B000	COD. K48062E000
COD. K480150000	COD. K480160000	COD. 0480782500	COD. 0480783000	COD. 048078L400	COD. 048078T200		

Spare parts for K421 - K422.

Repuestos para K421 - K422.

Rechanges pour K421 - K422.

Ersatzteile K421 - K422.

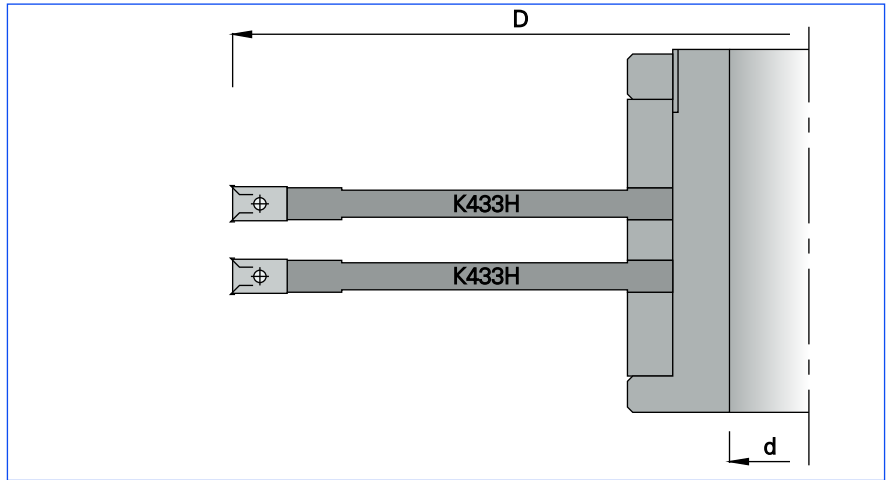

**HW**







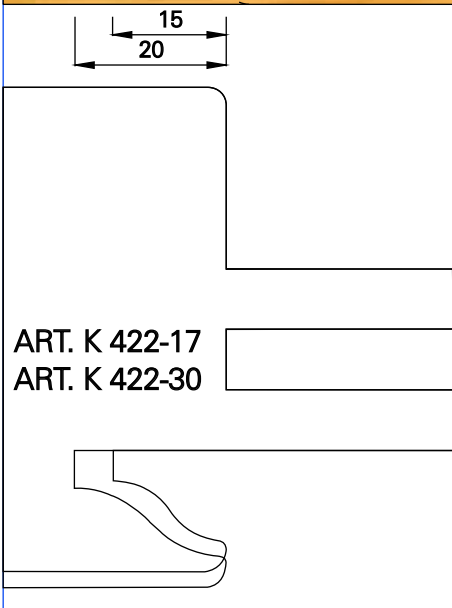
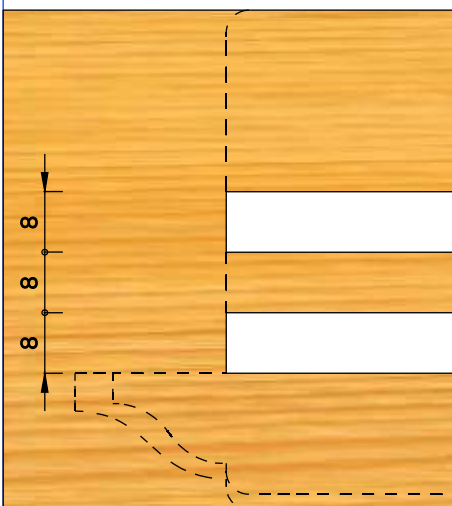

**MAN**

n 3000 - 5200

D	d	Z	COD.
254	30	4	K432063000
254	31.75	4	K432063100
254	35	4	K432063500
254	40	4	K432064000
254	50	4	K432065000

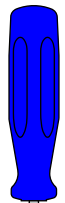

### Ricambi / Spare parts / Rechanges / Repuestos / Ersatzteile

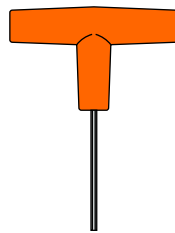
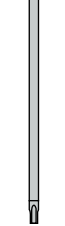
				
COD.	COD.	COD.		
0480030014	0480050007	0480500700		
				
COD.	COD.	COD.	COD.	COD.
048060A000	0480700512	048074A507	0480782500	048078T200

 Tenoning cutter head set.

 Juego de cabezales para espigar.

 Jeu de porte - outils à tenonner.

 Messerkopfsatz für Zapfenprofil.

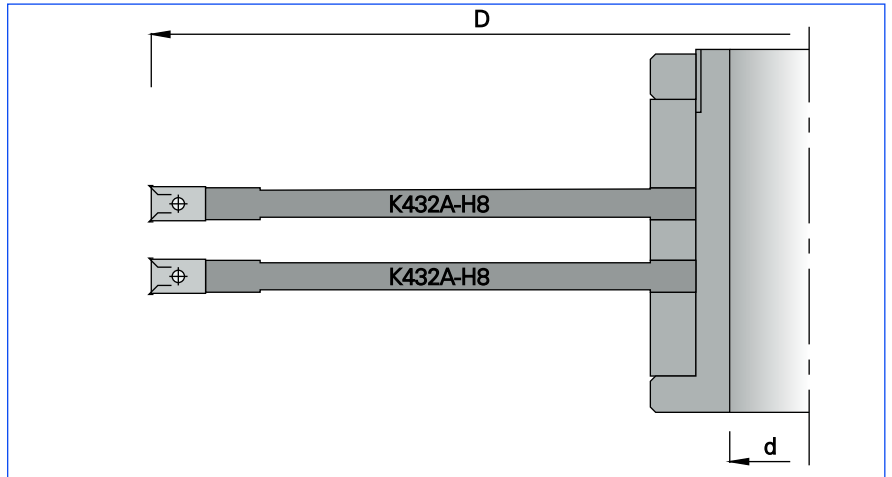

**HW**

**MAN**

n 2700 - 4600

D	d	Z	COD.
290	30	4	K432243000
290	31.75	4	K432243100
290	35	4	K432243500
290	40	4	K432244000
290	50	4	K432245000

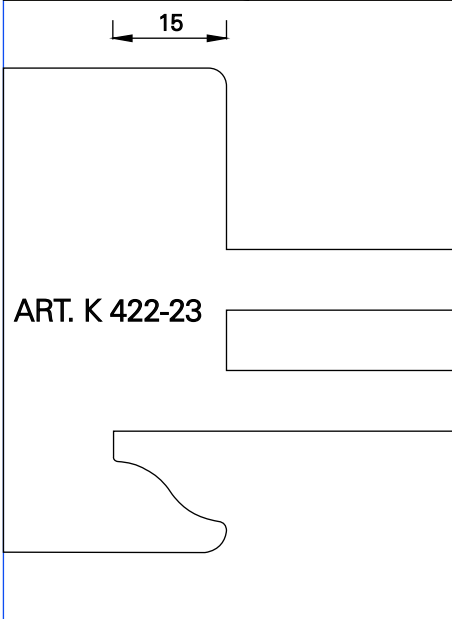
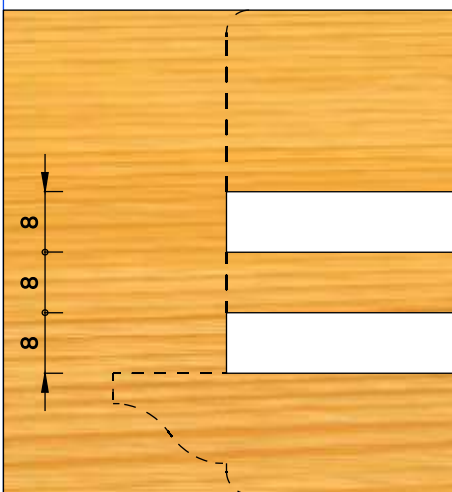

### Ricambi / Spare parts / Rechanges / Repuestos / Ersatzteile



COD.

0480030014



COD.

0480050007



COD.

0480500700



COD.

048060A000



COD.

0480700512



COD.

048074A507

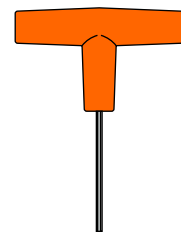

COD.

0480782500

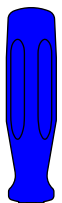

COD.

048078T200



Tenoning cutter head set.



Juego de cabezales para espigar.



Jeu de porte - outils à tenonner.



Messerkopfsatz für Zapfenprofil.

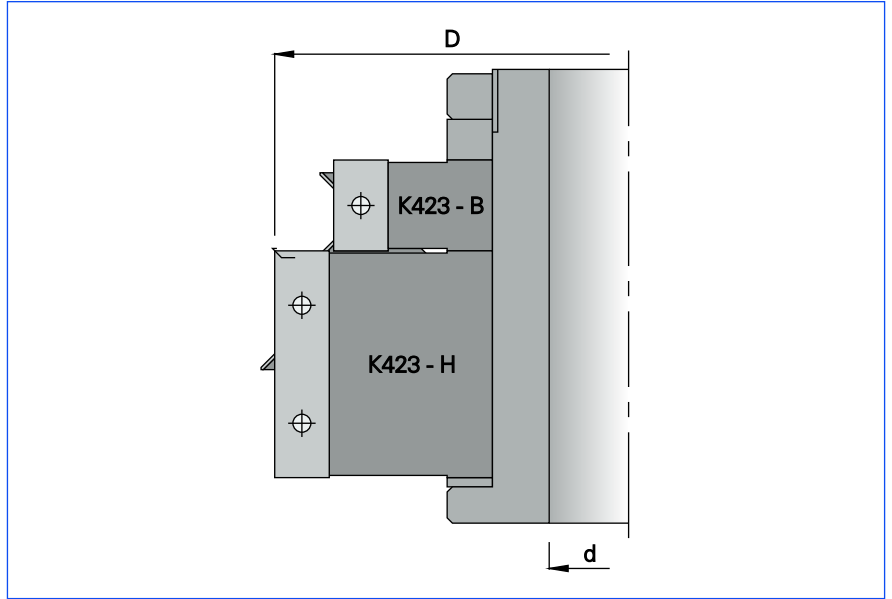

**HW** **MAN**

n 5000 - 8600

D	d	Z	COD.	COD.	COD.	COD.
156	30	2	K423023000	K423023045	K4230230R1	K4230230R3
156	31.75	2	K423023100	K423023145	K4230231R1	K4230231R3
156	35	2	K423023500	K423023545	K4230235R1	K4230235R3
156	40	2	K423024000	K423024045	K4230240R1	K4230240R3
156	50	2	K423025000	K423025045	K4230250R1	K4230250R3

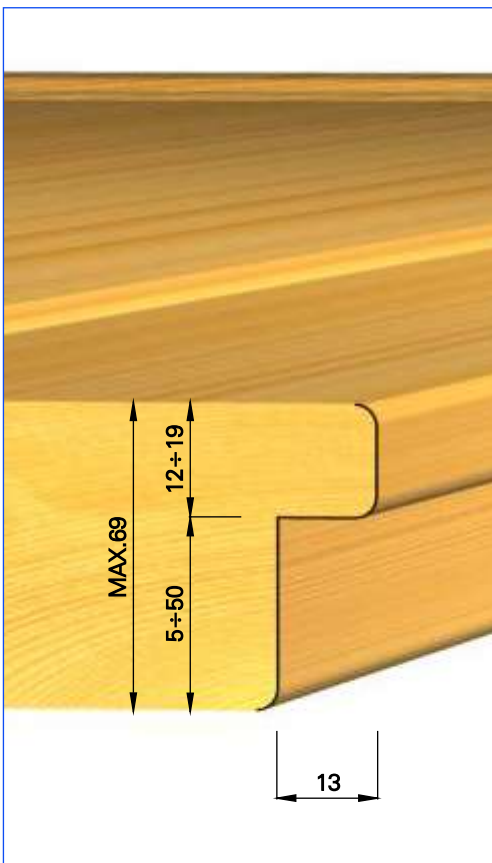

Ricambi / Spare parts / Rechanges / Repuestos / Ersatzteile

COD.	COD.	COD.	COD.	COD.	COD.
0480030014	0480050020	0480050050	0480501800	0480504600	
COD.	COD.	COD.	COD.	COD.	COD.
048060C000	0480700612	0480700620	048074A510		
COD.	COD.	COD.	COD.	COD.	COD.
048074B515	048073B000	K48062E000		0480783000	048078T200
COD.	COD.	COD.	COD.	COD.	COD.
K480110000	K480120000	K480130000	K480140000	K480150000	K480160000

	Door rebating cutter head set.		Juego de cabezales para perfil exterior de puertas.
	Jeu de porte - outils pour calibrage de portes.		Messerkopfsatz für Türenaussenprofil.

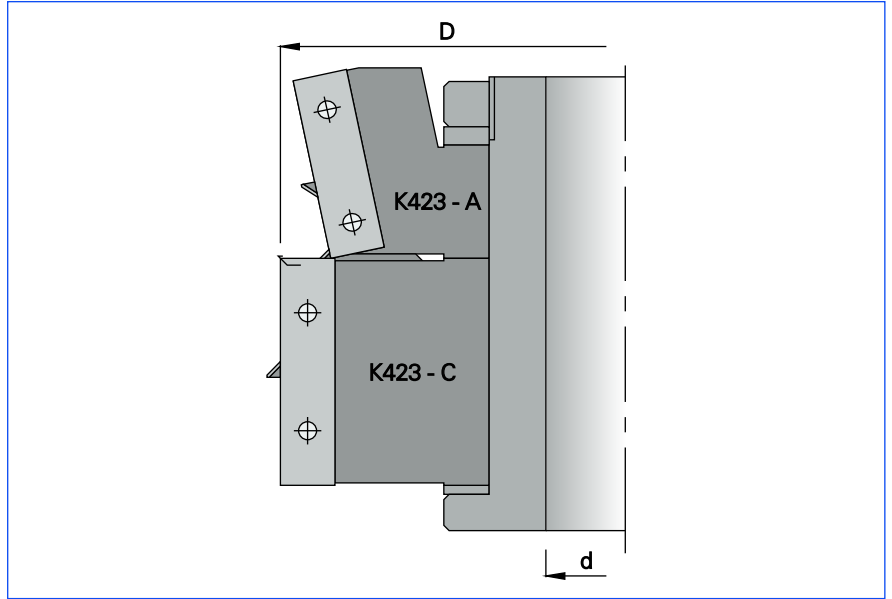

**HW**

**MAN**

n 5100 - 8900

D	d	Z	COD.	COD.	COD.	COD.
152	30	2	K423063000	K423063045	K4230630R1	K4230630R3
152	31.75	2	K423063100	K423063145	K4230631R1	K4230631R3
152	35	2	K423063500	K423063545	K4230635R1	K4230635R3
152	40	2	K423064000	K423064045	K4230640R1	K4230640R3
152	50	2	K423065000	K423065045	K4230650R1	K4230650R3

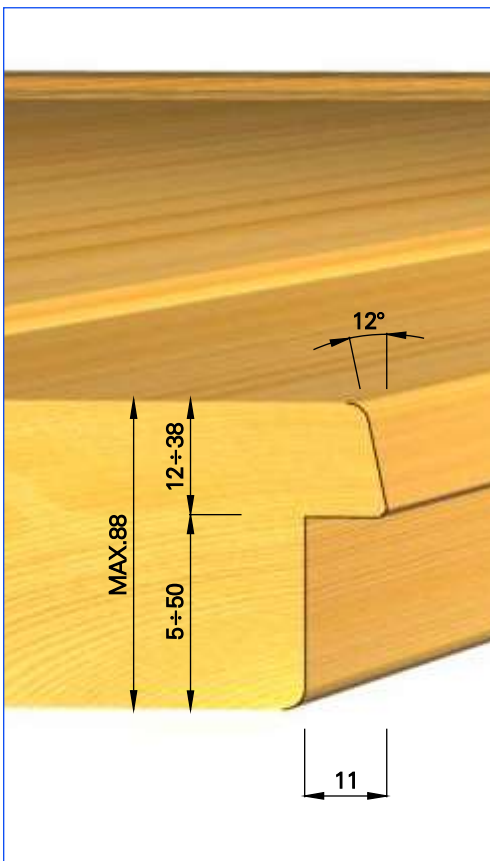

**Ricambi / Spare parts / Rechanges / Repuestos / Ersatzteile**

COD.	COD.	COD.	COD.	COD.	COD.
0480030014	0480050040	0480050050	0480503600	0480504600	
COD.	COD.	COD.	COD.	COD.	COD.
048060C000	0480700612	0480700620	048074A510		
COD.	COD.	COD.	COD.	COD.	COD.
048074B515	048073B000	K48062E000		0480783000	048078T200
COD.	COD.	COD.	COD.	COD.	COD.
K480110000	K480120000	K480130000	K480140000	K480150000	K480160000

Door rebating cutter head set.

Juego de cabezales para perfil exterior de puertas.

Jeu de porte - outils pour calibrage de portes.

Messerkopfsatz für Türenaussenprofil.

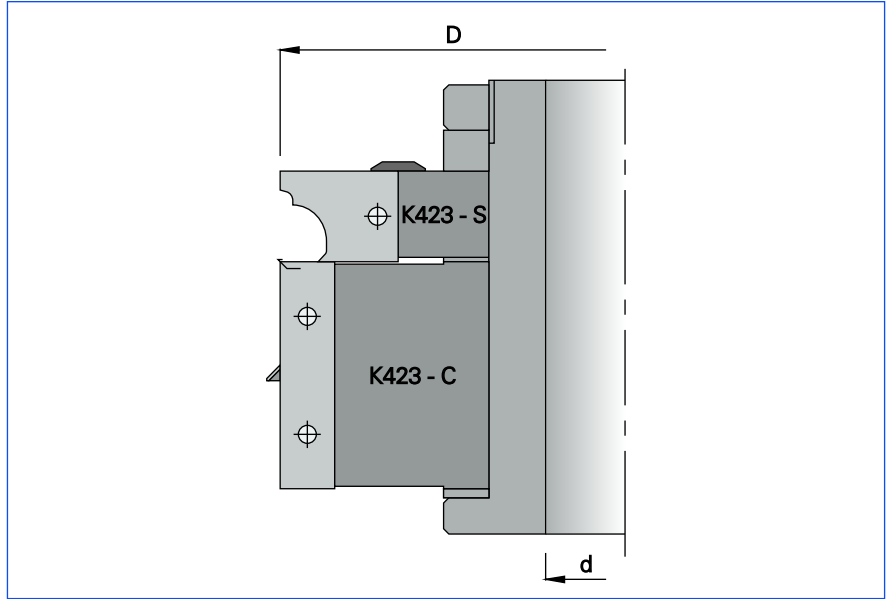

**HW**

**MAN**

n 5100 - 8900

D	d	Z	COD.	COD.	COD.	COD.
152	30	2	K423083000	K423083045	K4230830R1	K4230830R3
152	31.75	2	K423083100	K423083145	K4230831R1	K4230831R3
152	35	2	K423083500	K423083545	K4230835R1	K4230835R3
152	40	2	K423084000	K423084045	K4230840R1	K4230840R3
152	50	2	K423085000	K423085045	K4230850R1	K4230850R3

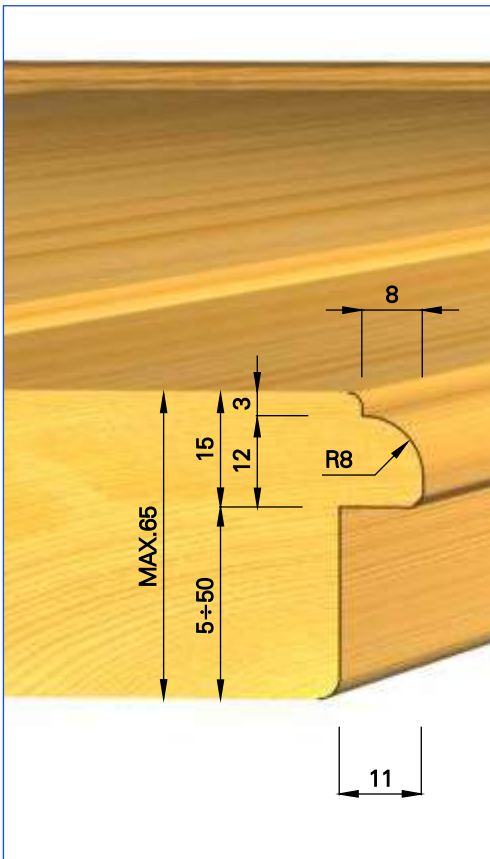

**Ricambi / Spare parts / Rechanges / Repuestos / Ersatzteile**

COD.	COD.	COD.	COD.	COD.	COD.
0480030014	0480050050	K48023S000	0480504600	0480521825	048060C000
COD.	COD.	COD.	COD.	COD.	COD.
0480700612	0480700620	0480700820	K48062E000		
COD.	COD.	COD.	COD.	COD.	COD.
048074A510	048074B515	048073B000			
COD.	COD.	COD.	COD.	COD.	COD.
K480120000	K480140000	K480160000	0480783000	048078L400	048078T200

Door rebating cutter head set.

Juego de cabezales para perfil exterior de puertas.

Jeu de porte - outils pour calibrage de portes.

Messerkopfsatz für Türenaussenprofil.



# K 449 Gruppo di teste per la squadratura delle porte



HW

MAN

n 4400 - 7600

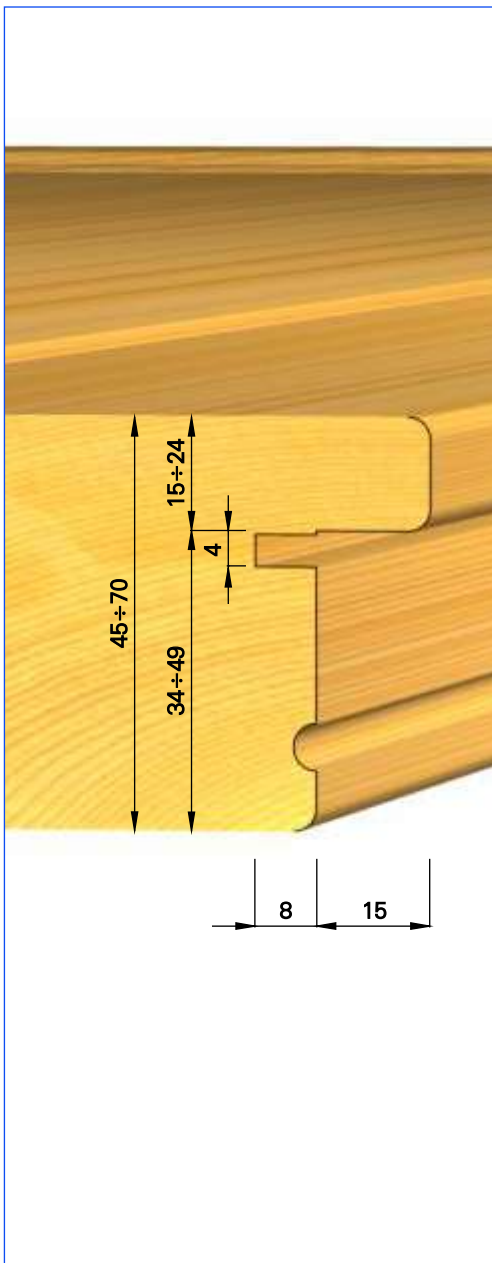
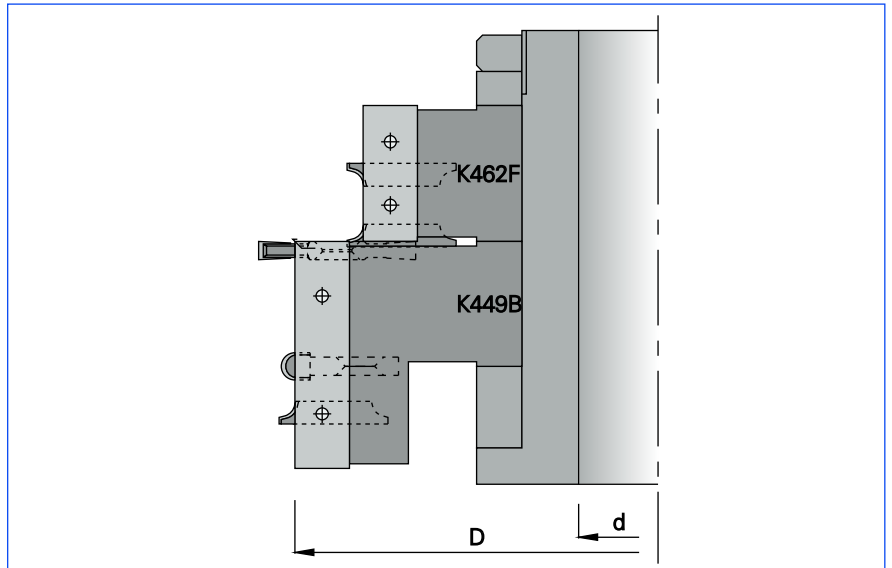

D	d	Z	COD.	COD.	COD.	COD.
160	30	2	K449003000	K449003045	K4490030R1	K4490030R3
160	31.75	2	K449003100	K449003145	K4490031R1	K4490031R3
160	35	2	K449003500	K449003545	K4490035R1	K4490035R3
160	40	2	K449004000	K449004045	K4490040R1	K4490040R3
160	50	2	K449005000	K449005045	K4490050R1	K4490050R3

Ricambi / Spare parts / Rechanges / Repuestos / Ersatzteile

COD.	COD.	COD.	COD.	COD.	
0480030014	0480050030	0480050050	0480502600	0480504600	
COD.	COD.	COD.	COD.	COD.	
048060C000	0480700612	0480700620	048074A510	048074B515	
COD.	COD.	COD.	COD.	COD.	
048074C515	K48017E000	K48018R300	K48062E000	0480783000	048078T200
COD.	COD.	COD.	COD.	COD.	COD.
K480110000	K480120000	K480130000	K480140000	K480150000	K480160000

Door rebating cutter head set.

Juego de cabezales para perfil exterior de puertas.

Jeu de porte - outils pour calibrage de portes.

Messerkopfsatz für Türenaussenprofil.

# K 423 - 16 Gruppo di teste per il telaio delle porte

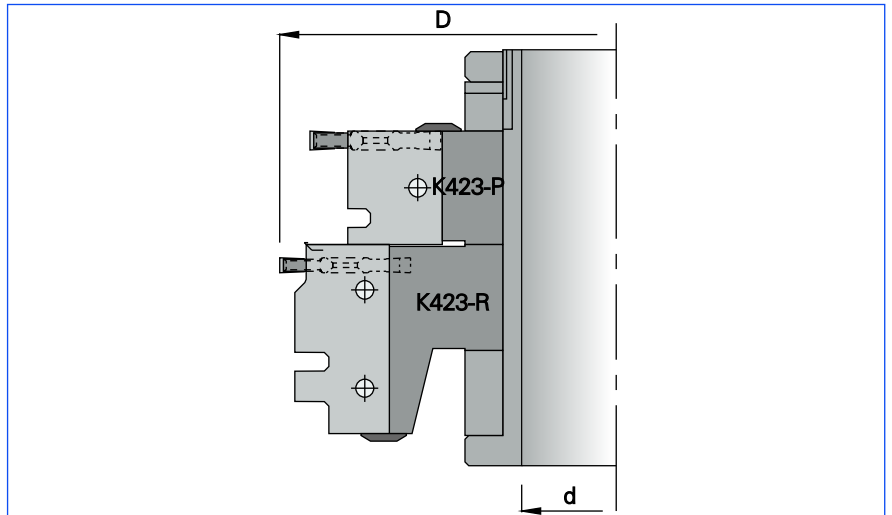







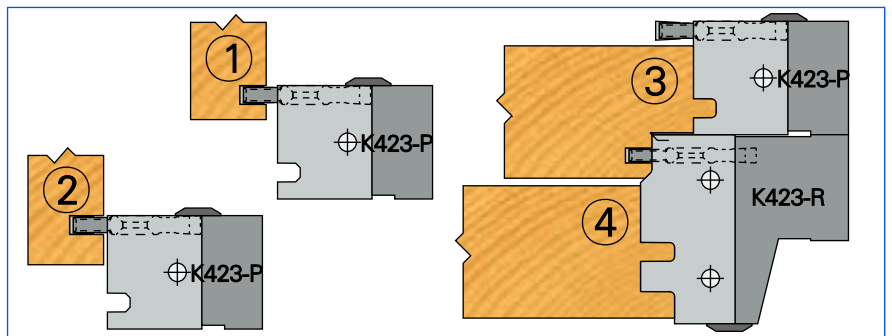
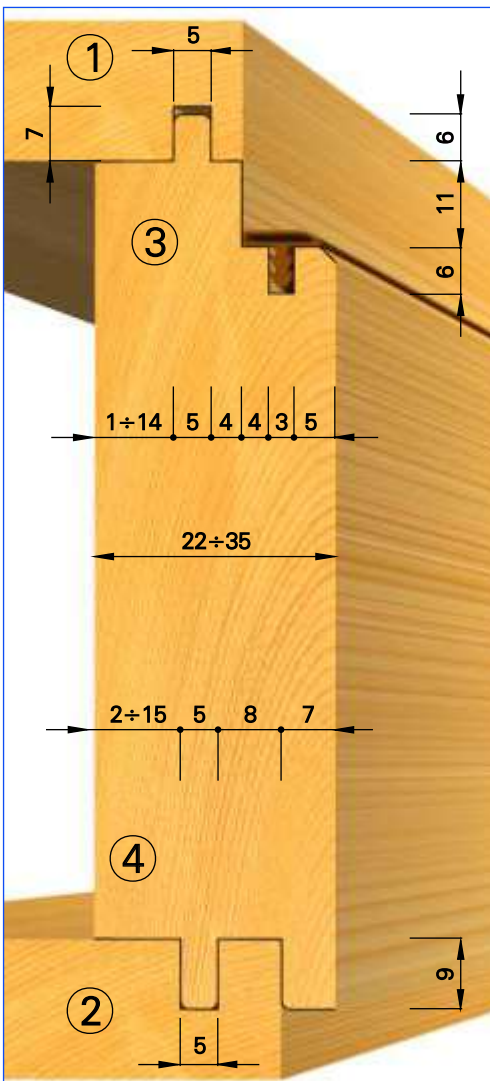

**HW** **MAN**

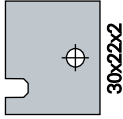
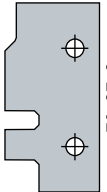
n 4300 - 7400

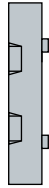
D	d	Z	V	COD.
176	30	2	2	K423163000
176	31.75	2	2	K423163100
176	35	2	2	K423163500
176	40	2	2	K423164000
176	50	2	2	K423165000

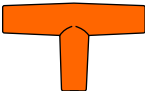
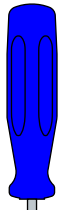

**Ricambi / Spare parts / Rechanges / Repuestos / Ersatzteile**

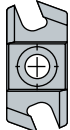
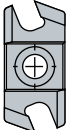
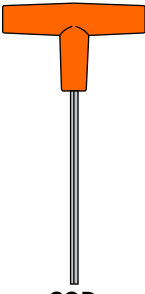
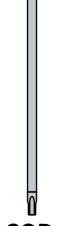
				
COD.	COD.	COD.	COD.	COD.
0480030014	K48023P000	K48023R000	0480522825	0480524825
				
COD.	COD.	COD.		
0480700820	048074A510	048074C515		
				
COD.	COD.	COD.	COD.	COD.
048073B000	K48017A000	K48017F000	048078L400	048078T200

 Cutter head set for door - frame profiling.

 Juego de cabezales para el marco de puertas.

 Jeu de porte - outils pour le chassis des portes.

 Türdichtung - Messerkopfsatz.



**HW**





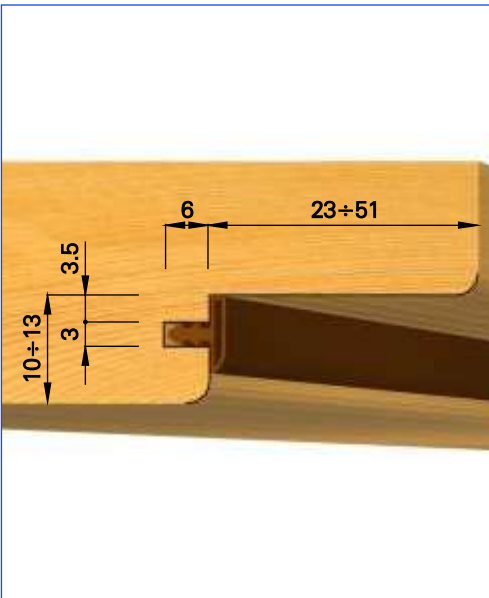
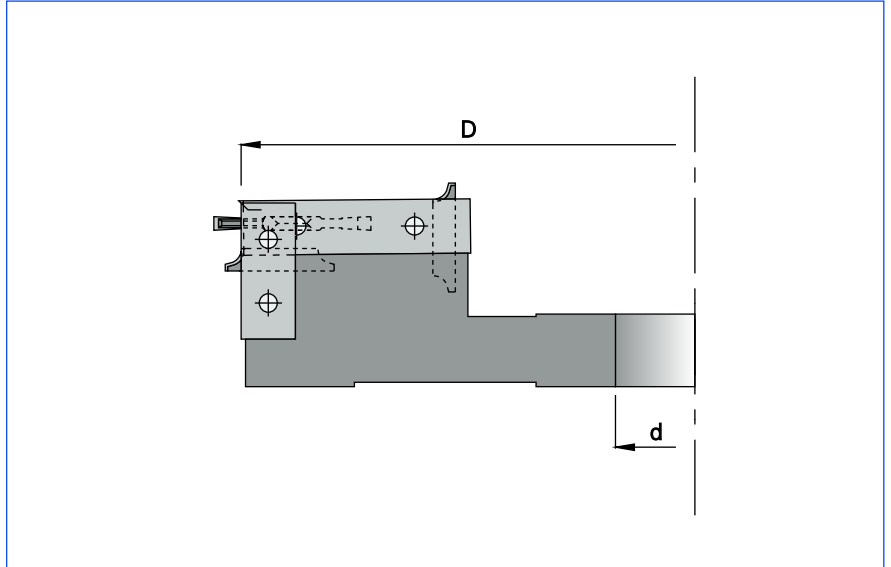

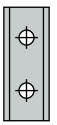
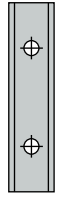
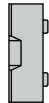
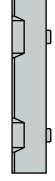

**MAN**

n 3900 - 6000

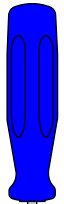
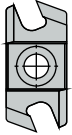

D	d	Z	COD.
200	30	2+2	K423D00030
200	31.75	2+2	K423D00031
200	35	2+2	K423D00035
200	40	2+2	K423D00040
200	50	2+2	K423D00050

### Ricambi / Spare parts / Rechanges / Repuestos / Ersatzteile

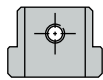
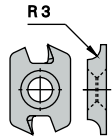
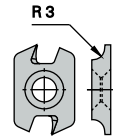
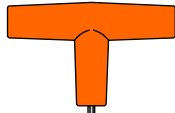
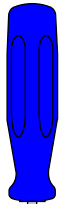
								
COD.	COD.	COD.	COD.	COD.	COD.	COD.	COD.	COD.
0480030014	0480050030	0480050050	0480502600	0480504600	048060C000	0480700612	0480705620	
								
COD.	COD.	COD.	COD.	COD.	COD.	COD.	COD.	COD.
K48017A000	048074A510	048074B515	048074C515	K48062E000	K480150000	K480160000	0480783000	048078T200

 Cutter head for door - frame.

 Cabezal para el marco de puertas.

 Porte - outil pour le chassis des portes.

 Tüрдichtung - Messerkopf.

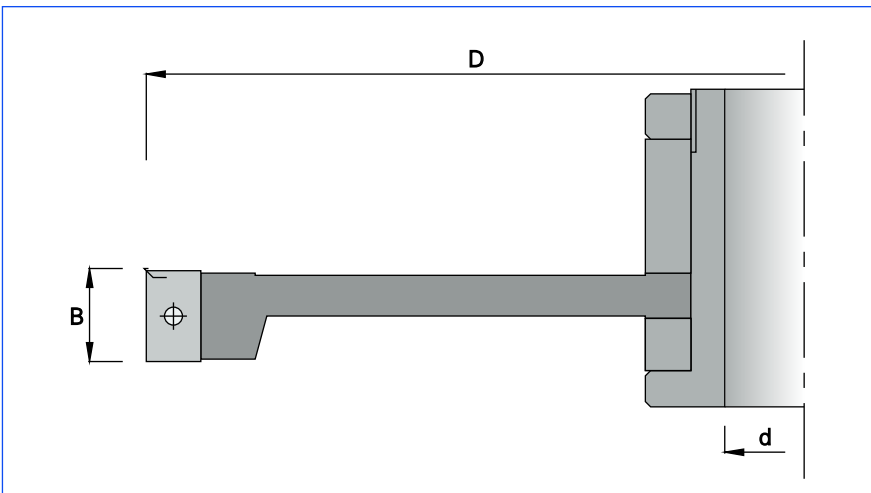

**HW**

**MAN**

n 2700 - 4600

D	B	d	Z	COD.
290	20	30	4	K423Z00030
290	20	31.75	4	K423Z00031
290	20	35	4	K423Z00035
290	20	40	4	K423Z00040
290	20	50	4	K423Z00050

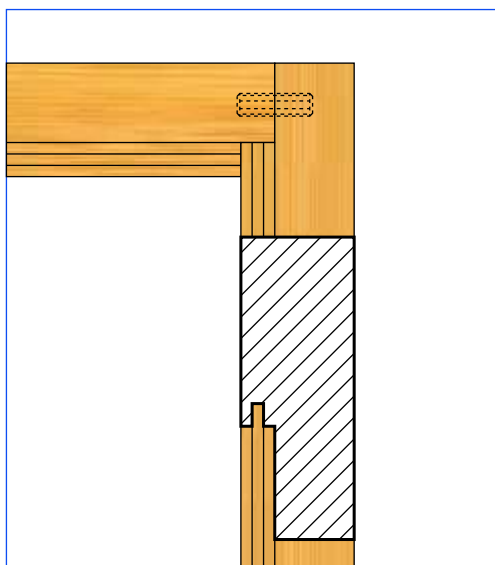
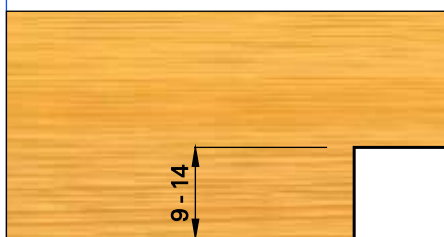
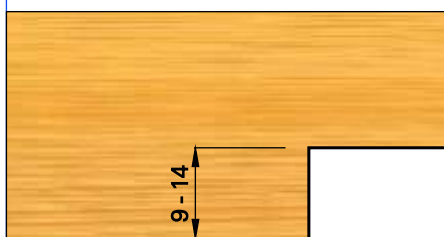

### Ricambi / Spare parts / Rechanges / Repuestos / Ersatzteile



COD.

0480030014



COD.

0480050020



COD.

0480501800



COD.

048060C000



COD.

0480700612



COD.

048074A510

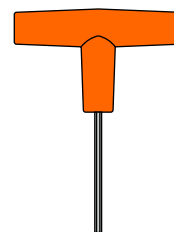

COD.

0480783000

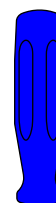



COD.

048078T200

 Cutter head for door - frame jointing.

 Cabezal para ensamble del marco.

 Porte - outils pour bouvetage de chassis.

 Messerkopf für Rahmenverbindung.

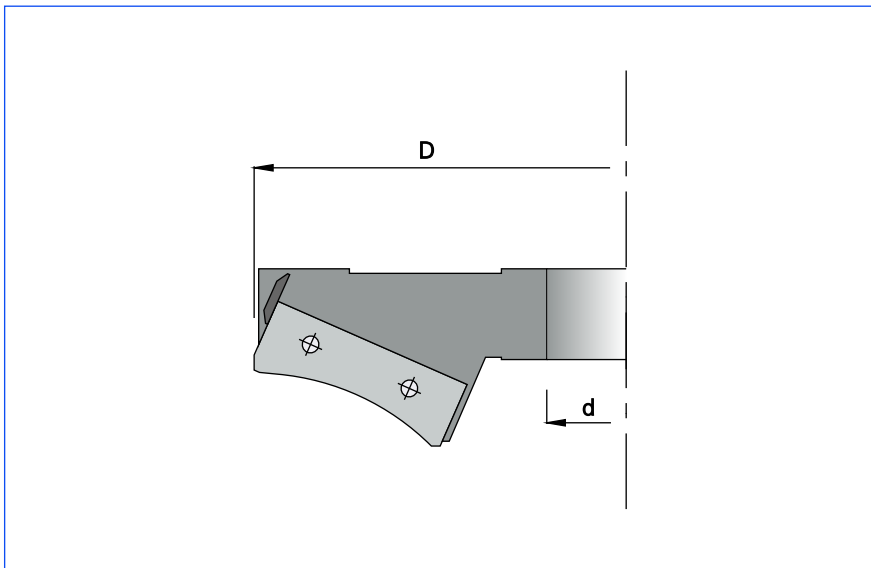

**HW**

**MAN**

D 164 n 4700 - 8100  
D 174 n 4400 - 7600

D	d	Z	COD.
164	30	3	K423183000
164	31.75	3	K423183100
164	35	3	K423183500
164	40	3	K423184000
174	50	3	K423185000

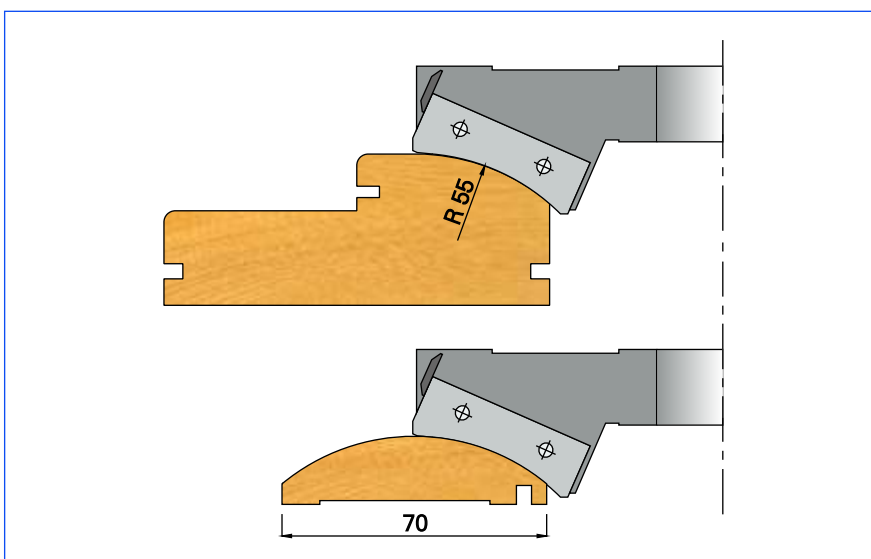

**Ricambi / Spare parts / Rechanges / Repuestos / Ersatzteile**

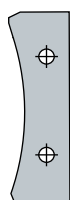

52.5x16x1.5

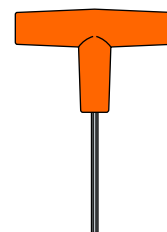
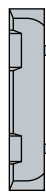

COD.  
K480231800

COD.  
048050AUVZ

COD.  
048060C000

COD.  
0480700612

COD.  
048073B000

COD.  
0480783000



Cutter head for door - frame.



Cabezal para el marco de puertas.



Porte - outil pour le chassis des portes.



Türdichtung - Messerkopf.

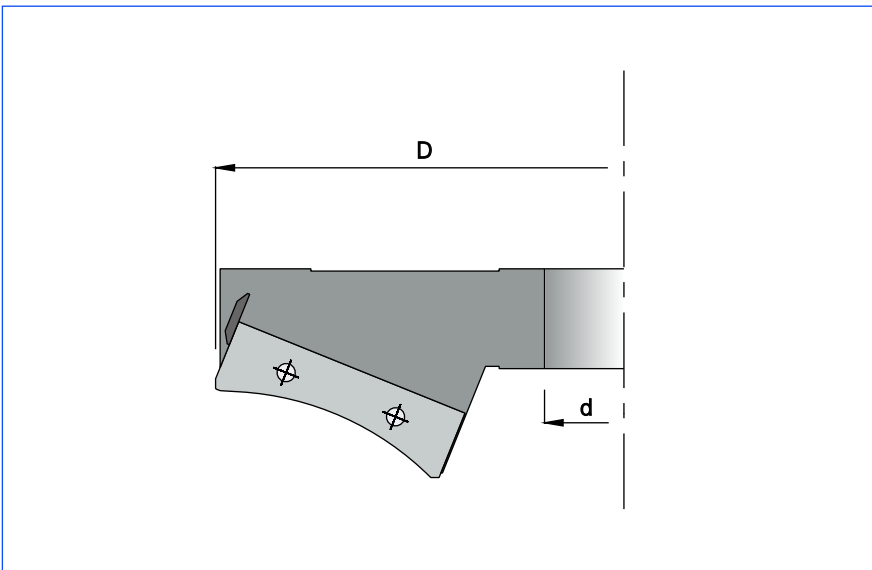

**HW**

**MAN**

n 4100 - 7000

D	d	Z	COD.
190	30	3	K423193000
190	31.75	3	K423193100
190	35	3	K423193500
190	40	3	K423194000
190	50	3	K423195000

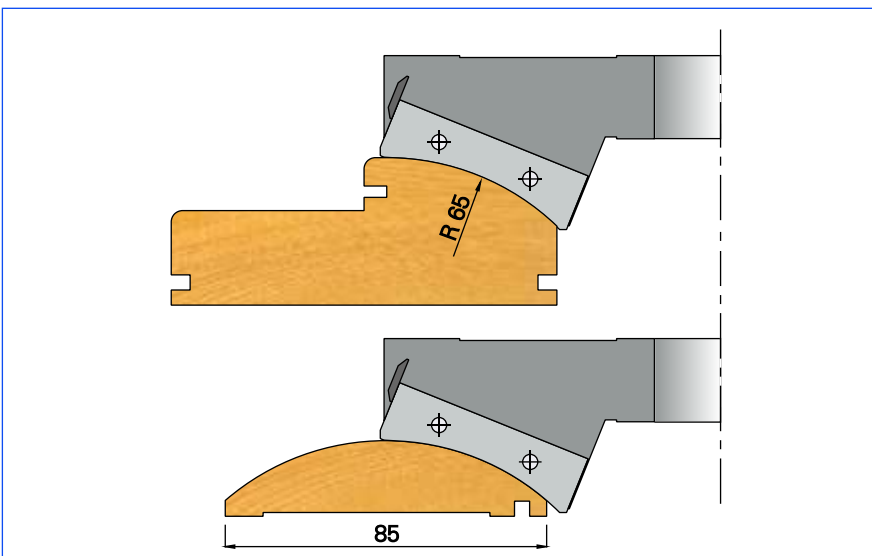

**Ricambi / Spare parts / Rechanges / Repuestos / Ersatzteile**

60x16x1.5					
COD.	COD.	COD.	COD.	COD.	COD.
K480231900	048050AUVZ	048060C000	0480700612	048073B000	0480783000

Cutter head for door - frame.

Cabezal para el marco de puertas.

Porte - outil pour le chassis des portes.

Türdichtung - Messerkopf.

# K 461 - 10

## Gruppo di teste per profili a doppio battente



**HW**

**MAN**

n 4100 - 7000

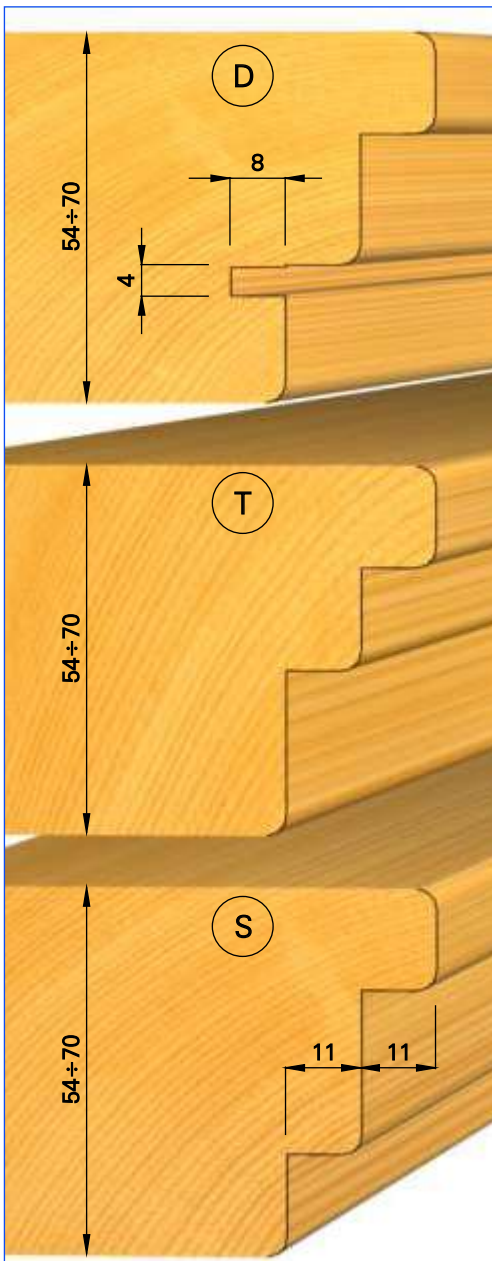
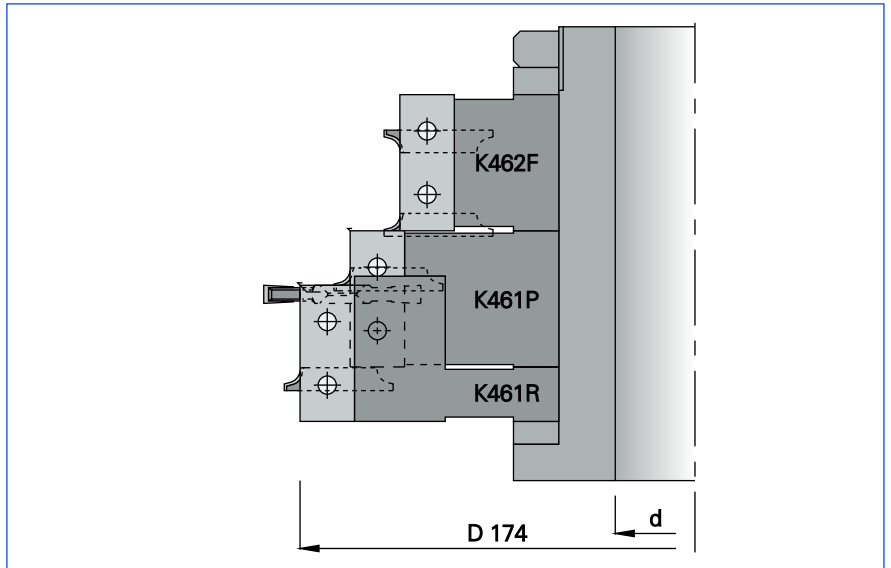

D	d	Z	COD.	COD.	COD.	COD.
174	30	2	K461103000	K461103045	K4611030R1	K4611030R3
174	31.75	2	K461103100	K461103145	K4611031R1	K4611031R3
174	35	2	K461103500	K461103545	K4611035R1	K4611035R3
174	40	2	K461104000	K461104045	K4611040R1	K4611040R3
174	50	2	K461105000	K461105045	K4611050R1	K4611050R3

### Ricambi / Spare parts / Rechanges / Repuestos / Ersatzteile

COD.	COD.	COD.	COD.	COD.	COD.
0480030014	0480050030	0480502600	048060C000	0480700612	0480700620
COD.	COD.	COD.	COD.	COD.	
048074A510	048074B515	048074C515	K48017E000	K48062E000	
COD.	COD.	COD.			
K480110000	K480130000	K480150000			
COD.	COD.	COD.			
K480120000	K480140000	K480160000			
			COD.	COD.	
			0480783000	048078T200	

Cutter head set for double - rebate profiles.

Juego de cabezales para perfiles con doble galces.

Jeu de porte - outils pour profils à double feuillure.

Messerkopfsatz für Doppelfalz - Profil.

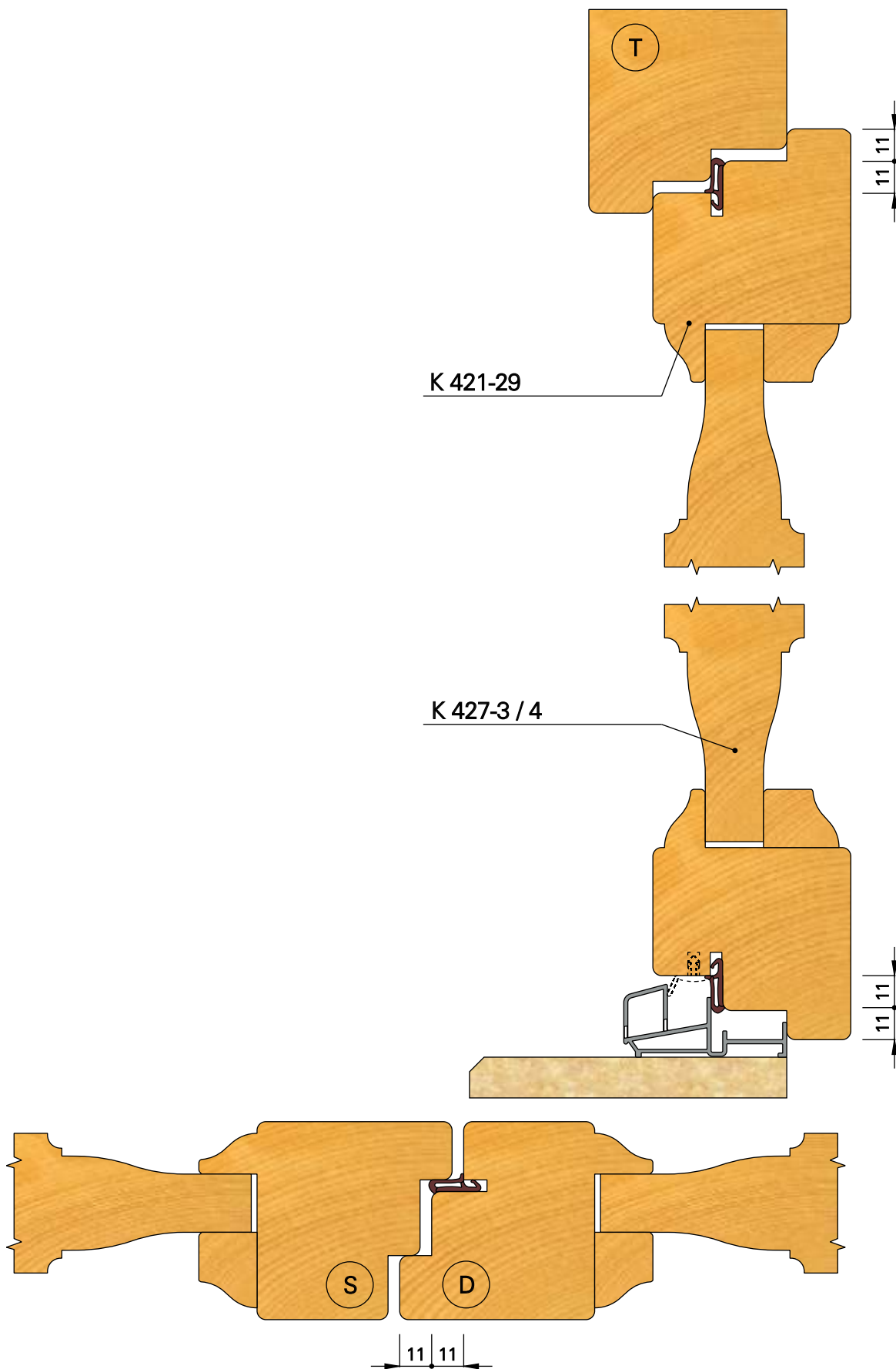

 Example of external door.

 Ejemplo de puerta exterior.

 Exemple de porte extérieure.

 Beispiel von Aussentür.



# K 448 - 10 Gruppo di teste per tenonatura telaio



HW

MAN

n 2700 - 4600

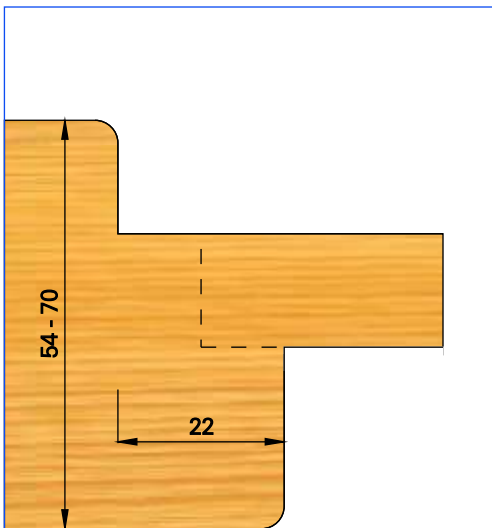
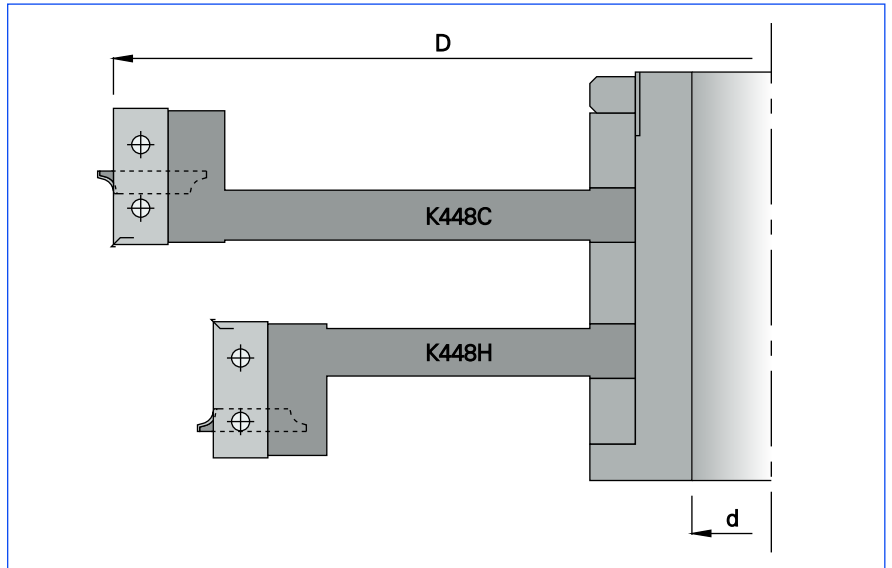

D	d	Z	COD.	COD.	COD.	COD.
290	30	4	K448103000	K448103045	K4481030R1	K4481030R3
290	31.75	4	K448103100	K448103145	K4481031R1	K4481031R3
290	35	4	K448103500	K448103545	K4481035R1	K4481035R3
290	40	4	K448104000	K448104045	K4481040R1	K4481040R3
290	50	4	K448105000	K448105045	K4481050R1	K4481050R3

**Ricambi / Spare parts / Rechanges / Repuestos / Ersatzteile**

COD.	COD.	COD.	COD.	COD.	COD.
0480030014	0480050030	0480502600	048060C000	0480700612	0480700620
COD.	COD.	COD.	COD.	COD.	COD.
048074A510	048074B515	K480110000	K480130000	K480150000	
COD.	COD.	COD.	COD.	COD.	COD.
K480120000	K480140000	K480160000	K48062E000	0480783000	048078T200

Set of tenoning cutter heads.

Juego de cabezales para espigar.

Jeu de porte - outils à tenonner.

Zapfenkopfsatz.



**HW**

**MAN**

n 2900 - 4900

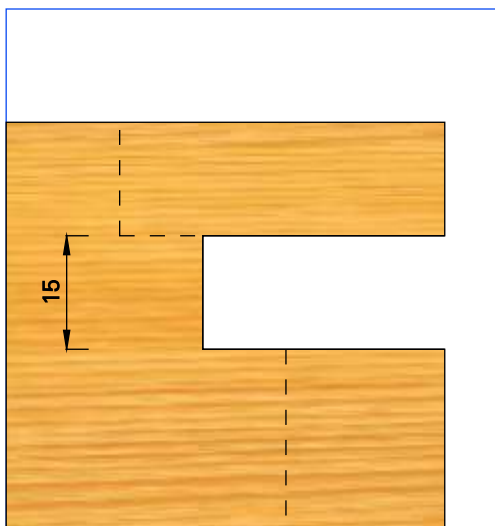
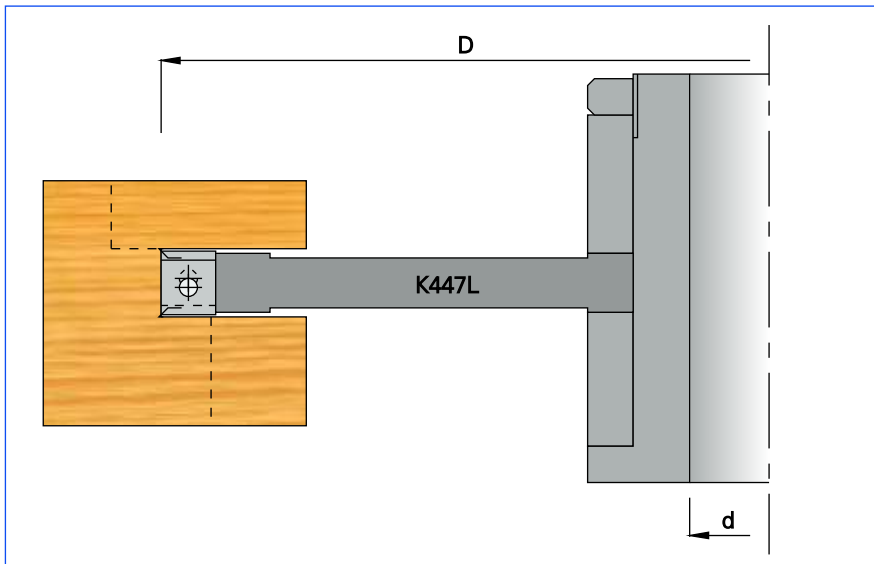

D	d	Z	V	COD.
268	30	4	4	K447103000
268	31.75	4	4	K447103100
268	35	4	4	K447103500
268	40	4	4	K447104000
268	50	4	4	K447105000

### Ricambi / Spare parts / Rechanges / Repuestos / Ersatzteile



COD.

0480030014



COD.

0480050012



COD.

0480501000



COD.

048060B000



COD.

0480700512



COD.

048074A510

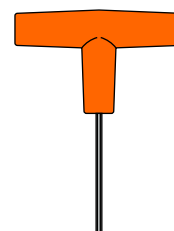

COD.

0480782500

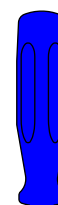

COD.

048078T200

Sleeved slotting cutter head for frame.

Cabezal para almillar el marco.

Porte - outils à enfourchement pour le chassis.

Schlitz - Scheibenkopf Türdichtung.

# K 461 - 20

## Gruppo di teste per profili a doppio battente



**HW**

**MAN**

n 3700 - 6300

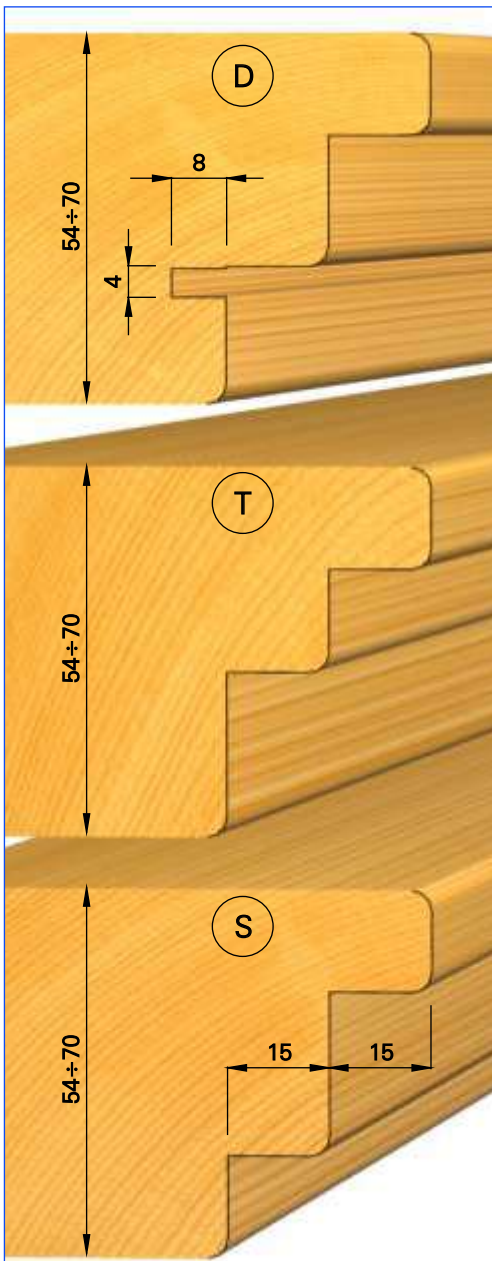
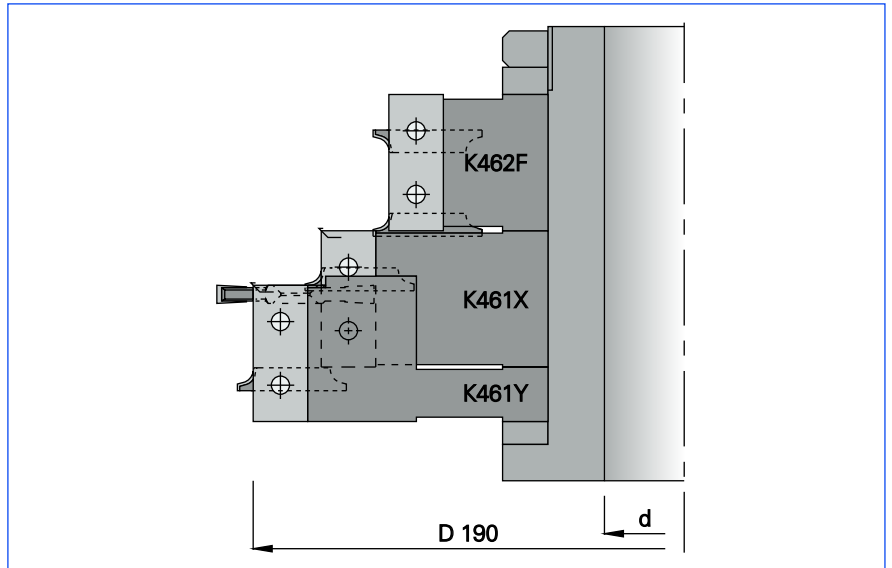

D	d	Z	COD.	COD.	COD.	COD.
190	30	2	K461203000	K461203045	K4612030R1	K4612030R3
190	31.75	2	K461203100	K461203145	K4612031R1	K4612031R3
190	35	2	K461203500	K461203545	K4612035R1	K4612035R3
190	40	2	K461204000	K461204045	K4612040R1	K4612040R3
190	50	2	K461205000	K461205045	K4612050R1	K4612050R3

**Ricambi / Spare parts / Rechanges / Repuestos / Ersatzteile**

COD.	COD.	COD.	COD.	COD.	COD.
0480030014	0480050030	0480502600	048060C000	0480700612	0480700620
COD.	COD.	COD.	COD.	COD.	
048074A510	048074B515	048074C515	K48017E000	K48062E000	
COD.	COD.	COD.			
K480110000	K480130000	K480150000			
COD.	COD.	COD.			
K480120000	K480140000	K480160000			

COD. COD.

0480783000 048078T200

Cutter head set for double - rebate profiles.

Juego de cabezales para perfiles con doble galces.

Jeu de porte - outils pour profils à double feuillure.

Messerkopfsatz für Doppelfalz - Profil.

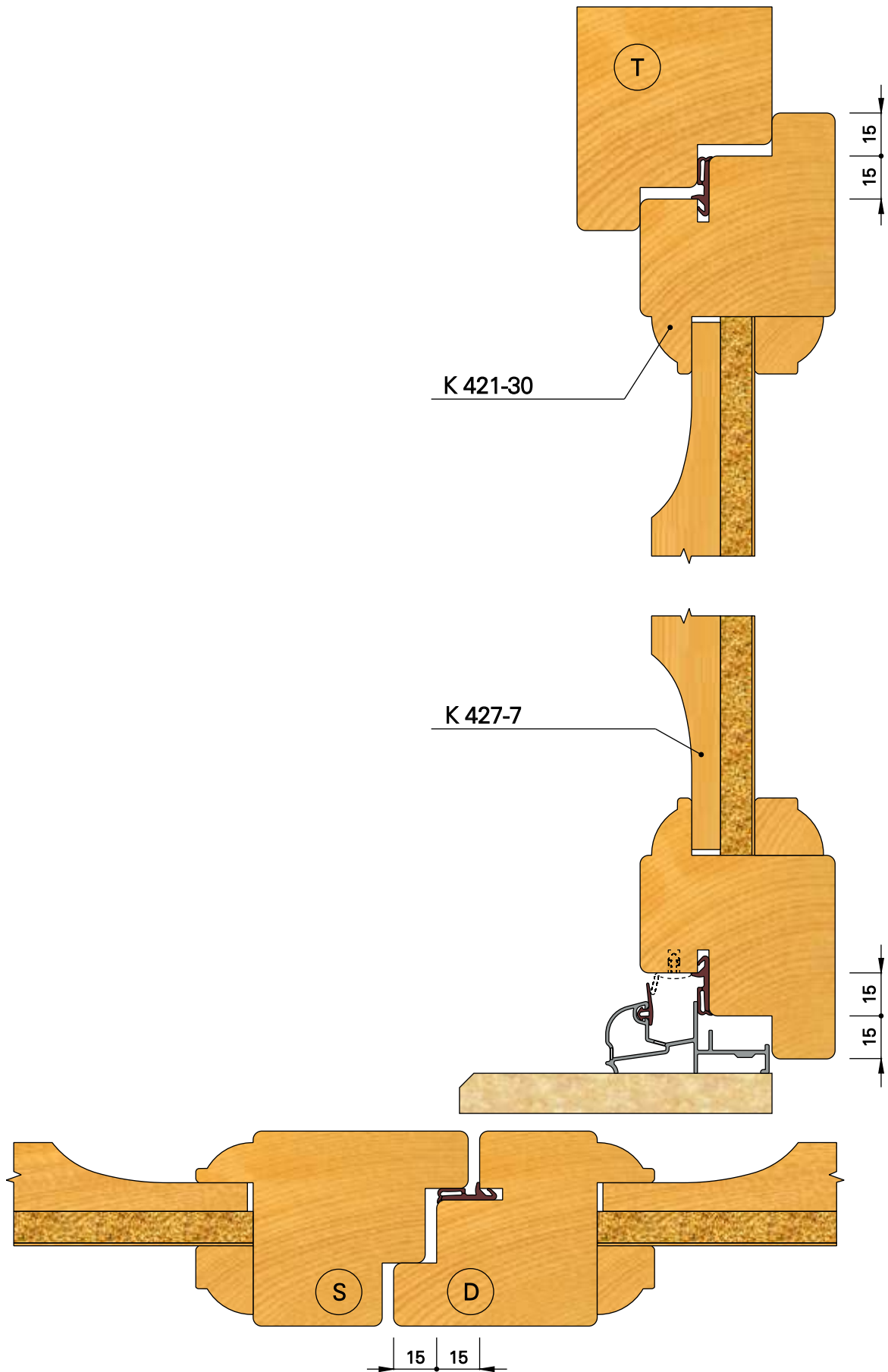

 Example of external door.

 Ejemplo de puerta exterior.

 Exemple de porte extérieure.

 Beispiel von Aussentür.



**HW**

**MAN**

n 2700 - 4600

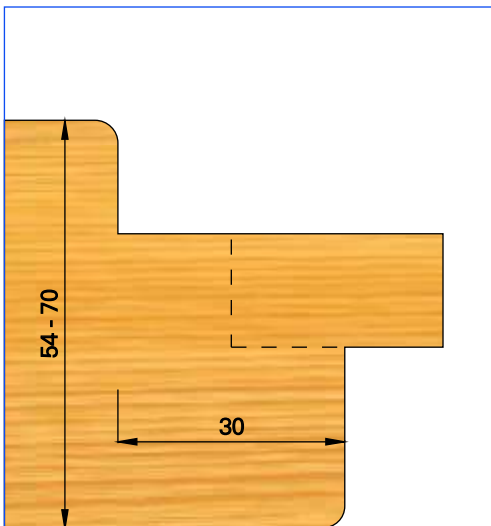
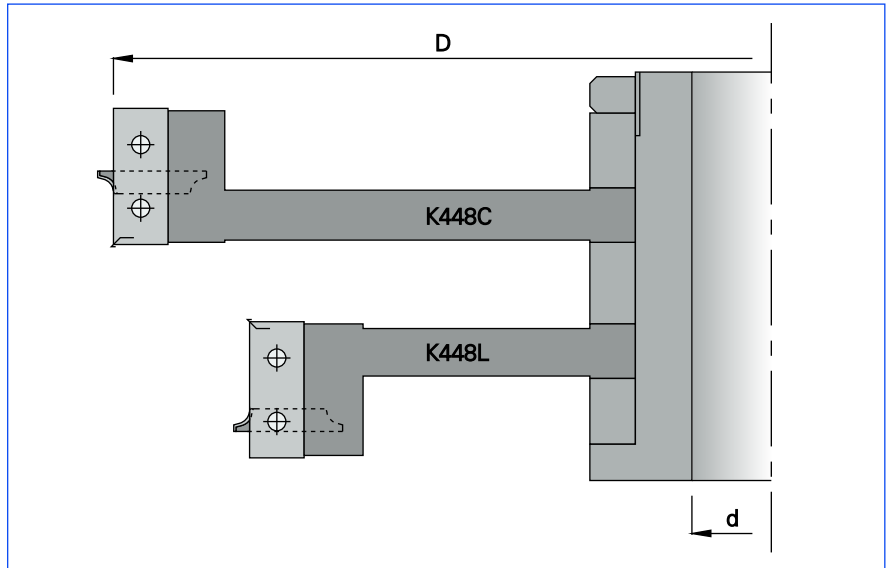

D	d	Z	COD.	COD.	COD.	COD.
290	30	4	K448053000	K448053045	K4480530R1	K4480530R3
290	31.75	4	K448053100	K448053145	K4480531R1	K4480531R3
290	35	4	K448053500	K448053545	K4480535R1	K4480535R3
290	40	4	K448054000	K448054045	K4480540R1	K4480540R3
290	50	4	K448055000	K448055045	K4480550R1	K4480550R3

**Ricambi / Spare parts / Rechanges / Repuestos / Ersatzteile**

COD.	COD.	COD.	COD.	COD.	COD.
0480030014	0480050030	0480502600	048060C000	0480700612	0480700620
COD.	COD.	COD.	COD.	COD.	
048074A510	048074B515	K480110000	K480130000	K480150000	
COD.	COD.	COD.	COD.	COD.	COD.
K480120000	K480140000	K480160000	K48062E000	0480783000	048078T200

Set of tenoning cutter heads.

Juego de cabezales para espigar.

Jeu de porte - outils à tenonner.

Zapfenkopfsatz.



**HW**

**MAN**

n 2900 - 5100

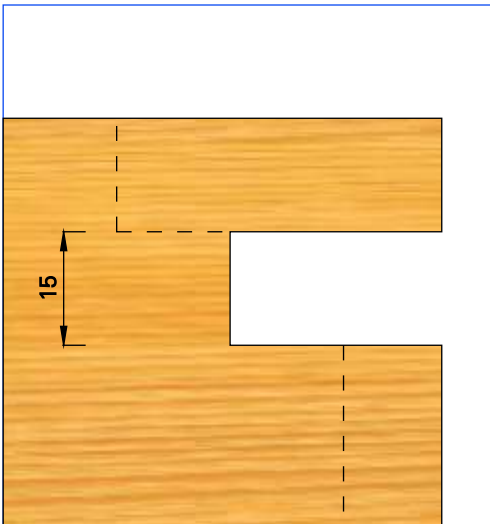
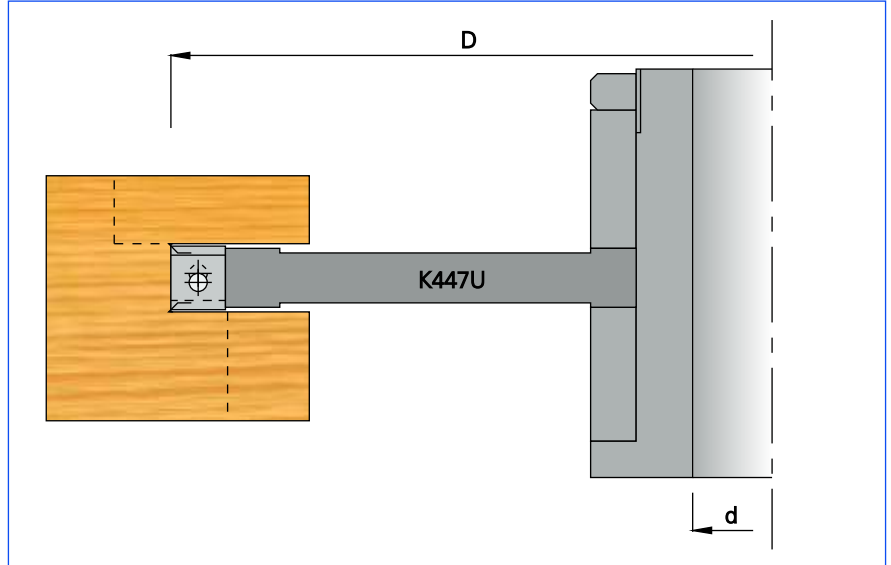

D	d	Z	V	COD.
260	30	4	4	K447173000
260	31.75	4	4	K447173100
260	35	4	4	K447173500
260	40	4	4	K447174000
260	50	4	4	K447175000

### Ricambi / Spare parts / Rechanges / Repuestos / Ersatzteile

COD.	COD.	COD.	
0480030014	0480050012	0480501000	
COD.	COD.	COD.	COD.
048060B000	0480700512	048074A510	0480782500
			048078T200

Sleeved slotting cutter head for frame.

Cabezal para almillar el marco.

Porte - outils à enfourchement pour le chassis.

Schlitz - Scheibenkopf Türdichtung.

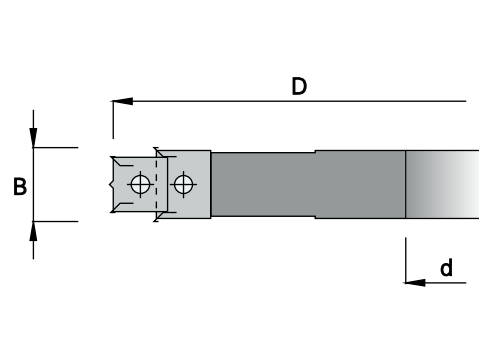

**HW**

**MAN**

n 4700 - 8100

D	B	d	Z	V	COD.
164	16.3	30	2+2	8	K443B16430
164	16.3	35	2+2	8	K443B16435
164	16.3	40	2+2	8	K443B16440
164	16.3	50	2+2	8	K443B16450

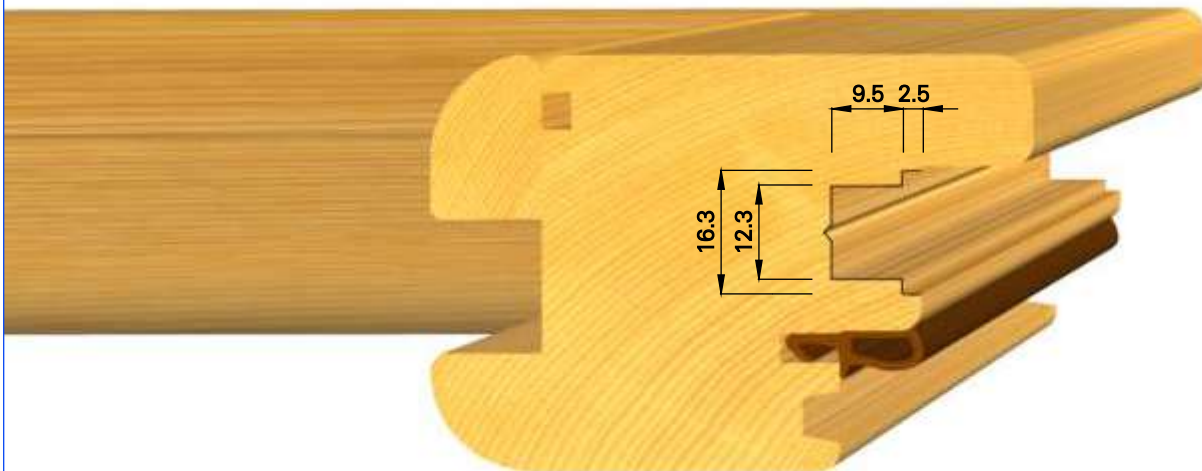

### Ricambi / Spare parts / Rechanges / Repuestos / Ersatzteile



COD.  
0480030014



COD.  
K480430000



COD.  
0480050015



COD.  
0480501000



COD.  
0480501300



COD.  
048060B000



COD.  
048060C000



COD.  
0480700512



COD.  
0480700612



COD.  
048074A510

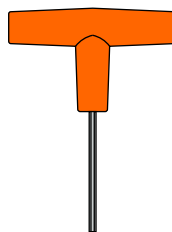

COD.  
0480782500

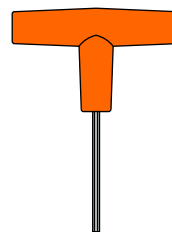

COD.  
0480783000



Cutter head for fitting groove.



Cabezal para falleba.



Porte - outil pour cremone.



Messerkopf für Beschlagnut.

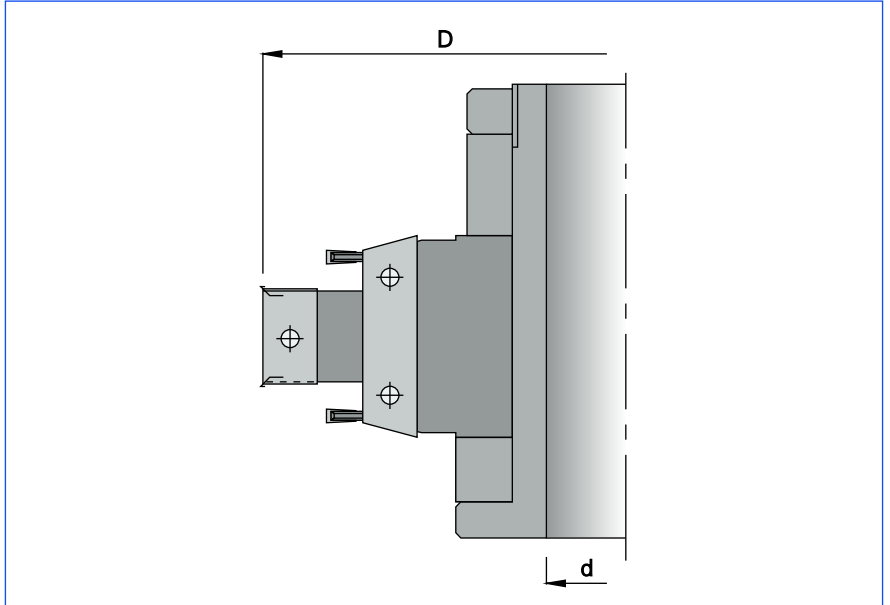

**HW** **MAN**

n 4800 - 8300

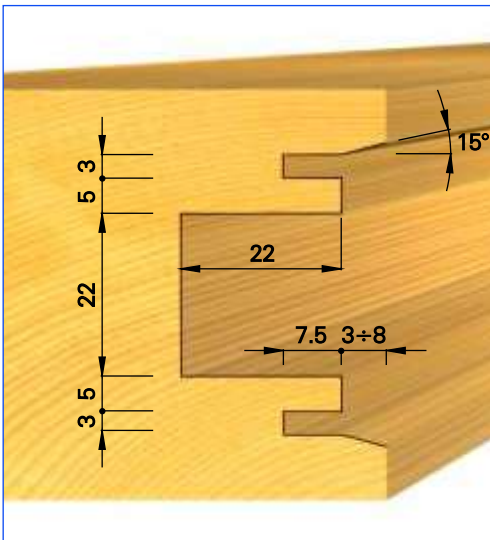

D	d	Z	COD.
160	30	2+2	K439B16030
160	31.75	2+2	K439B16031
160	35	2+2	K439B16035
160	40	2+2	K439B16040
160	50*	2+2	K439B16050

\* Senza mozzo / Without sleeve / Sans manchon / Sin casquillo / Ohne Spannbuchse.

### Ricambi / Spare parts / Rechanges / Repuestos / Ersatzteile

COD. 0480030014	COD. 0480050020	COD. K48039B000	COD. 0480501800	COD. 0480503600	COD. K48017A000		COD. 0480783000	COD. 048078T200
COD. 048060C000	COD. 0480700612	COD. 048074A510	COD. 048074C515					

Cutter head for sliding doors.	Cabezal para ventana corredera.
Porte - outil pour chassis coulissants.	Messerkopf für Schiebentüren.



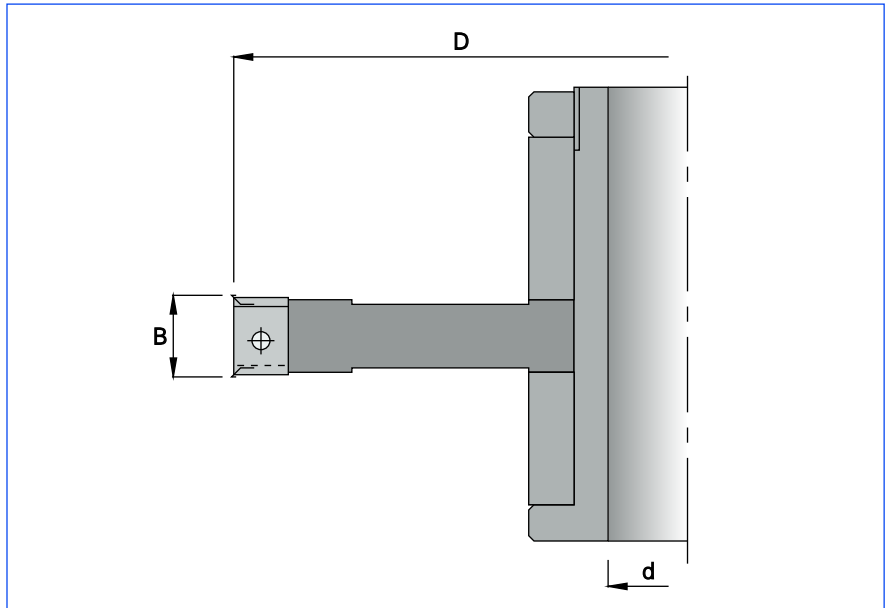

**HW**

**MAN**

n 3900 - 6600

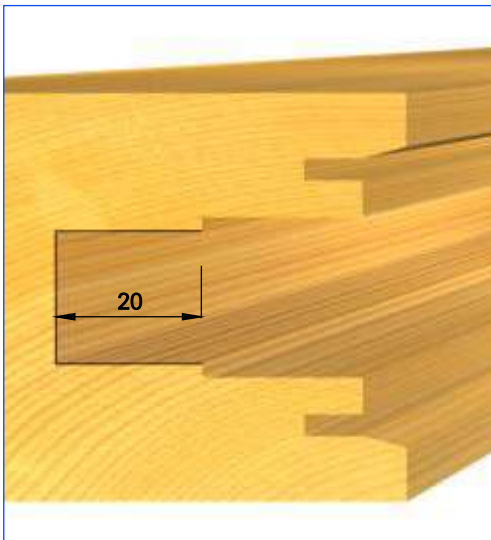

D	B	d	Z	V	COD.
200	18	30	2	4	K439C20030
200	18	31.75	2	4	K439C20031
200	18	35	2	4	K439C20035
200	18	40	2	4	K439C20040
200	18	50*	2	4	K439C20050

\* Senza mozzo / Without sleeve / Sans manchon / Sin casquillo / Ohne Spannbuchse.

Ricambi / Spare parts / Rechanges / Repuestos / Ersatzteile

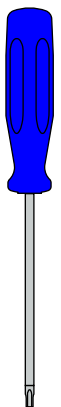
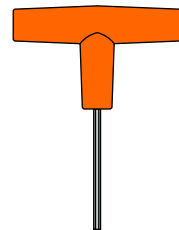

COD.  
0480030014

COD.  
0480050015

COD.  
0480501300

COD.  
048060C000

COD.  
0480700612

COD.  
048074A510

COD.  
0480783000

COD.  
048078T200

Cutter head for sliding doors.

Cabezal para ventana corredera.

Porte - outil pour chassis coulissants.

Messerkopf für Schiebetüren.

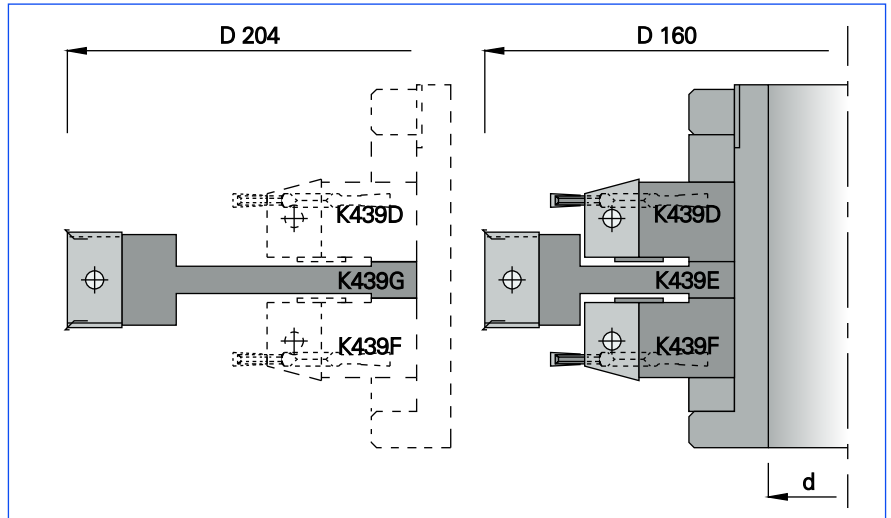

**HW**

**MAN**

D 160 n 4800 - 8300  
D 204 n 3800 - 6500

**SET COMPLETO ( K 439 D + K 439 E + K 439 F + K 439 G )**

D	d	Z	COD.
160 / 204	30	2	K439013000
160 / 204	31.75	2	K439013100
160 / 204	35	2	K439013500
160 / 204	40	2	K439014000
160 / 204	50*	2	K439015000

\* Senza mozzo / Without sleeve / Sans manchon / Sin casquillo / Ohne Spannbuchse.

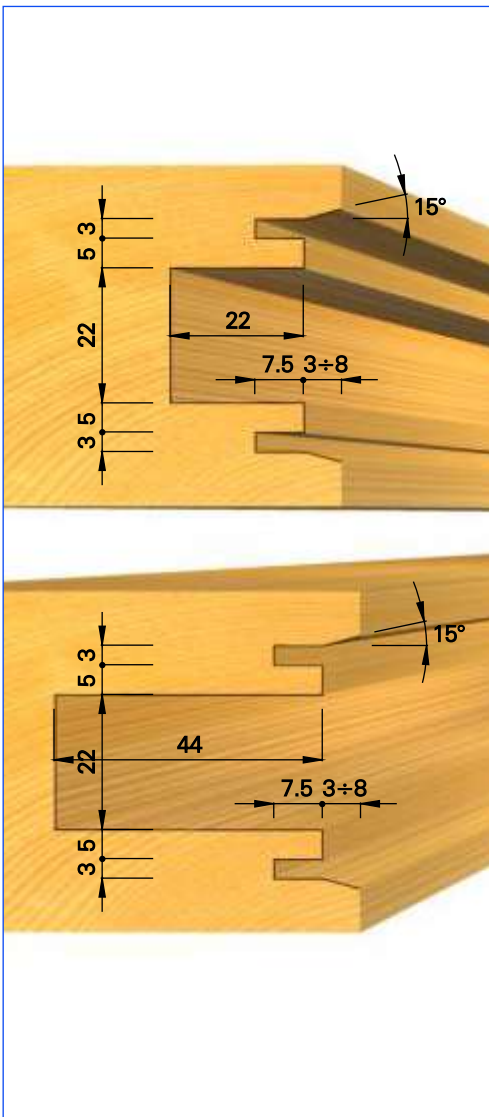

ART.	D	d	Z	COD.
K439 - D	116	50	2	K439D05000
K439 - E	160	50	2	K439E05000
K439 - F	116	50	2	K439F05000
K439 - G	204	50	2	K439G05000

**Ricambi / Spare parts / Rechanges / Repuestos / Ersatzteile**

COD.	COD.	COD.	COD.	COD.	COD.
0480030014	0480050020	K48039D000	K48039F000	0480501800	048053K439
COD.	COD.	COD.	COD.	COD.	
048060B000	048060C000	0480700512	0480700612	K48017A000	
COD.	COD.	COD.	COD.	COD.	COD.
048074A510	048074C515	048073A000	0480782500	0480783000	048078T200

Cutter head set for sliding doors.

Juego de cabezales para ventana corredera.

Jeu de porte - outils pour chassis coulissants.

Messerkopfsatz für Schiebetüren.

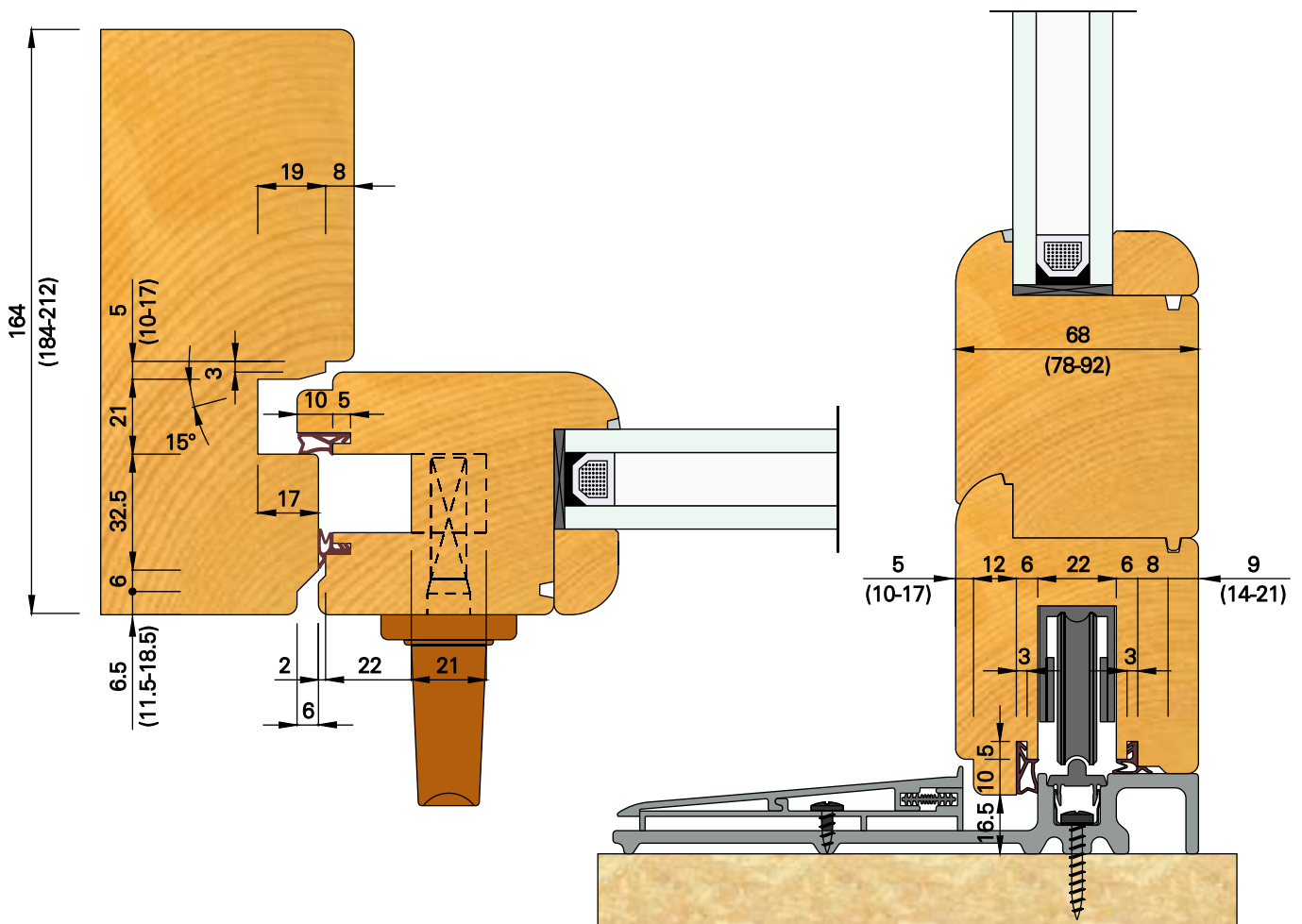

 Example of a sliding door.

 Ejemplo de ventana corredera.

 Exemple de chassis coulissants.

 Beispiel von Schiebetüren.

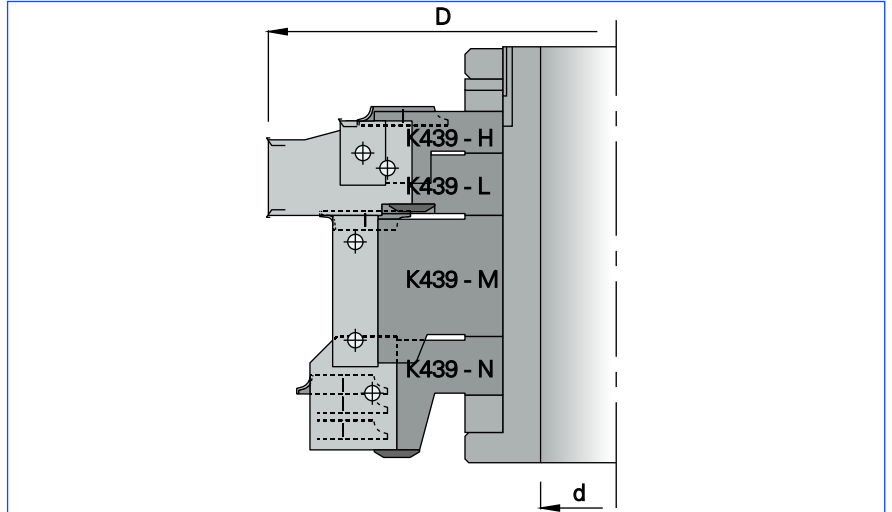







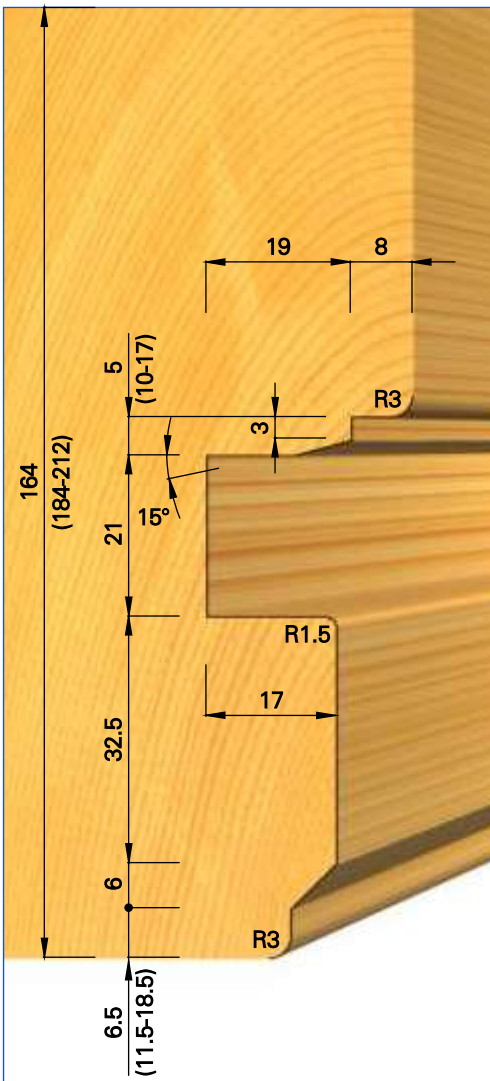



**HW**      **MAN**

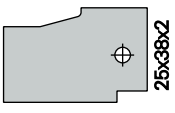
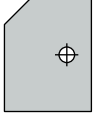

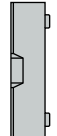
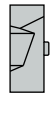
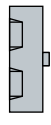

n 4200 - 7200

D	d	Z	V	COD.
184	30	2	2+2	K439023000
184	31.75	2	2+2	K439023100
184	35	2	2+2	K439023500
184	40	2	2+2	K439024000
184	50	2	2+2	K439025000

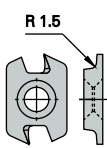
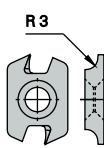
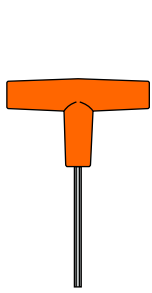
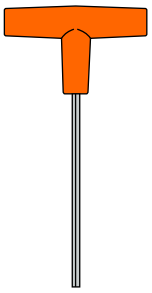
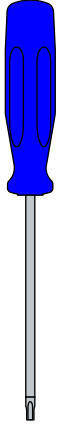

**Ricambi / Spare parts / Rechanges / Repuestos / Ersatzteile**

					
COD.	COD.	COD.	COD.	COD.	COD.
0480030014	0480050017	0480050040	K48039L000	K48039N000	0480501300
					
COD.	COD.	COD.	COD.	COD.	COD.
0480503600	048053232L	0480522825	048060C000	0480700612	0480700820
					
COD.	COD.				
048074A510	048074B515				
					
COD.	COD.	COD.	COD.	COD.	COD.
048073B000	K480130000	K480160000	0480783000	048078L400	048078T200

 Cutter head set for sliding doors.	 Juego de cabezales para ventana corredera.
 Jeu de porte - outils pour chassis coulissants.	 Messerkopfsatz für Schiebentüren.

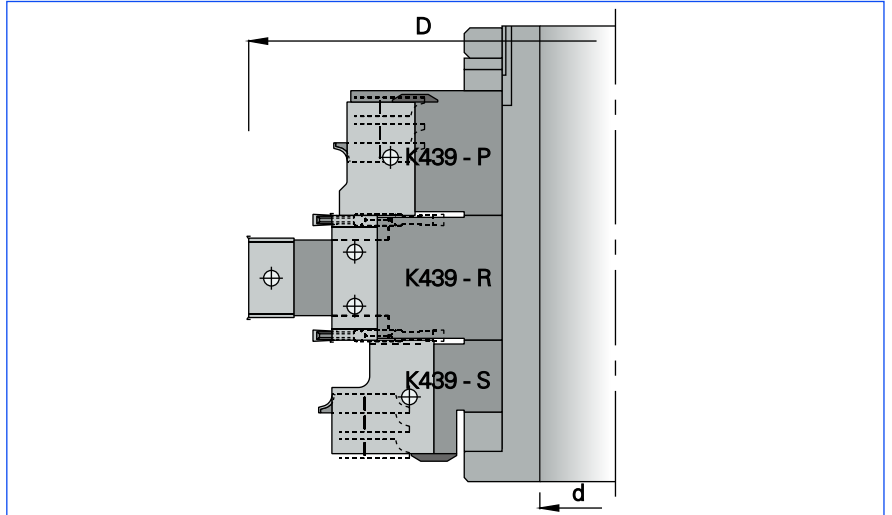

**HW**      **MAN**

n 4000 - 6800

D	d	Z	V	COD.
194	30	2	2+2	K439033000
194	31.75	2	2+2	K439033100
194	35	2	2+2	K439033500
194	40	2	2+2	K439034000
194	50	2	2+2	K439035000

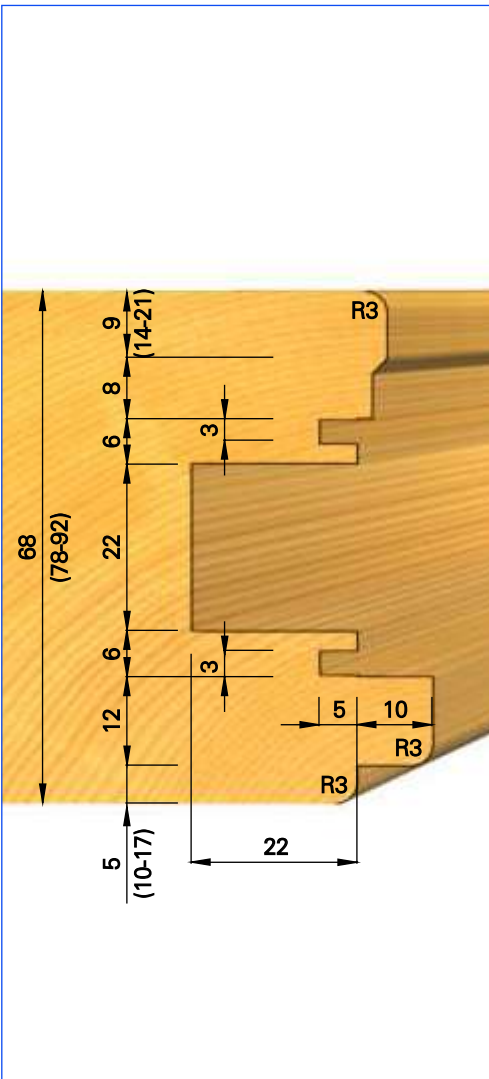

**Ricambi / Spare parts / Rechanges / Repuestos / Ersatzteile**

COD.	COD.	COD.	COD.	COD.	COD.
0480030014	0480050020	0480050030	K48039P000	K48039S000	0480501800
COD.	COD.	COD.	COD.	COD.	COD.
0480502600	0480522825	048053282L	048060C000	0480700612	0480700820
COD.	COD.	COD.	COD.	COD.	COD.
048074A510	048074B515	048074C515	048073B000	K480150000	K480160000
COD.	COD.	COD.	COD.	COD.	COD.
K48017A000	0480783000	048078L400	048078T200		

COD.	COD.	COD.	COD.
K48017A000	0480783000	048078L400	048078T200

Cutter head set for sliding doors.	Juego de cabezales para ventana corredera.
Jeu de porte - outils pour chassis coulissants.	Messerkopfsatz für Schiebetüren.

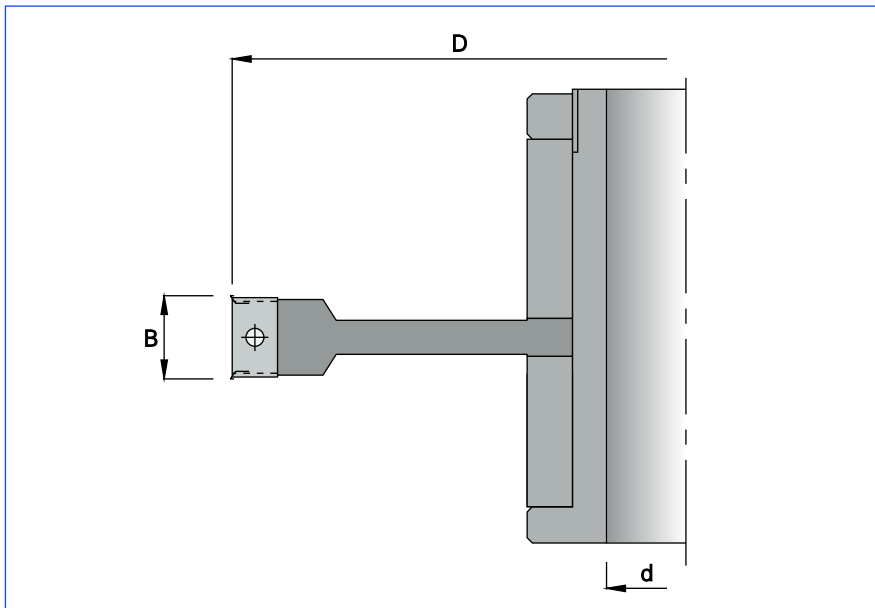

**HW**

**MAN**

n 3200 - 5500

D	B	d	Z	V	COD.
236	22	30	4	4	K439Z23630
236	22	31.75	4	4	K439Z23631
236	22	35	4	4	K439Z23635
236	22	40	4	4	K439Z23640
236	22	50	4	4	K439Z23650

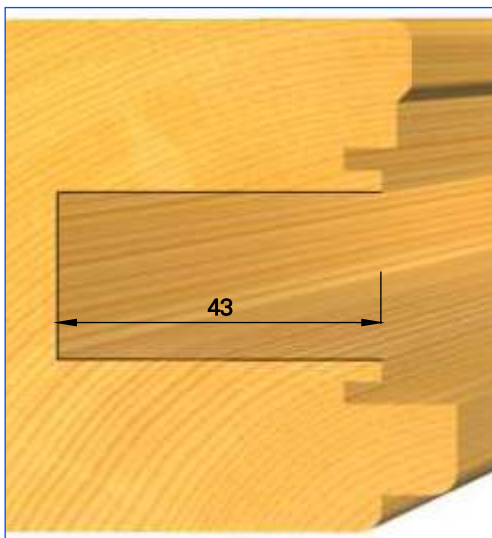

Ricambi / Spare parts / Rechanges / Repuestos / Ersatzteile

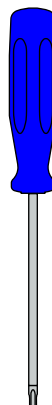
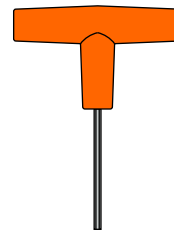

COD.  
0480030014

COD.  
0480050020

COD.  
0480501800

COD.  
048060C000

COD.  
0480700612

COD.  
048074A510

COD.  
0480783000

COD.  
048078T200

Cutter head for sliding doors.

Cabezal para ventana corredera.

Porte - outil pour chassis coulissants.

Messerkopf für Schiebentüren.

# Punte ed utensili per centri di lavoro



Bits and tools for CNC machining centres.











































Brocas y herramientas por CNC.



Mèches et outils pour CNC.



Bohrer und Werkzeuge für CNC.

	<p>ART. 508 / 509</p>  <p>6.2</p>	<p>ART. 510</p>  <p>6.4</p>	<p>ART. 511 / 512</p>  <p>6.4</p>	<p>ART. 513</p>  <p>6.5</p>
	<p>ART. 550 / 552</p>  <p>6.8</p>	<p>ART. 558</p>  <p>6.12</p>	<p>ART. 559</p>  <p>6.13</p>	<p>ART. 560 / 561</p>  <p>6.14</p>
	<p>ART. 562</p>  <p>6.15</p>	<p>ART. 564</p>  <p>6.16</p>	<p>ART. 566</p>  <p>6.17</p>	
	<p>ART. 556</p>  <p>6.11</p>	<p>ART. 568</p>  <p>6.18</p>	<p>ART. 570</p>  <p>6.19</p>	<p>ART. 572</p>  <p>6.20</p>
	<p>ART. 606 / 614</p>  <p>6.22</p>	<p>ART. 616 / 620</p>  <p>6.32</p>	<p>ART. 517</p>  <p>6.35</p>	<p>ART. 519 / 520</p>  <p>6.41</p>
	<p>ART. 615</p>  <p>6.26</p>	<p>ART. 615 - F</p>  <p>6.27</p>	<p>ART. 615 - A</p>  <p>6.28</p>	<p>ART. 615 - B</p>  <p>6.29</p>
	<p>ART. 650</p>  <p>6.44</p>			
	<p>ART. 526 - A / L</p>  <p>6.46</p>	<p>ART. 526 - K</p>  <p>6.54</p>	<p>ART. 527</p>  <p>6.58</p>	<p>ART. 528 - A / N</p>  <p>6.61</p>
	<p>ART. 520 - B</p>  <p>6.66</p>	<p>ART. 520 - C</p>  <p>6.67</p>	<p>ART. 520 - E</p>  <p>6.68</p>	





































 Bits and tools for CNC machining centres.

 Brocas y herramientas por CNC.

 Mèches et outils pour CNC.

 Bohrer und Werkzeuge für CNC.

	<p>ART. 520 - F</p>  <p>6.69</p>	<p>ART. 625 - A</p>  <p>6.73</p>	<p>ART. 625 - C</p>  <p>6.74</p>	<p>ART. 625 - E</p>  <p>6.75</p>
	<p>ART. 520 - L</p>  <p>6.71</p>			
	<p>ART. 626 - A</p>  <p>6.76</p>	<p>ART. 626 - C</p>  <p>6.77</p>		
	<p>ART. 626 - E</p>  <p>6.77</p>	<p>ART. K420 - PA20</p>  <p>6.79</p>		
	<p>ART. 626 - R</p>  <p>6.78</p>	<p>ART. 629 - A</p>  <p>6.85</p>		
	<p>ART. 626 - L / H</p>  <p>6.82</p>	<p>ART. 626 - M</p>  <p>6.83</p>	<p>ART. 631 - E</p>  <p>6.84</p>	<p>ART. 626 - G / H</p>  <p>6.87</p>
	<p>ART. 626 - S / T</p>  <p>6.89</p>	<p>ART. 627 - A / B</p>  <p>6.90</p>	<p>ART. 627 - A / C</p>  <p>6.91</p>	<p>ART. 627 - F / E</p>  <p>6.92</p>
	<p>ART. 624 - B1</p>  <p>6.94</p>	<p>ART. 623 - 06</p>  <p>6.95</p>	<p>ART. 623 - D</p>  <p>6.96</p>	<p>ART. 628 - Z</p>  <p>6.97</p>
	<p>ART. 628 - A</p>  <p>6.80</p>	<p>ART. 628 - B</p>  <p>6.81</p>	<p>ART. 631 - F</p>  <p>6.98</p>	<p>ART. 643 - B</p>  <p>6.99</p>





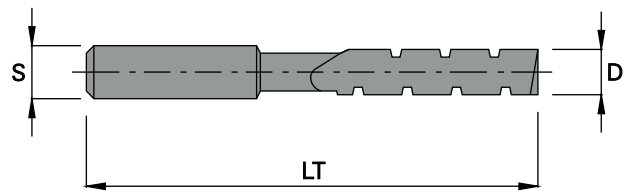

HL



D	LT	S	Z	COD. RH	COD. LH
6	105	13x50	2	05080613R0	05080613L0
6	105	16x50	2	05080616R0	05080616L0
7	110	13x50	2	05080713R0	05080713L0
7	110	16x50	2	05080716R0	05080716L0
8	115	13x50	2	05080813R0	05080813L0
8	115	16x50	2	05080816R0	05080816L0
9	120	13x50	2	05080913R0	05080913L0
9	120	16x50	2	05080916R0	05080916L0
10	125	13x50	2	05081013R0	05081013L0
10	125	16x50	2	05081016R0	05081016L0
11	130	13x50	2	05081113R0	05081113L0
11	130	16x50	2	05081116R0	05081116L0
12	135	13x50	2	05081213R0	05081213L0
12	135	16x50	2	05081216R0	05081216L0
13	140	13x50	2	05081313R0	05081313L0
13	140	16x50	2	05081316R0	05081316L0
14	145	13x50	2	05081413R0	05081413L0
14	145	16x50	2	05081416R0	05081416L0
15	150	13x50	2	05081513R0	05081513L0
15	150	16x50	2	05081516R0	05081516L0
16	155	13x50	2	05081613R0	05081613L0
16	155	16x50	2	05081616R0	05081616L0
17	160	13x50	2	05081713R0	05081713L0
17	160	16x50	2	05081716R0	05081716L0
18	165	13x50	2	05081813R0	05081813L0
18	165	16x50	2	05081816R0	05081816L0
19	170	13x50	2	05081913R0	05081913L0
19	170	16x50	2	05081916R0	05081916L0
20	175	13x50	2	05082013R0	05082013L0
20	175	16x50	2	05082016R0	05082016L0



Slot mortise bit with chip-breakers.



Broca para escoplear con ranuras para salida de viruta.



Mèche à mortaiser avec brise - copeaux.



Langlochbohrer mit Spanbrecher.

# 509

## Confezione di 6 punte per mortasare a taglienti diritti con rompitruciolo ( art. 508 )

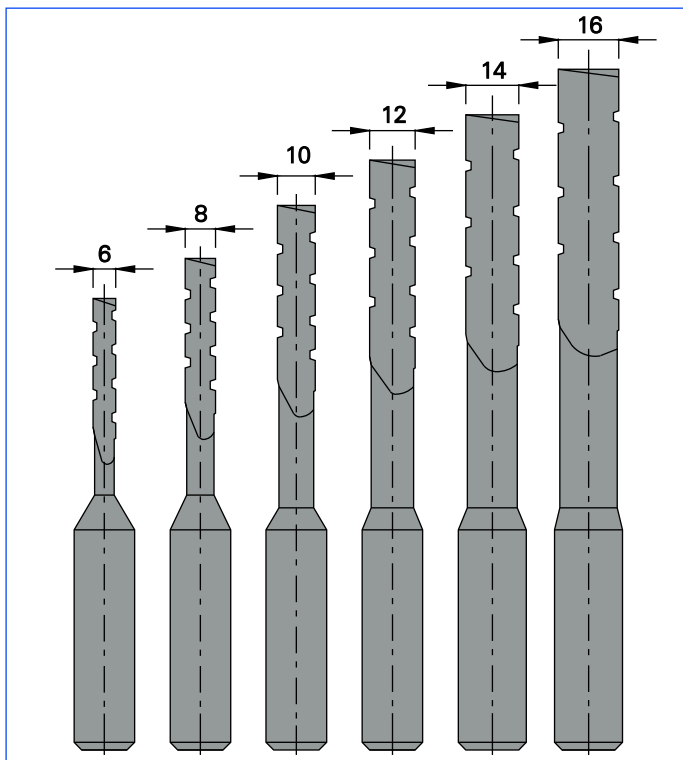

**HL**

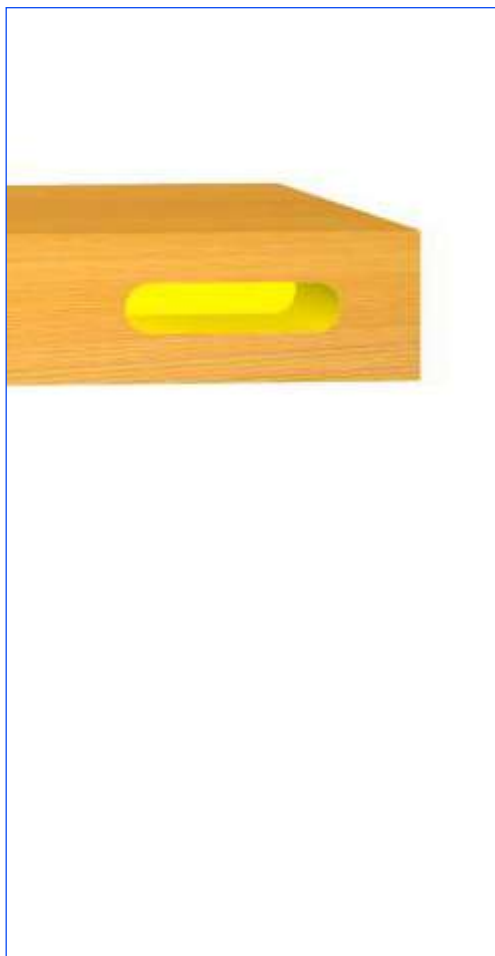

S	Z	COD. RH	COD. LH
13x50	2	05090013R0	05090013L0
16x50	2	05090016R0	05090016L0



Set of 6 mortise bits with chip-breakers. ( Art. 508 )



Grupo de 6 brocas para escoplear con ranuras para salida de viruta. (Art. 508 )



Jeu de 6 mèches à mortaiser avec brise - copeaux. ( Art. 508 )



Bohrersatz bestehend aus Nr. 6 Geradeschneiden Langlochbohrer mit Spanbrecher. ( Art. 508 )

# 510

## Punta per mortasare a taglienti ambidestri

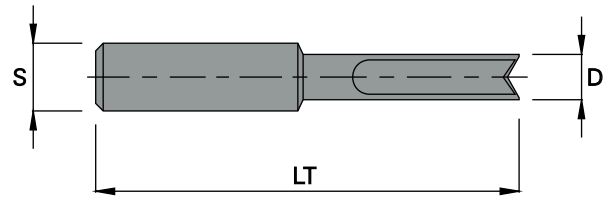

HL

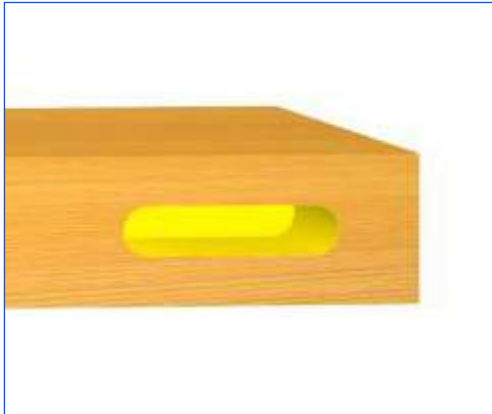

D	LT	S	Z	COD.
6	100	16x50	2	0510060000
7	100	16x50	2	0510070000
8	100	16x50	2	0510080000
9	100	16x50	2	0510090000
10	110	16x50	2	0510100000
11	110	16x50	2	0510110000
12	110	16x50	2	0510120000
13	110	16x50	2	0510130000
14	110	16x50	2	0510140000
15	110	16x50	2	0510150000
16	110	16x50	2	0510160000



Reciprocating slot mortise bit.



Broca para taladro pendular.



Mèche à mortaiser à taillants ambidextres.



Pendelschlitzbohrer.

# 511

## Punta per mortasare a taglienti ambidestri

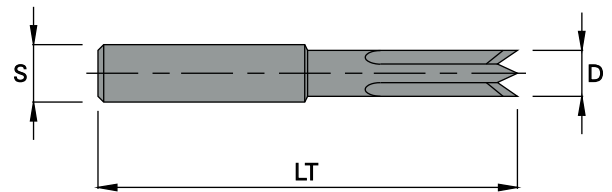

HL



D	LT	S	Z	COD.
6	73	10x40	4	0511060000
7	73	10x40	4	0511070000
8	73	10x40	4	0511080000
9	73	10x40	4	0511090000
10	73	10x40	4	0511100000
11	73	10x40	4	0511110000
12	73	10x40	4	0511120000
13	73	10x40	4	0511130000
14	73	10x40	4	0511140000
15	73	10x40	4	0511150000
16	73	10x40	4	0511160000



Reciprocating slot mortise bit.



Broca para taladro pendular.



Mèche à mortaiser à taillants ambidextres.



Pendelschlitzbohrer.

# 512

## Punta per mortasare a taglienti ambidestri

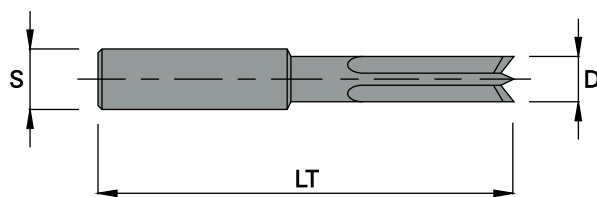

HL



D	LT	S	Z	COD.
6	100	13x50	4	0512060000
7	100	13x50	4	0512070000
8	100	13x50	4	0512080000
9	100	13x50	4	0512090000
10	110	13x50	4	0512100000
11	110	13x50	4	0512110000
12	110	13x50	4	0512120000
13	110	13x50	4	0512130000
14	110	13x50	4	0512140000
15	110	13x50	4	0512150000
16	110	13x50	4	0512160000

 Reciprocating slot mortise bit.

 Broca para taladro pendular.

 Mèche à mortaiser à taillants ambidextres.

 Pendelschlitzbohrer.

# 513

## Punta per mortasare a taglienti ambidestri

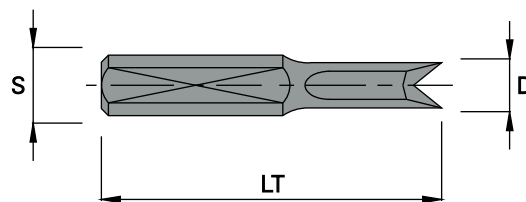

HL



D	LT	S	Z	COD.
6	60	12x30	2	0513060000
7	60	12x30	2	0513070000
8	60	12x30	2	0513080000
9	60	12x30	2	0513090000
10	60	12x30	4	0513100000
11	60	12x30	4	0513110000
12	60	12x30	4	0513120000

 Reciprocating slot mortise bit.

 Broca para taladro pendular.

 Mèche à mortaiser à taillants ambidextres.

 Pendelschlitzbohrer.

# 542

## Punta per esecuzione sede piastrina serrature

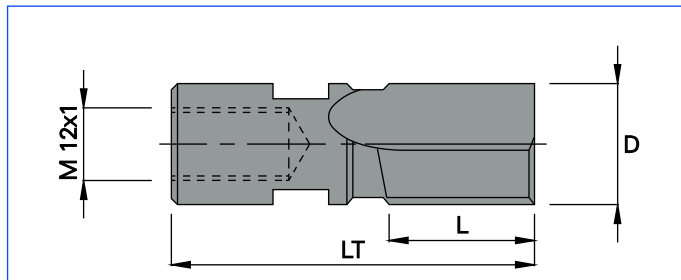

**HW**

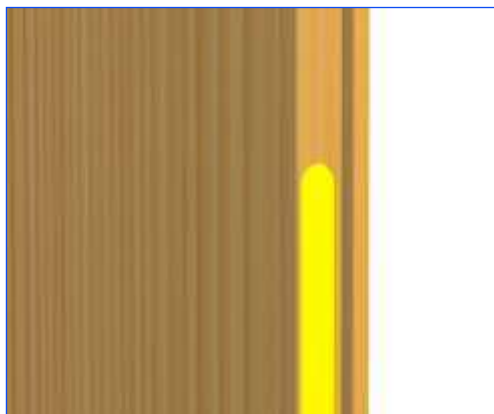

D	L	LT	Z	MAT.	COD. RH
20	25	60	2	HW	05422000HW
22	25	60	2	HW	05422200HW



Drill for locks.



Broca para herrajes.



Mèche pour serrures.



Bohrer für Schloss.

# 544

## Punta per esecuzione asola serrature

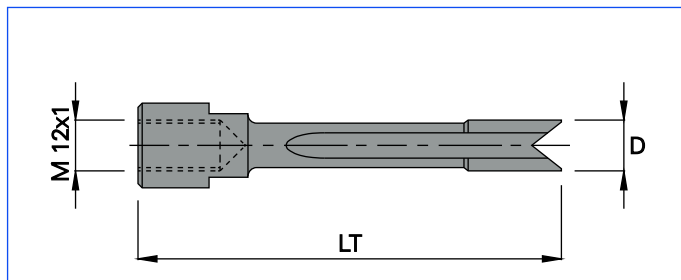
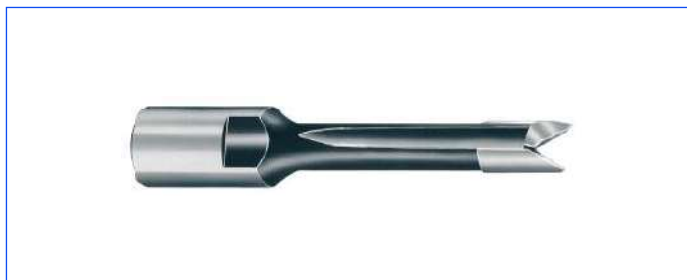

**HW**

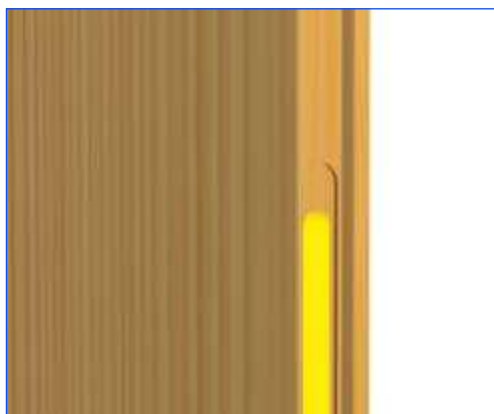

D	LT	Z	MAT.	COD. RH
12	100	2	HW	05441200HW
14	100	2	HW	05441400HW
16	100	2	HW	05441600HW
18	100	2	HW	05441800HW



Drill for locks.



Broca para herrajes.



Mèche pour serrures.



Bohrer für Schloss.

# 546

## Punta per esecuzione foro serrature

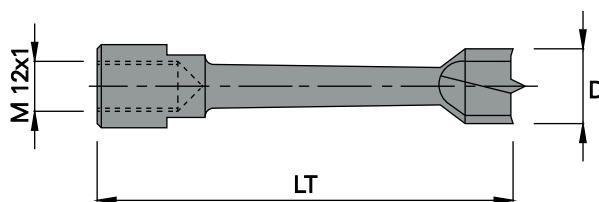

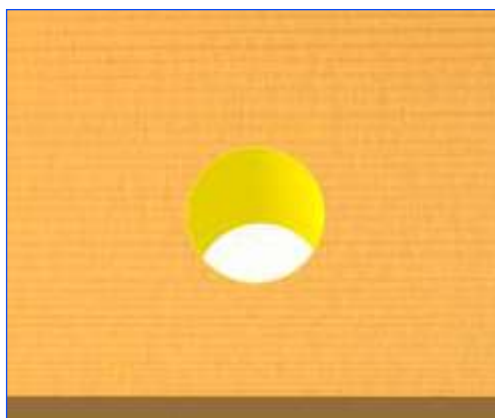

**HW**



D	LT	Z	MAT.	COD. RH
18	100	2	HW	05461800HW
20	100	2	HW	05462000HW
22	100	2	HW	05462200HW

 Drill for locks.

 Mecha para herrajes.

 Mèche pour serrures.

 Bohrer für Schloss.

# 548

## Punta per esecuzione asola e foro serrature

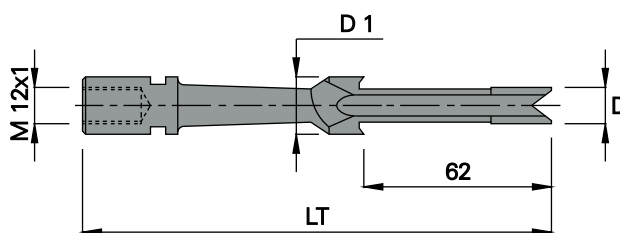

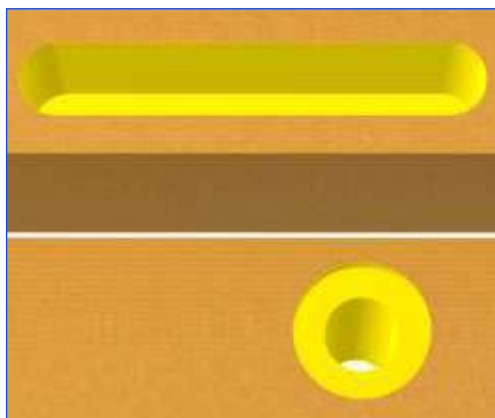

**HW**



D	D1	LT	Z	MAT.	COD. RH
10	18	155	2	HW	05481018HW
11	19	155	2	HW	05481119HW
12	19	155	2	HW	05481219HW

 Drill for locks.

 Mecha para herrajes.

 Mèche pour serrures.

 Bohrer für Schloss.

# 550 - A

## Mandrino per foratrice

attacco tipo : Biesse - Masterwood - Morbidelli - Reimall - Weeke.

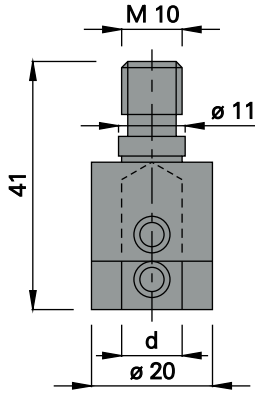

d	COD. RH	COD. LH
8	0550A080R0	0550A080L0
10	0550A100R0	0550A100L0

Ricambi / Spare parts / Rechanges / Repuestos / Ersatzteile

	M x L1	COD.
	M 5 x 5	048070P505
	E	COD.
	2.5	048078Z025

Chuck for dowel drills.  
Shank type : Biesse - Masterwood - Morbidelli - Reimall - Weeke.

Mandril para brocas.  
Mango tipo : Biesse - Masterwood - Morbidelli - Reimall - Weeke.

Mandrin pour mèches à tourillons.  
Queue type : Biesse - Masterwood - Morbidelli - Reimall - Weeke.

Bohrerspannfutter.  
Schaft Typ : Biesse - Masterwood - Morbidelli - Reimall - Weeke.

# 550 - B

## Mandrino per foratrice

attacco tipo : Ayen - Holzma - Knoevenagel - Mayer - Torwegge.

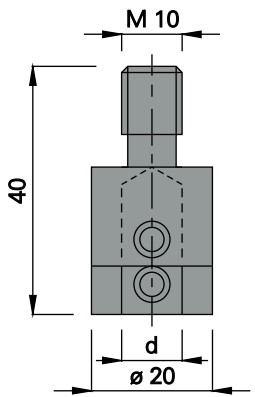

d	COD. RH	COD. LH
8	0550B080R0	0550B080L0
10	0550B100R0	0550B100L0

Ricambi / Spare parts / Rechanges / Repuestos / Ersatzteile

	M x L1	COD.
	M 5 x 5	048070P505
	E	COD.
	2.5	048078Z025

Chuck for dowel drills.  
Shank type : Ayen - Holzma - Knoevenagel - Mayer - Torwegge.

Mandril para brocas.  
Mango tipo : Ayen - Holzma - Knoevenagel - Mayer - Torwegge.

Mandrin pour mèches à tourillons.  
Queue type : Ayen - Holzma - Knoevenagel - Mayer - Torwegge.

Bohrerspannfutter.  
Schaft Typ : Ayen - Holzma - Knoevenagel - Mayer - Torwegge.

# 550 - C

## Mandrino per foratrice

attacco tipo : Nottmeyer (vecchio modello).

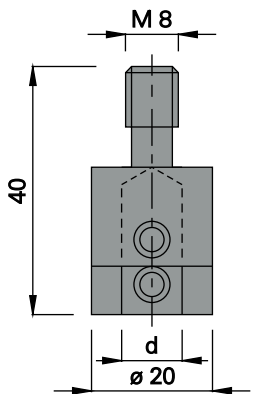

d	COD. RH	COD. LH
8	0550C080R0	0550C080L0
10	0550C100R0	0550C100L0

Ricambi / Spare parts / Rechanges / Repuestos / Ersatzteile

	M x L1	COD.
	M 5 x 5	048070P505
	E	COD.
	2.5	048078Z025

Chuck for dowel drills.  
Shank type : Nottmeyer (old model).

Mandril para brocas.  
Mango tipo : Nottmeyer (vejo modelo).

Mandrin pour mèches à tourillons.  
Queue type : Nottmeyer (vieu model).

Bohrerspannfutter.  
Schaft Typ : Nottmeyer (Altes Modell).

# 550 - E

## Mandrino per foratrice

attacco tipo : Masterwood - Morbidelli - Nottmeyer (nuovo modello).

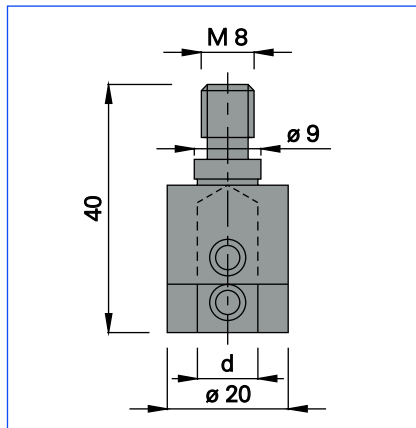

d	COD. RH	COD. LH
8	0550E080R0	0550E080L0
10	0550E100R0	0550E100L0

Ricambi / Spare parts / Rechanges / Repuestos / Ersatzteile

	M x L1	COD.
	M 5 x 5	048070P505
	E	COD.
	2.5	048078Z025

- |  |   |  |  |
|--|---|--|--|
|  | Chuck for dowel drills.<br>Shank type : Masterwood - Morbidelli - Nottmeyer (new model).                |  | Mandril para brocas.<br>Mango tipo : Masterwood - Morbidelli - Nottmeyer (nuevo modelo). |
|  | Mandrin pour mèches à tourillons.<br>Queue type : Masterwood - Morbidelli - Nottmeyer (nouveau modèle). |  | Bohrerspannfutter.<br>Schaft Typ : Masterwood - Morbidelli - Nottmeyer (Neues Modell).   |

# 552 - A

## Mandrino per foratrice

attacco tipo : Busellato - Ompec - Vitap.

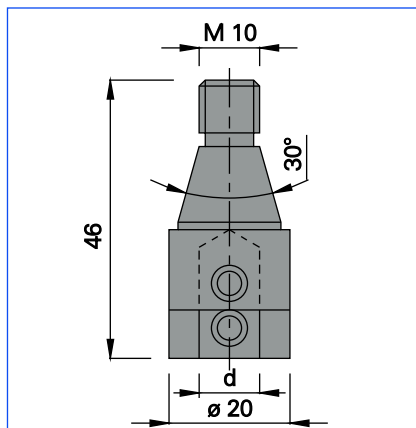

d	COD. RH	COD. LH
8	0552A080R0	0552A080L0
10	0552A100R0	0552A100L0

Ricambi / Spare parts / Rechanges / Repuestos / Ersatzteile

	M x L1	COD.
	M 5 x 5	048070P505
	E	COD.
	2.5	048078Z025

- |  |  |  |   |
|--|--|--|---|
|  | Chuck for dowel drills.<br>Shank type : Busellato - Ompec - Vitap.           |  | Mandril para brocas.<br>Mango tipo : Busellato - Ompec - Vitap. |
|  | Mandrin pour mèches à tourillons.<br>Queue type : Busellato - Ompec - Vitap. |  | Bohrerspannfutter.<br>Schaft Typ : Busellato - Ompec - Vitap.   |

# 552 - B

## Mandrino per foratrice

attacco tipo : Balestrini - Bilek.

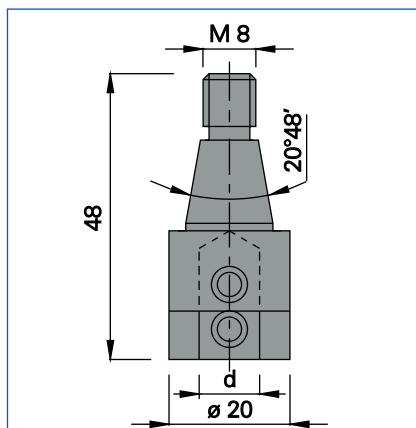

d	COD. RH	COD. LH
8	0552B080R0	0552B080L0
10	0552B100R0	0552B100L0

Ricambi / Spare parts / Rechanges / Repuestos / Ersatzteile

	M x L1	COD.
	M 5 x 5	048070P505
	E	COD.
	2.5	048078Z025

- |  |   |  |  |
|--|---|--|--|
|  | Chuck for dowel drills.<br>Shank type : Balestrini - Bilek.           |  | Mandril para brocas.<br>Mango tipo : Balestrini - Bilek. |
|  | Mandrin pour mèches à tourillons.<br>Queue type : Balestrini - Bilek. |  | Bohrerspannfutter.<br>Schaft Typ : Balestrini - Bilek.   |



# 552 - H

## Mandrino per foratrice

attacco tipo : Morbidelli.

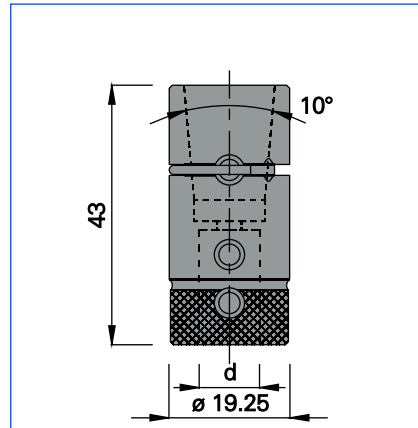

d	COD. RH / LH
10	0552H10000

### Ricambi / Spare parts / Rechanges / Repuestos / Ersatzteile

M	L 1	M x L1	COD.
		M 5 x 4	048070P504
E		E	COD.
		2.5	048078Z025



Chuck for dowel drills.  
Shank type : Morbidelli.



Mandril para brocas.  
Mango tipo : Morbidelli.



Mandrin pour mèches à tourillons.  
Queue type : Morbidelli.



Bohrerspannfutter.  
Schaft Typ : Morbidelli.

# 552 - L

## Mandrino per foratrice

attacco tipo : Biesse

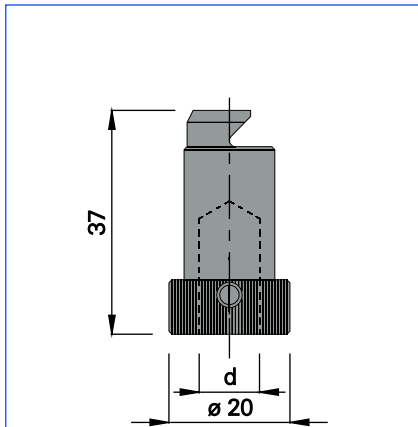

d	COD. RH	COD. LH
10	0552L100R0	0552L100L0

### Ricambi / Spare parts / Rechanges / Repuestos / Ersatzteile

M	L 1	M x L1	COD.
		M 6 x 6	048070P606
E		E	COD.
		3	048078Z030



Chuck for dowel drills.  
Shank type : Biesse.



Mandril para brocas.  
Mango tipo : Biesse.



Mandrin pour mèches à tourillons.  
Queue type : Biesse.



Bohrerspannfutter.  
Schaft Typ : Biesse.

# 552 - M

## Mandrino per foratrice

attacco tipo : Vitap (APA 70).

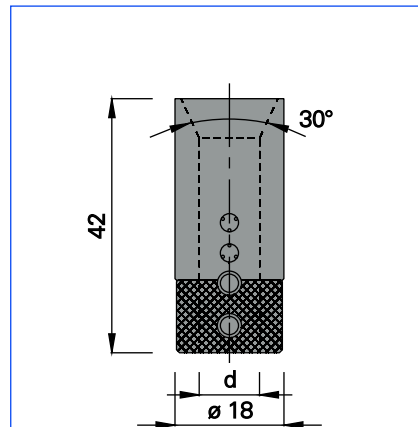

d	COD. RH / LH
10	0552M10000

### Ricambi / Spare parts / Rechanges / Repuestos / Ersatzteile

M	L 1	M x L1	COD.
		M 5 x 4	048070P504
E		E	COD.
		2.5	048078Z025



Chuck for dowel drills.  
Shank type : Vitap (APA 70).



Mandril para brocas.  
Mango tipo : Vitap (APA 70).



Mandrin pour mèches à tourillons.  
Queue type : Vitap (APA 70).



Bohrerspannfutter.  
Schaft Typ : Vitap (APA 70).

# 552 - P

## Mandrino per foratrice

attacco tipo : Masterwood.

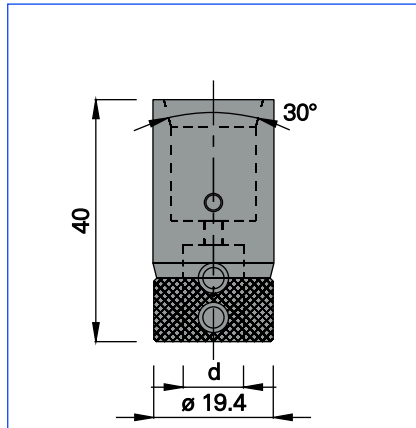

d	COD. RH / LH
10	0552P10000

Ricambi / Spare parts / Rechanges / Repuestos / Ersatzteile

	M x L1	COD.
	M 5 x 4	048070P504
	E	COD.
	2.5	048078Z025

Chuck for dowel drills.  
Shank type : Masterwood.

Mandril para brocas.  
Mango tipo : Masterwood.

Mandrin pour mèches à tourillons.  
Queue type : Masterwood.

Bohrerspannfutter.  
Schaft Typ : Masterwood.

# 556

## Punta componibile per cerniere

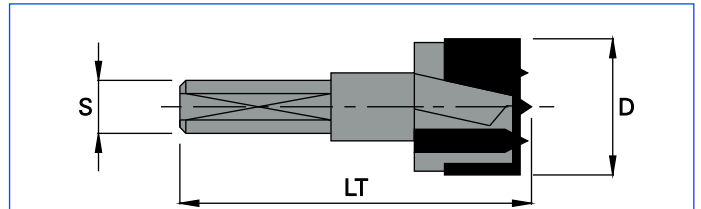

HW

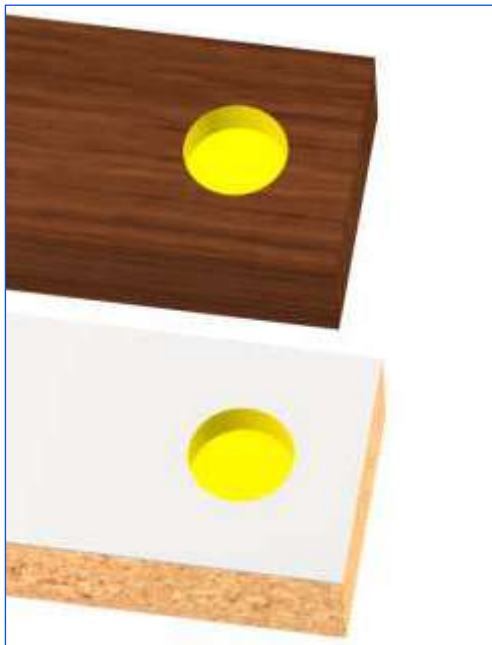

D	LT	S	Z	V	COD. RH	COD. LH
14	57.5	10x26	2	2	05561457R0	05561457L0
15	57.5	10x26	2	2	05561557R0	05561557L0
16	57.5	10x26	2	2	05561657R0	05561657L0
17	57.5	10x26	2	2	05561757R0	05561757L0
18	57.5	10x26	2	2	05561857R0	05561857L0
19	57.5	10x26	2	2	05561957R0	05561957L0
20	57.5	10x26	2	2	05562057R0	05562057L0
22	57.5	10x26	2	2	05562257R0	05562257L0
24	57.5	10x26	2	2	05562457R0	05562457L0
25	57.5	10x26	2	2	05562557R0	05562557L0
26	57.5	10x26	2	2	05562657R0	05562657L0
28	57.5	10x26	2	2	05562857R0	05562857L0
30	57.5	10x26	2	2	05563057R0	05563057L0
32	57.5	10x26	2	2	05563257R0	05563257L0
34	57.5	10x26	2	2	05563457R0	05563457L0
35	57.5	10x26	2	2	05563557R0	05563557L0
38	57.5	10x26	2	2	05563857R0	05563857L0
40	57.5	10x26	2	2	05564057R0	05564057L0
14	70	10x26	2	2	05561470R0	05561470L0
15	70	10x26	2	2	05561570R0	05561570L0
16	70	10x26	2	2	05561670R0	05561670L0
18	70	10x26	2	2	05561870R0	05561870L0
20	70	10x26	2	2	05562070R0	05562070L0
22	70	10x26	2	2	05562270R0	05562270L0
25	70	10x26	2	2	05562570R0	05562570L0
26	70	10x26	2	2	05562670R0	05562670L0
30	70	10x26	2	2	05563070R0	05563070L0
35	70	10x26	2	2	05563570R0	05563570L0
40	70	10x26	2	2	05564070R0	05564070L0

Ricambi / Spare parts / Rechanges / Repuestos / Ersatzteile

	M x L1	COD.
	M 5 x 10	048070C510

Hinge boring bit.

Broca para bisagras.

Mèche à tête cylindrique.

Beschlagbohrer.

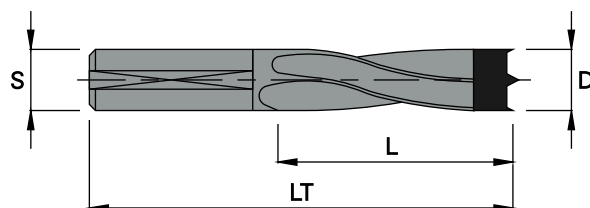

HW

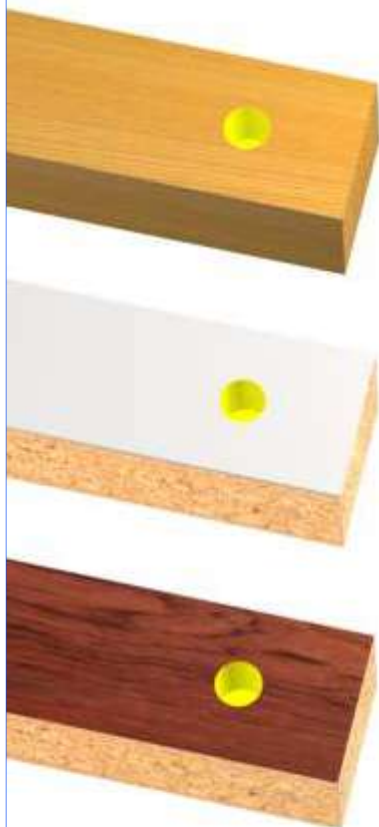

D	L	LT	S	Z	COD. RH	COD. LH
5	30	57.5	10x20	2	05580530R0	05580530L0
6	30	57.5	10x20	2	05580630R0	05580630L0
7	30	57.5	10x20	2	05580730R0	05580730L0
8	30	57.5	10x20	2	05580830R0	05580830L0
9	30	57.5	10x20	2	05580930R0	05580930L0
10	30	57.5	10x20	2	05581030R0	05581030L0
12	30	57.5	10x20	2	05581230R0	05581230L0
14	30	57.5	10x20	2	05581430R0	05581430L0
15	30	57.5	10x20	2	05581530R0	05581530L0
16	30	57.5	10x20	2	05581630R0	05581630L0
5	43	70	10x20	2	05580543R0	05580543L0
6	43	70	10x20	2	05580643R0	05580643L0
7	43	70	10x20	2	05580743R0	05580743L0
8	43	70	10x20	2	05580843R0	05580843L0
9	43	70	10x20	2	05580943R0	05580943L0
10	43	70	10x20	2	05581043R0	05581043L0
12	43	70	10x20	2	05581243R0	05581243L0
14	43	70	10x20	2	05581443R0	05581443L0
15	43	70	10x20	2	05581543R0	05581543L0
16	43	70	10x20	2	05581643R0	05581643L0
10	65	105	10x30	2	05581065R0	05581065L0
12	65	105	10x30	2	05581265R0	05581265L0
14	65	105	10x25	2	05581465R0	05581465L0

## Ricambi / Spare parts / Rechanges / Repuestos / Ersatzteile

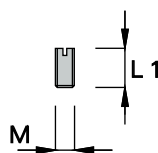

M x L 1

COD.

M 5 x 10

048070C510



Dowel drill for blind holes.



Broca para agujeros ciegos.



Mèche à percer.



Dübelbohrer.

# 559

## Punta componibile per fori ciechi in metallo duro integrale

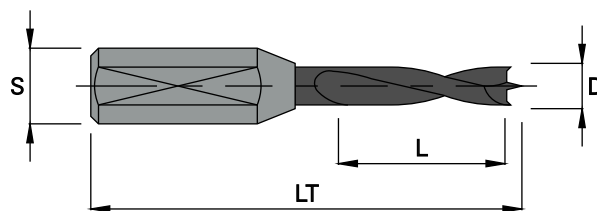

**HW**

D	L	LT	S	Z	COD. RH	COD. LH
3	18	57.5	10x31	2	05590315R0	05590315L0
4	20	57.5	10x29	2	05590422R0	05590422L0
5	22	57.5	10x27	2	05590522R0	05590522L0
6	22	57.5	10x27	2	05590622R0	05590622L0
8	27	57.5	10x27	2	05590822R0	05590822L0
3	18	70	10x43	2	05590318R0	05590318L0
4	27	70	10x34	2	05590427R0	05590427L0
5	30	70	10x31	2	05590527R0	05590527L0
6	30	70	10x31	2	05590627R0	05590627L0
8	35	70	10x30	2	05590827R0	05590827L0

### Ricambi / Spare parts / Rechanges / Repuestos / Ersatzteile

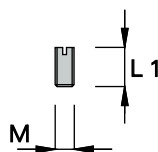

M x L 1	COD.
M 5 x 10	048070C510

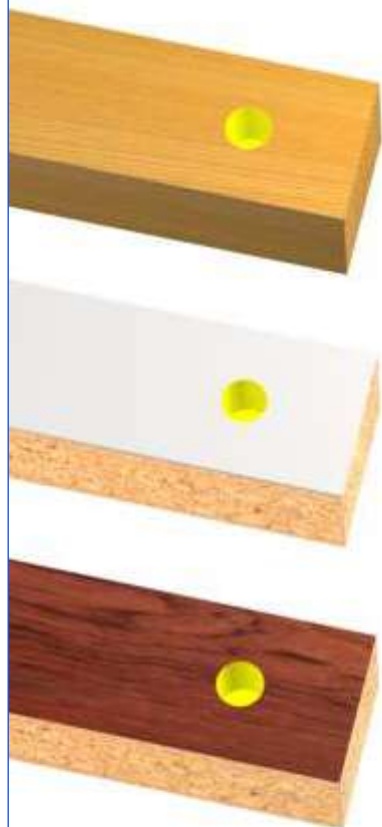

 Dowel drill in solid carbide for blind holes.

 Broca de metal duro macizo para agujeros ciegos.

 Mèche à percer en carbure integral.

 Dübelbohrer in Hartmetall - massiv.

# 560

## Punta componibile per fori passanti

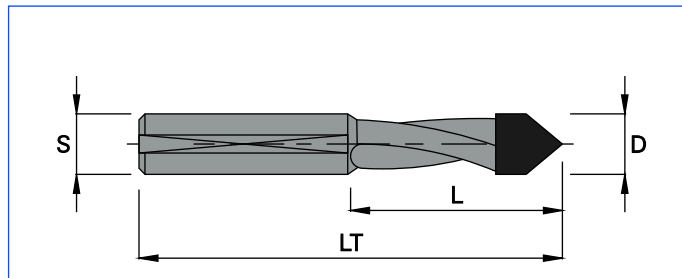

**HW**



D	L	LT	S	Z	COD. RH	COD. LH
5	27	57.5	10x26	2	05600527R0	05600527L0
6	27	57.5	10x26	2	05600627R0	05600627L0
8	27	57.5	10x26	2	05600827R0	05600827L0
10	27	57.5	10x26	2	05601027R0	05601027L0
5	35	70	10x26	2	05600535R0	05600535L0
6	35	70	10x26	2	05600635R0	05600635L0
8	35	70	10x26	2	05600835R0	05600835L0
10	35	70	10x26	2	05601035R0	05601035L0
12	35	70	10x26	2	05601235R0	05601235L0

Ricambi / Spare parts / Rechanges / Repuestos / Ersatzteile

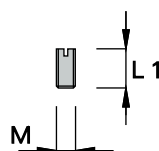

M x L 1

COD.

M 5 x 10

048070C510

# 561

## Punta componibile per fori passanti in metallo duro integrale

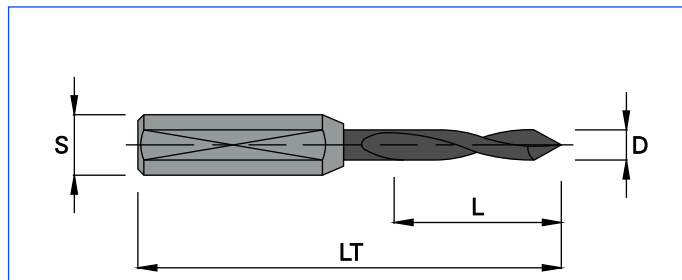

**HW**



D	L	LT	S	Z	COD. RH	COD. LH
4	40	70	10x20	2	05610440R0	05610440L0
5	40	70	10x20	2	05610540R0	05610540L0

Ricambi / Spare parts / Rechanges / Repuestos / Ersatzteile

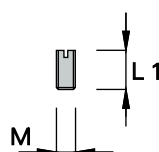

M x L 1

COD.

M 5 x 10

048070C510



Dowel drill for through holes.



Broca para agujeros pasantes.



Mèche à percer.



Durchgangslochbohrer.

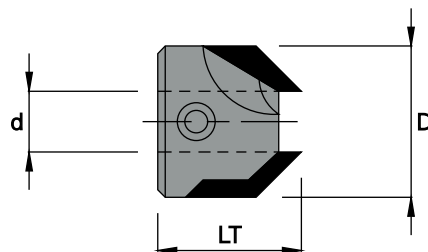

HW

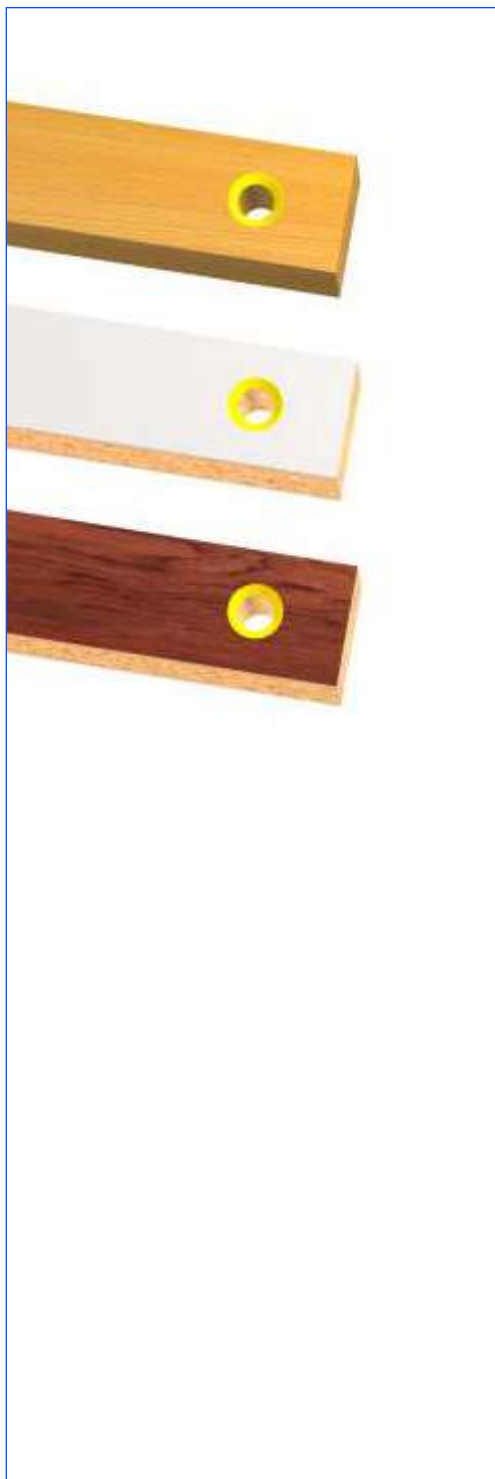

d	D	LT	Z	COD. RH	COD. LH
5	16	16.5	2	05620500R0	05620500L0
6	16	16.5	2	05620600R0	05620600L0
7	16	16.5	2	05620700R0	05620700L0
8	18	16.5	2	05620800R0	05620800L0
9	18	16.5	2	05620900R0	05620900L0
10	20	16.5	2	05621000R0	05621000L0
12	20	16.5	2	05621200R0	05621200L0

Ricambi / Spare parts / Rechanges / Repuestos / Ersatzteile

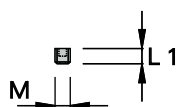

M x L 1

COD.

M 5 x 5

048070P505



E

COD.

2.5

048078Z025

 Countersink.

 Avellanador.

 Fraisoir.

 Aufstecksenker.

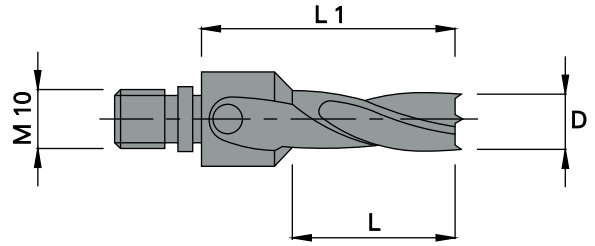

### HL - HW

#### HL

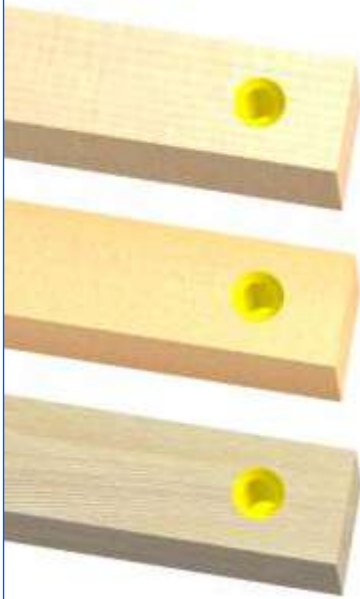

#### HW

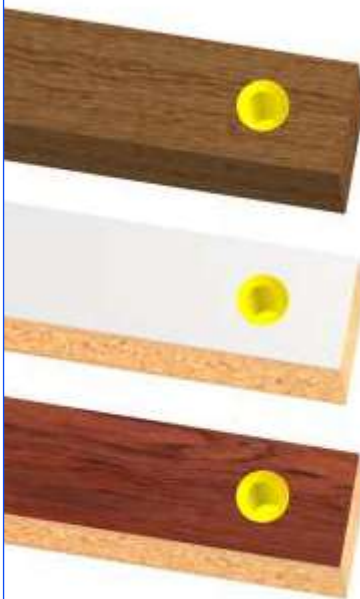

D	L	L1	Z	MAT.	COD. RH	COD. LH
5	30	45	2	HL	05640530RL	05640530LL
6	30	45	2	HL	05640630RL	05640630LL
8	30	45	2	HL	05640830RL	05640830LL
10	30	45	2	HL	05641030RL	05641030LL
12	30	45	2	HL	05641230RL	05641230LL
5	30	45	2	HW	05640530RW	05640530LW
6	30	45	2	HW	05640630RW	05640630LW
8	30	45	2	HW	05640830RW	05640830LW
10	30	45	2	HW	05641030RW	05641030LW
12	30	45	2	HW	05641230RW	05641230LW
5	40	55	2	HL	05640540RL	05640540LL
6	40	55	2	HL	05640640RL	05640640LL
8	40	55	2	HL	05640840RL	05640840LL
10	40	55	2	HL	05641040RL	05641040LL
12	40	55	2	HL	05641240RL	05641240LL
5	40	55	2	HW	05640540RW	05640540LW
6	40	55	2	HW	05640640RW	05640640LW
8	40	55	2	HW	05640840RW	05640840LW
10	40	55	2	HW	05641040RW	05641040LW
12	40	55	2	HW	05641240RW	05641240LW



Dowel drill with countersink for blind holes.  
Shank type : Biesse - Gessner - Masterwood - Morbidelli - Torwegge - Weeke.



Broca para agujeros ciegos.  
Mango tipo : Biesse - Gessner - Masterwood - Morbidelli - Torwegge - Weeke.



Mèche à percer avec fraisoir.  
Queue type : Biesse - Gessner - Masterwood - Morbidelli - Torwegge - Weeke.



Dübelbohrer mit Gewindenschaft und Aufstecksenker.  
Schaft typ : Biesse - Gessner - Masterwood - Morbidelli - Torwegge - Weeke.

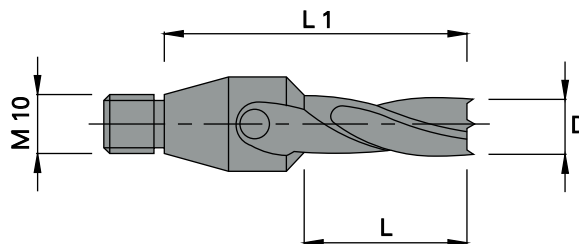

## HL - HW

### HL

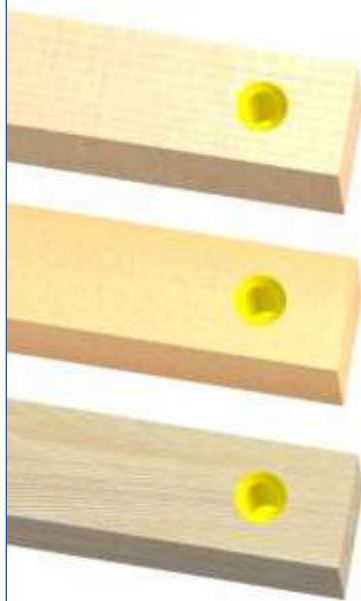

### HW



D	L	L1	Z	MAT.	COD. RH	COD. LH
5	30	55	2	HL	05660530RL	05660530LL
6	30	55	2	HL	05660630RL	05660630LL
8	30	55	2	HL	05660830RL	05660830LL
10	30	55	2	HL	05661030RL	05661030LL
12	30	55	2	HL	05661230RL	05661230LL
5	30	55	2	HW	05660530RW	05660530LW
6	30	55	2	HW	05660630RW	05660630LW
8	30	55	2	HW	05660830RW	05660830LW
10	30	55	2	HW	05661030RW	05661030LW
12	30	55	2	HW	05661230RW	05661230LW
5	40	65	2	HL	05660540RL	05660540LL
6	40	65	2	HL	05660640RL	05660640LL
8	40	65	2	HL	05660840RL	05660840LL
10	40	65	2	HL	05661040RL	05661040LL
12	40	65	2	HL	05661240RL	05661240LL
5	40	65	2	HW	05660540RW	05660540LW
6	40	65	2	HW	05660640RW	05660640LW
8	40	65	2	HW	05660840RW	05660840LW
10	40	65	2	HW	05661040RW	05661040LW
12	40	65	2	HW	05661240RW	05661240LW



Dowel drill with countersink for blind holes.  
Shank type : Bilex - Busellato - Dubelfix - Ompec - Schleicher - Vitap.



Mèche à percer avec fraisoir.  
Queue type : Bilex - Busellato - Dubelfix - Ompec - Schleicher - Vitap.



Broca para agujeros ciegos.  
Mango tipo : Bilex - Busellato - Dubelfix - Ompec - Schleicher - Vitap.



Dübelbohrer mit Gewindenschaft und Aufstecksenkter.  
Schaft typ : Bilex - Busellato - Dubelfix - Ompec - Schleicher - Vitap.



# 568 - A

## Mandrino

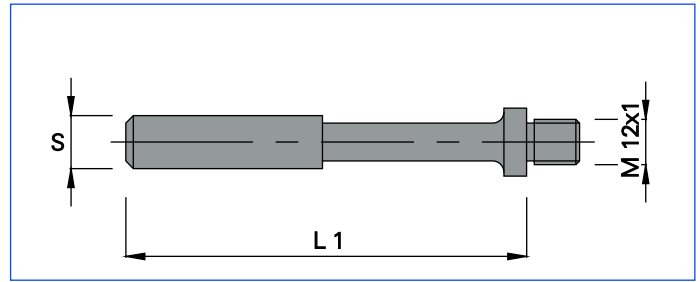

--	--

--

S	L 1	COD. RH	COD. LH
10x20	27	0568A1020R	0568A1020L
10x35	40	0568A1035R	0568A1035L
10x50	60	0568A1050R	-
13x50	100	0568A130R0	0568A130L0
16x50	100	0568A160R0	0568A160L0

# 568 - B

## Mandrino

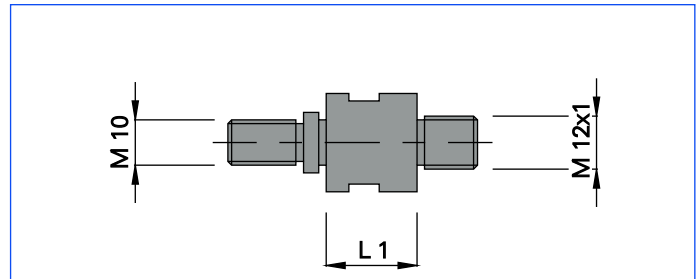

--	--

--

L 1	COD. RH	COD. LH
15	0568B150R0	0568B150L0
25	0568B250R0	0568B250L0
35	0568B350R0	0568B350L0

# 568 - C

## Mandrino

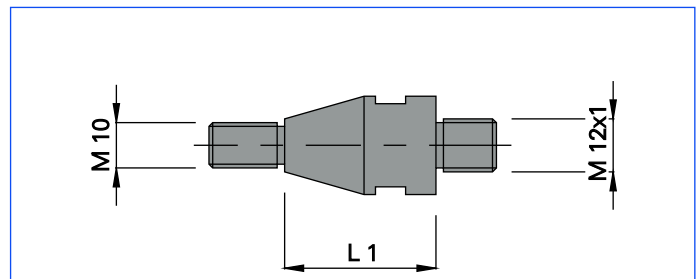

--	--

--

L 1	COD. RH	COD. LH
25	0568C250R0	0568C250L0
35	0568C350R0	0568C350L0
45	0568C450R0	0568C450L0

Adaptor.

Mandril.

Mandrin.

Spannfutter.

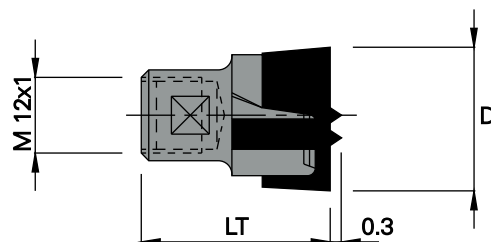

HW



D	LT	Z	V	COD. RH	COD. LH
20	30	2	2	05702000R0	05702000L0
22	30	2	2	05702200R0	05702200L0
24	30	2	2	05702400R0	05702400L0
25	30	2	2	05702500R0	05702500L0
26	30	2	2	05702600R0	05702600L0
30	30	2	2	05703000R0	05703000L0
32	30	2	2	05703200R0	05703200L0
34	30	2	2	05703400R0	05703400L0
35	30	2	2	05703500R0	05703500L0
36	30	2	2	05703600R0	05703600L0
38	30	2	2	05703800R0	05703800L0
40	30	2	2	05704000R0	05704000L0
45	30	2	2	05704500R0	05704500L0
50	30	2	2	05705000R0	05705000L0
55	30	2	2	05705500R0	05705500L0
60	30	2	2	05706000R0	05706000L0

 Hinge boring bit.

 Broca para bisagras.

 Mèche à tête cylindrique.

 Beschlagbohrer.

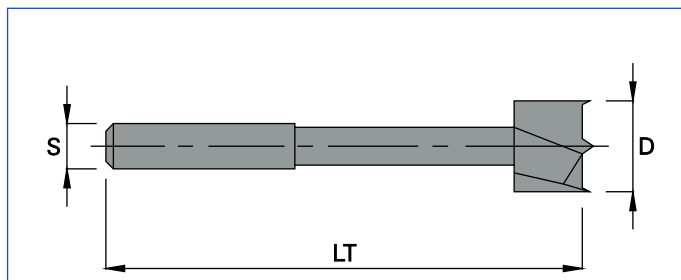

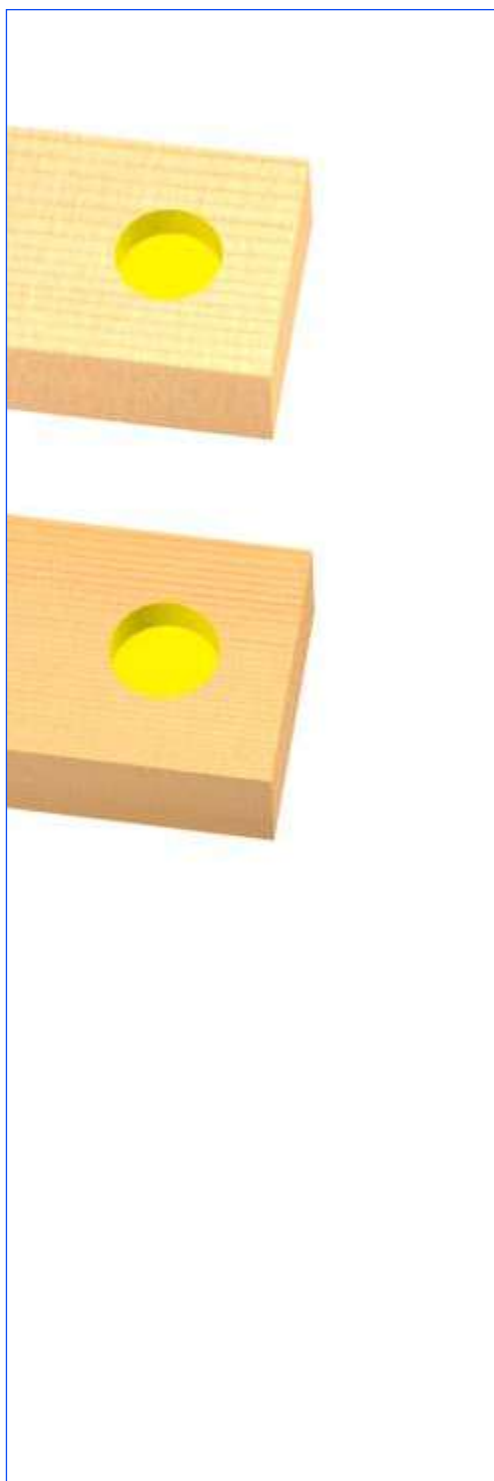

HL



D	LT	S	Z	V	COD. RH
8	120	13x50	2	2	05720813R0
8	120	16x50	2	2	05720816R0
10	120	13x50	2	2	05721013R0
10	120	16x50	2	2	05721016R0
12	120	13x50	2	2	05721213R0
12	120	16x50	2	2	05721216R0
14	120	13x50	2	2	05721413R0
14	120	16x50	2	2	05721416R0
15	120	13x50	2	2	05721513R0
15	120	16x50	2	2	05721516R0
16	120	13x50	2	2	05721613R0
16	120	16x50	2	2	05721616R0
18	120	13x50	2	2	05721813R0
18	120	16x50	2	2	05721816R0
20	120	13x50	2	2	05722013R0
20	120	16x50	2	2	05722016R0
25	125	13x50	2	2	05722513R0
25	125	16x50	2	2	05722516R0
26	125	13x50	2	2	05722613R0
26	125	16x50	2	2	05722616R0
30	130	13x50	2	2	05723013R0
30	130	16x50	2	2	05723016R0
35	130	13x50	2	2	05723513R0
35	130	16x50	2	2	05723516R0
38	130	13x50	2	2	05723813R0
38	130	16x50	2	2	05723816R0
40	130	13x50	2	2	05724013R0
40	130	16x50	2	2	05724016R0

 Hinge boring bit.

 Broca para bisagras.

 Mèche à tête cylindrique.

 Beschlagbohrer.

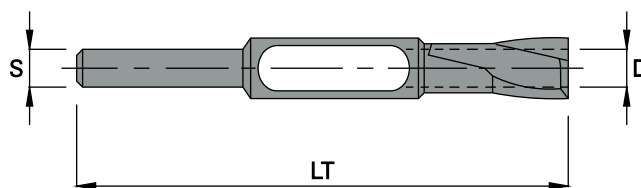

HL

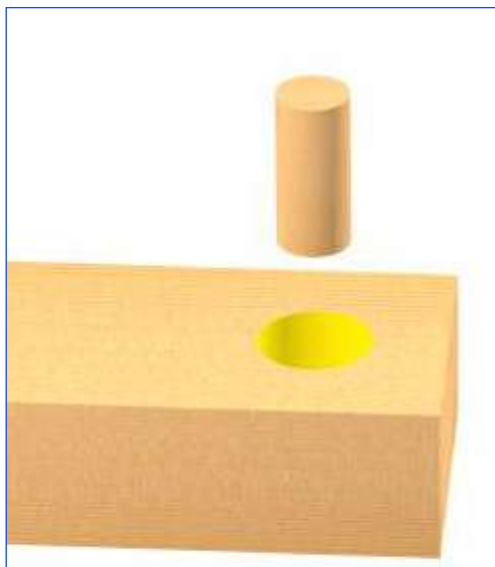

D	LT	S	Z	COD. RH
8	140	13x50	4	0567080000
10	140	13x50	4	0567100000
12	140	13x50	4	0567120000
14	140	13x50	4	0567140000
15	140	13x50	4	0567150000
16	140	13x50	4	0567160000
18	140	13x50	4	0567180000
20	140	13x50	4	0567200000
25	140	13x50	5	0567250000
30	140	13x50	5	0567300000
35	140	16x50	6	0567350000
40	140	16x50	6	0567400000

Plug cutter.

Cortador para tapones.

Mèche à tampons.

Scheibenschneider.

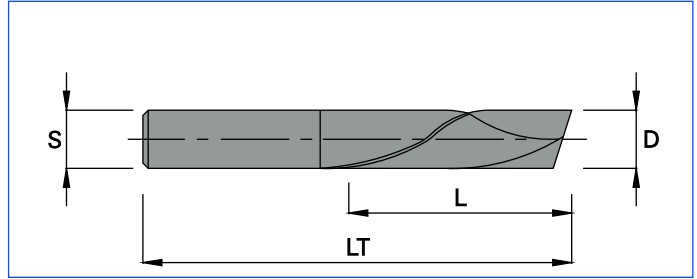

**HW**

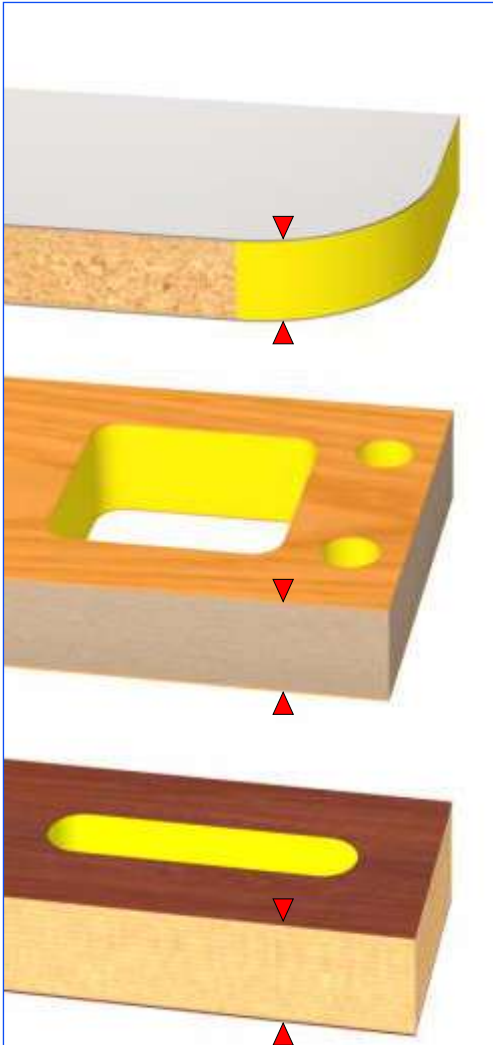

▲ = finitura migliore.



Better finish.



Finissage meilleur.



Acabado mejor.



Feinbearbeitung.

D	L	LT	S	Z	COD. RH
8	32	80	8	1+1	06060832R0
10	32	80	10	1+1	06061032R0
10	42	100	10	1+1	06061042R0
12	42	100	12	1+1	06061242R0
12	52	100	12	1+1	06061252R0
14	42	100	14	2+2	06061442R0
14	52	110	14	2+2	06061452R0
16	42	100	16	2+2	06061642R0
16	52	110	16	2+2	06061652R0
16	72	130	16	2+2	06061672R0
18	52	120	18	2+2	06061852R0
18	72	140	18	2+2	06061872R0
20	52	130	20	2+2	06062052R0
20	72	140	20	2+2	06062072R0



Up - down cut solid carbide spiral bit.



Fresa helicoidal positiva - negativa de metal duro macizo.



Fraise hélicoidale positive - négative en carbure massif.



Hartmetall - massive - Oberfräser mit positiven und negativen Spiralschneiden.

# 610 Fresa elicoidale positiva in metallo duro integrale

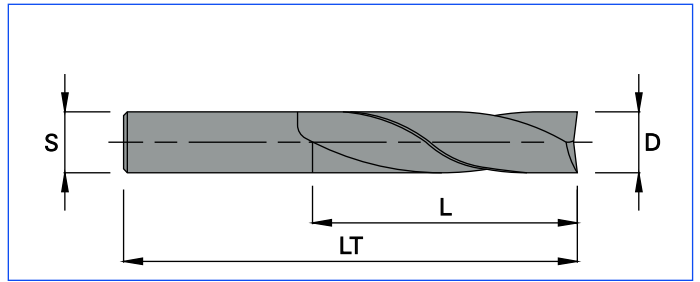

HW

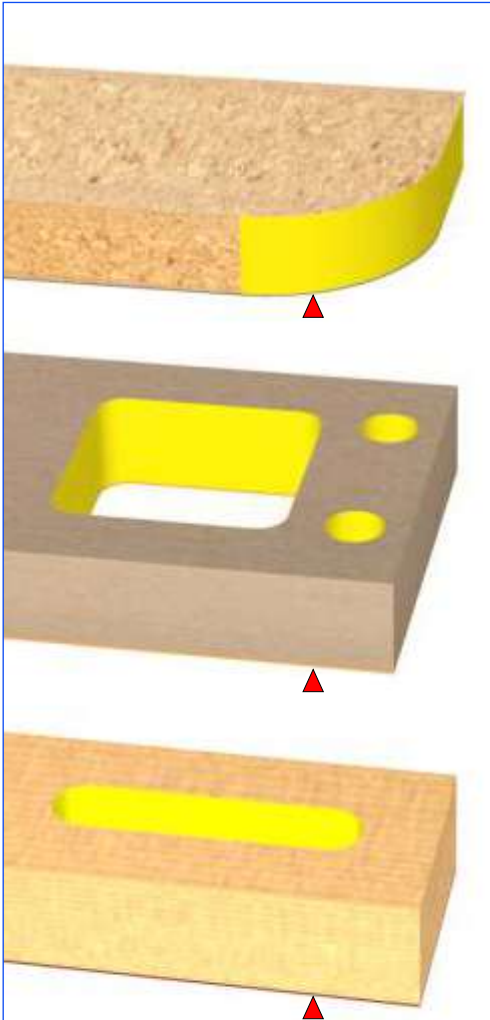

▲ = finitura migliore.

 Better finish.

 Finissage meilleur.

 Acabado mejor.

 Feinbearbeitung.

D	L	LT	S	Z	COD. RH
3	12	50	3	2	06100312R0
4	12	50	4	2	06100412R0
5	17	50	5	2	06100517R0
6	22	60	6	2	06100622R0
6	27	60	6	2	06100627R0
8	22	70	8	2	06100822R0
8	32	80	8	2	06100832R0
8	42	90	8	2	06100842R0
10	32	80	10	2	06101032R0
10	42	90	10	2	06101042R0
10	52	100	10	2	06101052R0
12	32	80	12	2	06101232R0
12	42	90	12	2	06101242R0
12	52	100	12	2	06101252R0
14	32	80	14	2	06101432R0
14	52	100	14	2	06101452R0
16	42	90	16	2	06101642R0
16	52	100	16	2	06101652R0
16	72	120	16	2	06101672R0
18	72	120	18	2	06101872R0
20	72	120	20	2	06102072R0

 Up - cut solid carbide spiral bit.

 Fresa helicoidal positiva de metal duro macizo.

 Fraise hélicoidale positive en carbure massif.

 Hartmetall - massive - Oberfräser mit positiven Spiralschneiden.

# 612 Fresa elicoidale positiva in metallo duro integrale

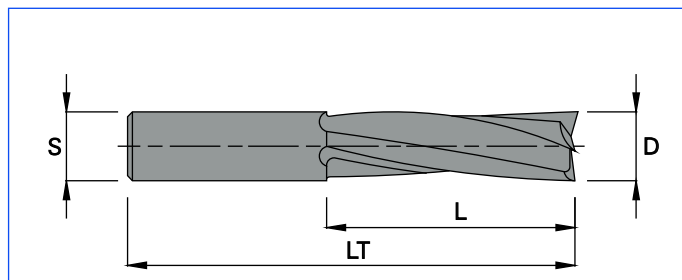

**HW**

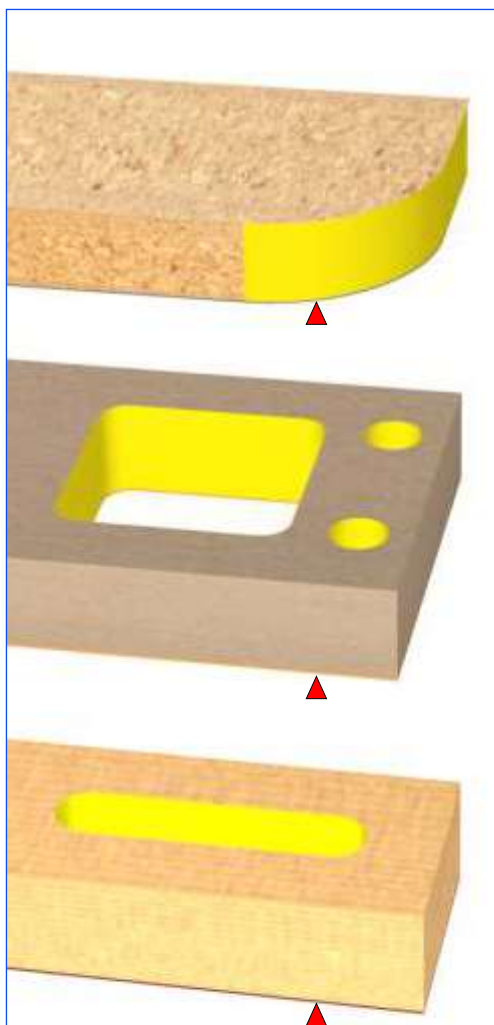

▲ = finitura migliore.



Better finish.



Finissage meilleur.



Acabado mejor.



Feinbearbeitung.

D	L	LT	S	Z	COD. RH
8	22	70	8	3	06120822R0
8	32	80	8	3	06120832R0
10	32	80	10	3	06121032R0
10	42	90	10	3	06121042R0
12	32	80	12	3	06121232R0
12	42	90	12	3	06121242R0
12	52	100	12	3	06121252R0
14	42	90	14	3	06121442R0
14	52	100	14	3	06121452R0
16	42	90	16	3	06121642R0
16	52	100	16	3	06121652R0
16	72	120	16	3	06121672R0
18	52	100	18	3	06121852R0
18	72	120	18	3	06121872R0
18	102	150	18	3	06121810R0
20	52	100	20	3	06122052R0
20	72	120	20	3	06122072R0
20	102	150	20	3	06122010R0



Up - cut solid carbide spiral bit.



Fresa helicoidal positiva de metal duro macizo.



Fraise hélicoidale positive en carbure massif.



Hartmetall - massive - Oberfräser mit positiven Spiralschneiden.

# 614 Fresa elicoidale positiva in metallo duro integrale con rompitruciolo

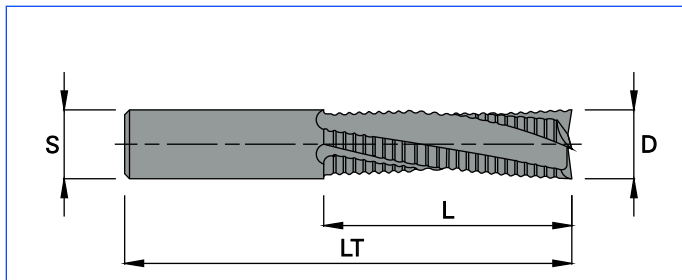

**HW**

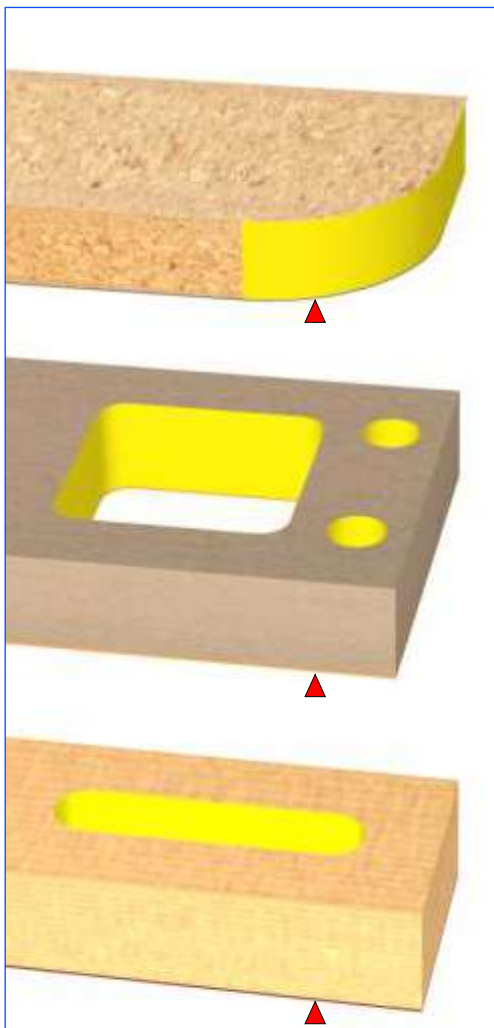

▲ = finitura migliore.



Better finish.



Finissage meilleur.



Acabado mejor.



Feinbearbeitung.

D	L	LT	S	Z	COD. RH
8	22	70	8	3	06140822R0
8	32	80	8	3	06140832R0
10	32	80	10	3	06141032R0
10	42	90	10	3	06141042R0
12	32	80	12	3	06141232R0
12	42	90	12	3	06141242R0
12	52	100	12	3	06141252R0
14	42	90	14	3	06141442R0
14	52	100	14	3	06141452R0
16	42	90	16	3	06141642R0
16	52	100	16	3	06141652R0
16	72	120	16	3	06141672R0
18	52	100	18	3	06141852R0
18	72	120	18	3	06141872R0
18	102	150	18	3	06141810R0
20	52	100	20	3	06142052R0
20	72	120	20	3	06142072R0
20	102	150	20	3	06142010R0



Up - cut solid carbide spiral bit with chip - breaker.



Fresa helicoidal positiva de metal duro macizo con rompevirutas.



Fraise hélicoidale positive en carbure massif avec brise - copeaux.



Hartmetall - massive - Oberfräser mit positiven Spiralschneiden und mit Spanbrechern.



# 615 Fresa elicoidale positiva in metallo duro integrale con rompitruciolo

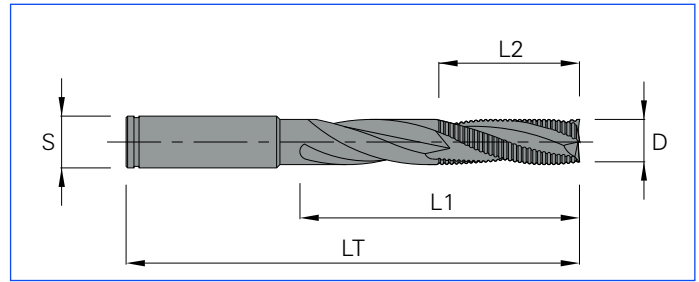
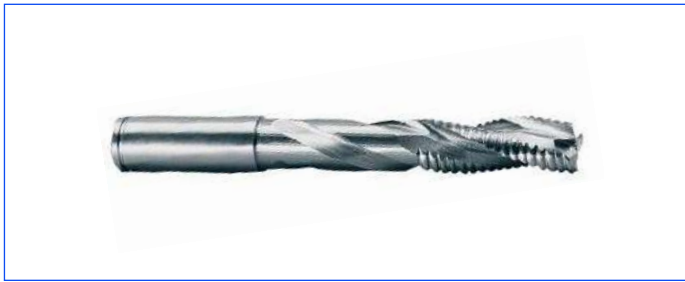

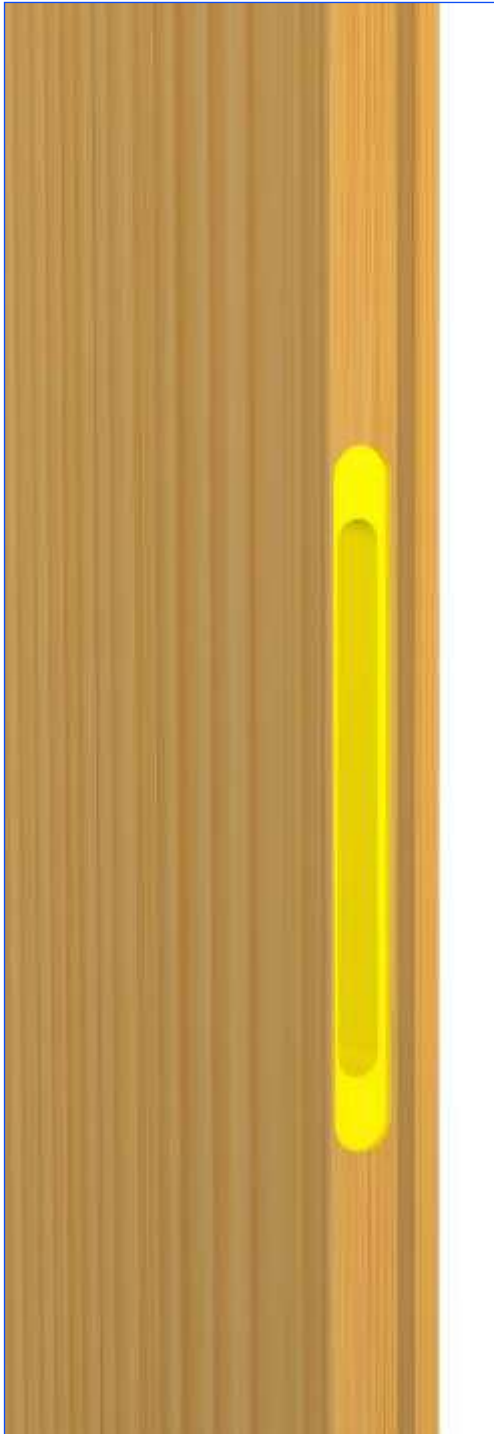

**HW**



D	L1	L2	LT	S	Z	COD. RH
12	95	45	150	12	3	06151200R0
14	95	45	150	14	3	06151400R0
16	95	45	150	16	3	06151600R0
18	95	45	150	18	3	06151800R0
20	95	45	150	20	3	06152000R0

 Up - cut solid carbide spiral bit with chip - breaker.

 Fresa helicoidal positiva de metal duro macizo con rompevirutas.

 Fraise hélicoidale positive en carbure massif avec brise - copeaux.

 Hartmetall - massive - Oberfräser mit positiven Spiralschneiden und mit Spanbrechern.

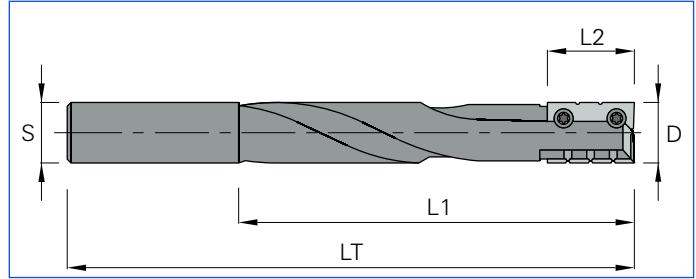

**HW**

D	L1	L2	LT	S	Z	COD. RH
16	95	23	150	16	2	0615F160R0

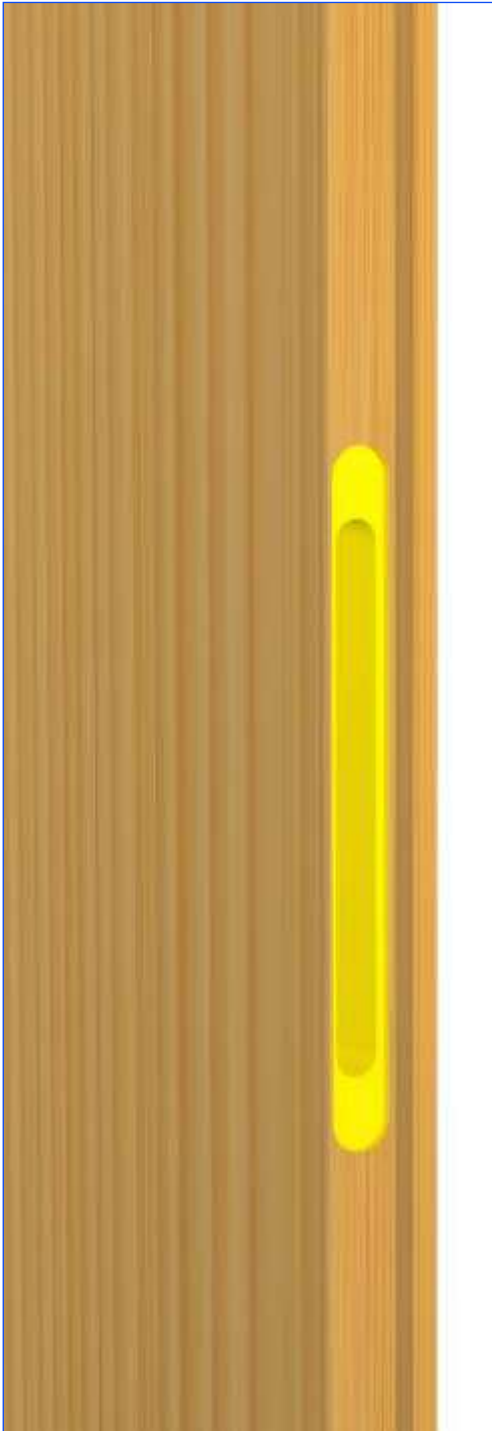

**Ricambi / Spare parts / Rechanges / Repuestos / Ersatzteile**

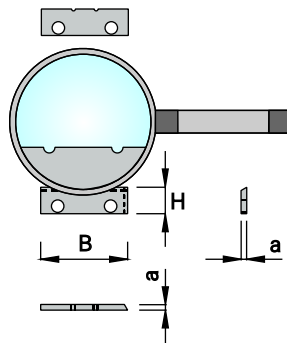

B	H	a	COD.
23	7	1.5	048115FA00

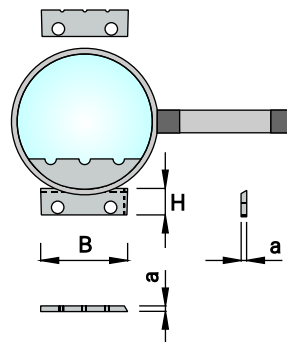

B	H	a	COD.
23	7	1.5	048115FB00

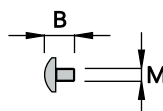



M x B	COD.
3 x 4	048074F304



COD.
TORX T9
048020F000

 Router cutter with throwaway knives and chip - breaker.

 Fresa router con cuchillas y rompevirutas.

 Fraise usinage boîtier de serrure avec plaquettes à jeter avec brise - coupeaux.

 Oberfräser mit Messern und Spanbrechern.

# 615 - A

## Fresa elicoidale positiva in metallo duro integrale

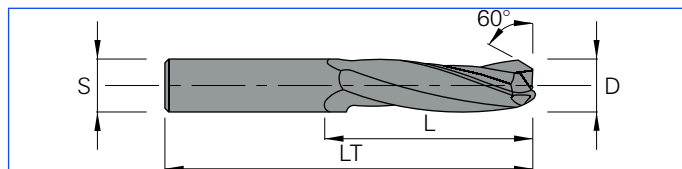

**HW**

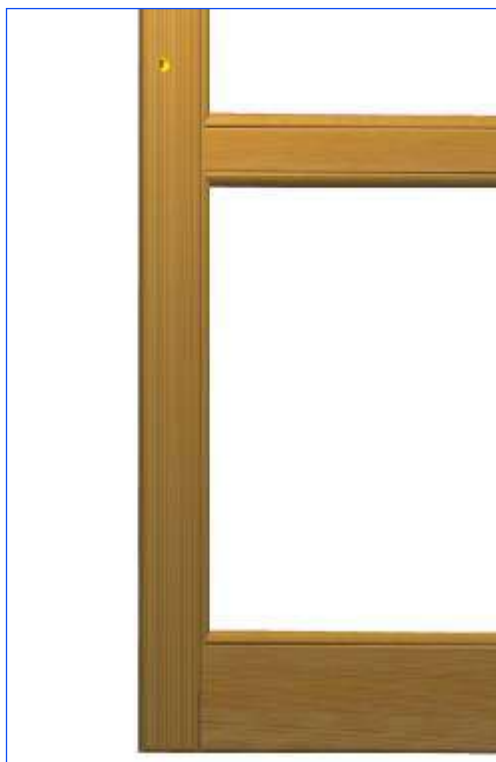

D	L	LT	S	Z	COD. RH
14	50	110	14	3	0615A140R0
16	55	110	16	3	0615A160R0

 Up - cut solid carbide spiral bit.

 Fresa helicoidal positiva de metal duro macizo.

 Fraise hélicoidale positive en carbure massif.

 Hartmetall - massive - Oberfräser mit positiven Spiralschneiden.

# 615 - B

## Fresa elicoidale positiva in metallo duro integrale con rompitruciolo

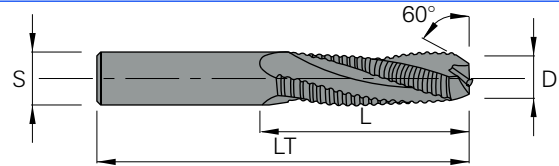

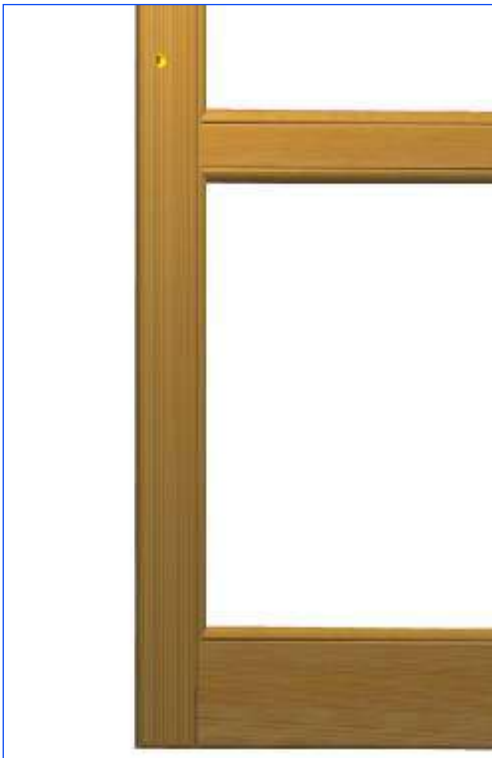

**HW**



D	L	LT	S	Z	COD. RH
14	58	110	14	3	0615B140R0
16	55	110	16	3	0615B160R0

 Up - cut solid carbide spiral bit with chip - breaker.

 Fresa helicoidal positiva de metal duro macizo con rompevirutas.

 Fraise hélicoidale positive en carbure massif avec brise - copeaux.

 Hartmetall - massive - Oberfräser mit positiven Spiralschneiden und mit Spanbrechern.

# 616 Fresa elicoidale negativa in metallo duro integrale

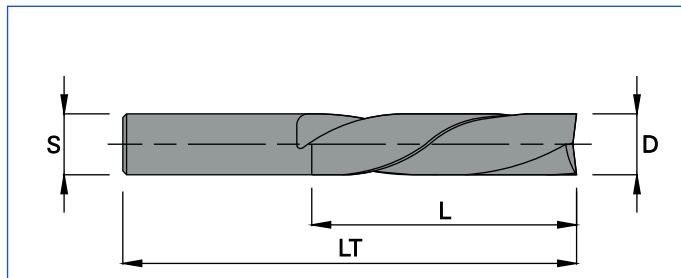

**HW**

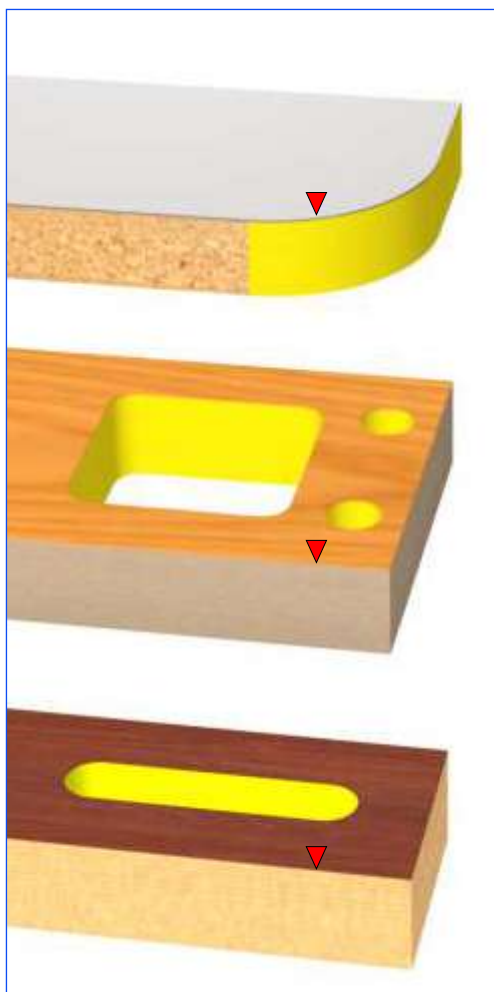

▲ = finitura migliore.



Better finish.



Finissage meilleur.



Acabado mejor.



Feinbearbeitung.

D	L	LT	S	Z	COD. RH
3	12	50	3	2	06160312R0
4	12	50	4	2	06160412R0
5	17	50	5	2	06160517R0
6	22	60	6	2	06160622R0
6	27	60	6	2	06160627R0
8	22	70	8	2	06160822R0
8	32	80	8	2	06160832R0
8	42	90	8	2	06160842R0
10	32	80	10	2	06161032R0
10	42	90	10	2	06161042R0
10	52	100	10	2	06161052R0
12	32	80	12	2	06161232R0
12	42	90	12	2	06161242R0
12	52	100	12	2	06161252R0
14	32	100	14	2	06161432R0
14	52	110	14	2	06161452R0
16	42	100	16	2	06161642R0
16	52	110	16	2	06161652R0
16	72	130	16	2	06161672R0
18	72	140	18	2	06161872R0
20	72	140	20	2	06162072R0



Down - cut solid carbide spiral bit.



Fresa helicoidal negativa de metal duro macizo.



Fraise hélicoidale négative en carbure massif.



Hartmetall - massive - Oberfräser mit negativen Spiralschneiden.

# 618 Fresa elicoidale negativa in metallo duro integrale

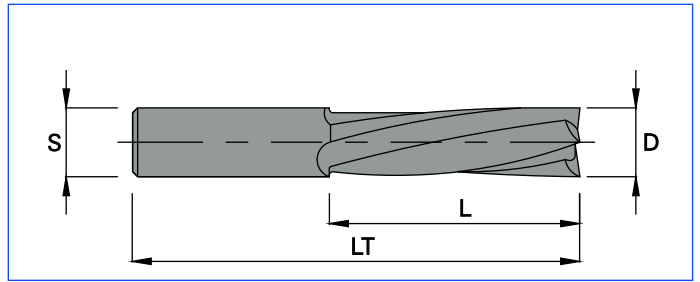

**HW**

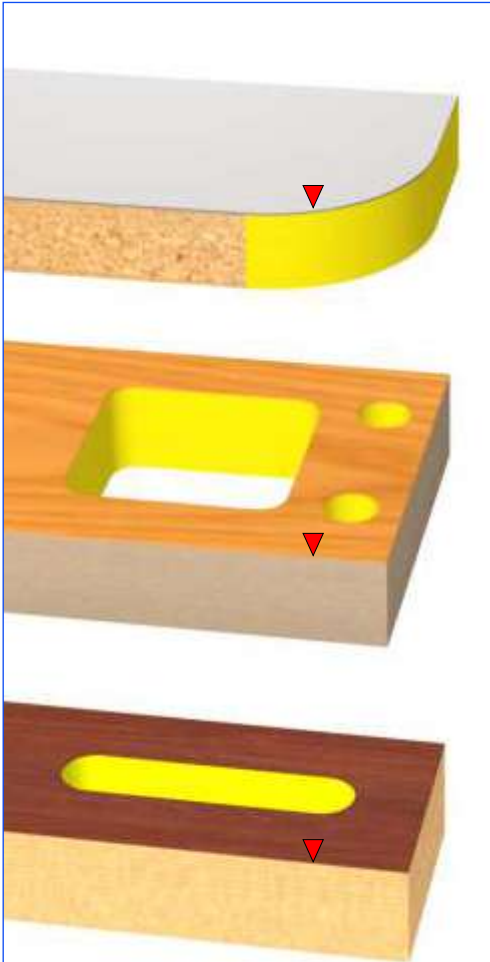

▲ = finitura migliore.

 Better finish.

 Finissage meilleur.

 Acabado mejor.

 Feinbearbeitung.

D	L	LT	S	Z	COD. RH
8	22	70	8	3	06180822R0
8	32	80	8	3	06180832R0
10	32	80	10	3	06181032R0
10	42	90	10	3	06181042R0
12	32	80	12	3	06181232R0
12	42	90	12	3	06181242R0
12	52	100	12	3	06181252R0
14	42	90	14	3	06181442R0
14	52	100	14	3	06181452R0
16	42	100	16	3	06181642R0
16	52	110	16	3	06181652R0
16	72	130	16	3	06181672R0
18	52	120	18	3	06181852R0
18	72	140	18	3	06181872R0
18	102	170	18	3	06181810R0
20	52	120	20	3	06182052R0
20	72	140	20	3	06182072R0
20	102	170	20	3	06182010R0

 Down - cut solid carbide spiral bit.

 Fraise hélicoidale négative en carbure massif.

 Fresa helicoidal negativa de metal duro macizo.

 Hartmetall - massive - Oberfräser mit negativen Spiralschneiden.

# 620 Fresa elicoidale negativa in metallo duro integrale con rompitruciolo

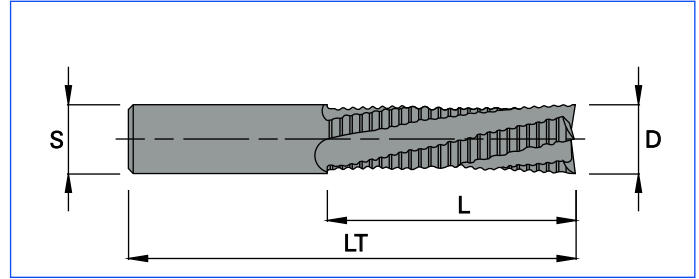

**HW**

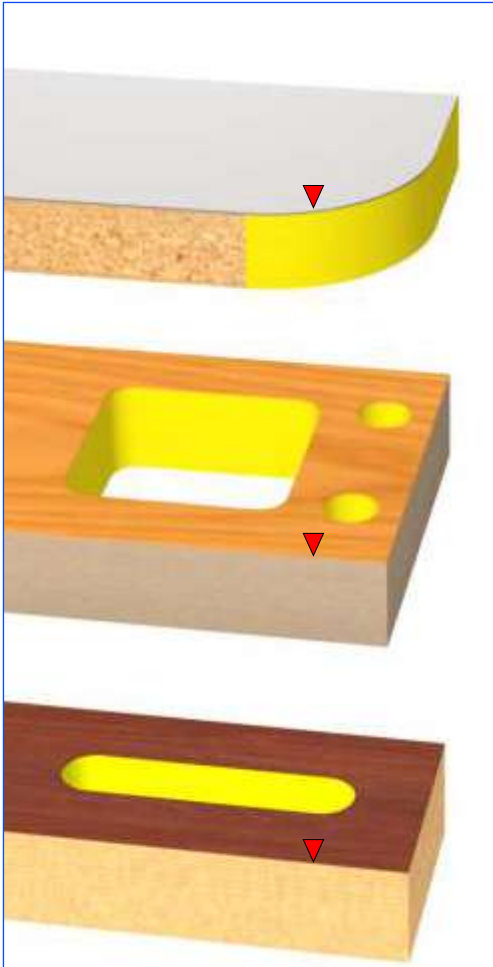

▲ = finitura migliore.



Better finish.



Finissage meilleur.



Acabado mejor.



Feinbearbeitung.

D	L	LT	S	Z	COD. RH
8	22	70	8	3	06200822R0
8	32	80	8	3	06200832R0
10	32	80	10	3	06201032R0
10	42	90	10	3	06201042R0
12	32	80	12	3	06201232R0
12	42	90	12	3	06201242R0
12	52	100	12	3	06201252R0
14	42	90	14	3	06201442R0
14	52	100	14	3	06201452R0
16	42	100	16	3	06201642R0
16	52	110	16	3	06201652R0
16	72	130	16	3	06201672R0
18	52	120	18	3	06201852R0
18	72	140	18	3	06201872R0
18	102	170	18	3	06201810R0
20	52	120	20	3	06202052R0
20	72	140	20	3	06202072R0
20	102	170	20	3	06202010R0



Down - cut solid carbide spiral bit with chip - breaker.



Fresa helicoidal negativa de metal duro macizo con rompevirutas.



Fraise hélicoidale négative en carbure massif avec brise - copeaux.



Hartmetall - massive - Oberfräser mit negativen Spiralschneiden und mit Spanbrechern.

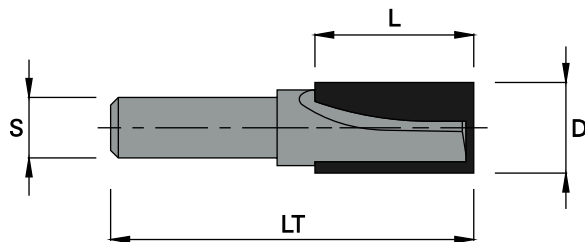

HW

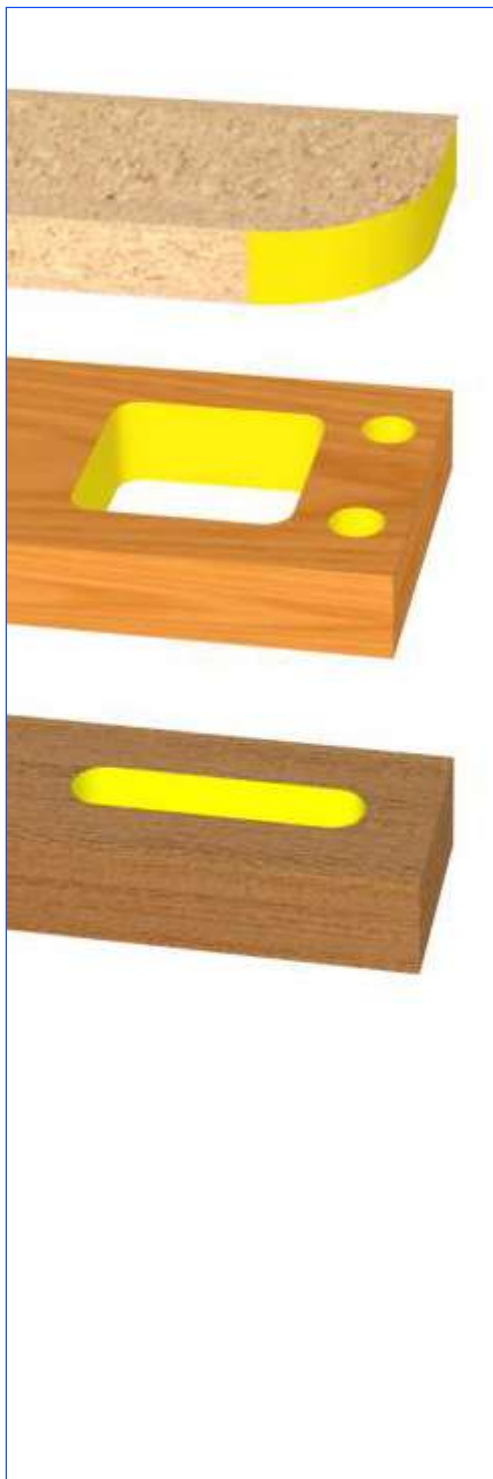

D	L	LT	S	Z	COD. RH
4	10	37	9.5x20	2	0516040000
5	12	39	9.5x20	2	0516050000
6	14	41	9.5x20	2	0516060000
7	16	43	9.5x20	2	0516070000
8	18	48	9.5x20	2	0516080000
9	20	52	9.5x20	2	0516090000
10	22	52	9.5x20	2	0516100000
11	24	52	9.5x20	2	0516110000
12	26	52	12x20	2	0516120000
14	28	56	12x20	2	0516140000
15	30	60	12x20	2	0516150000
16	32	60	12x20	2	0516160000
18	35	64	12x20	2	0516180000
20	38	68	12x20	2	0516200000

 Router cutter.

 Fresa para fresadora.

 Fraise pour defonçeuse.

 Oberfräser.



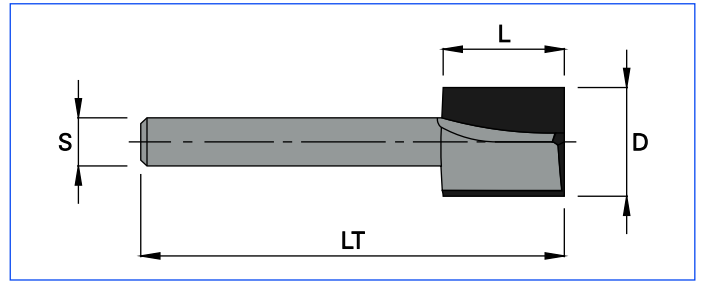
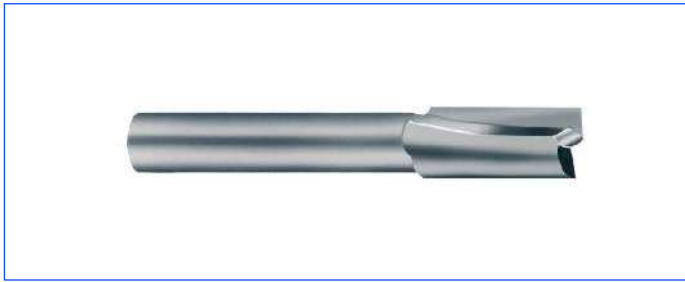

**HW**

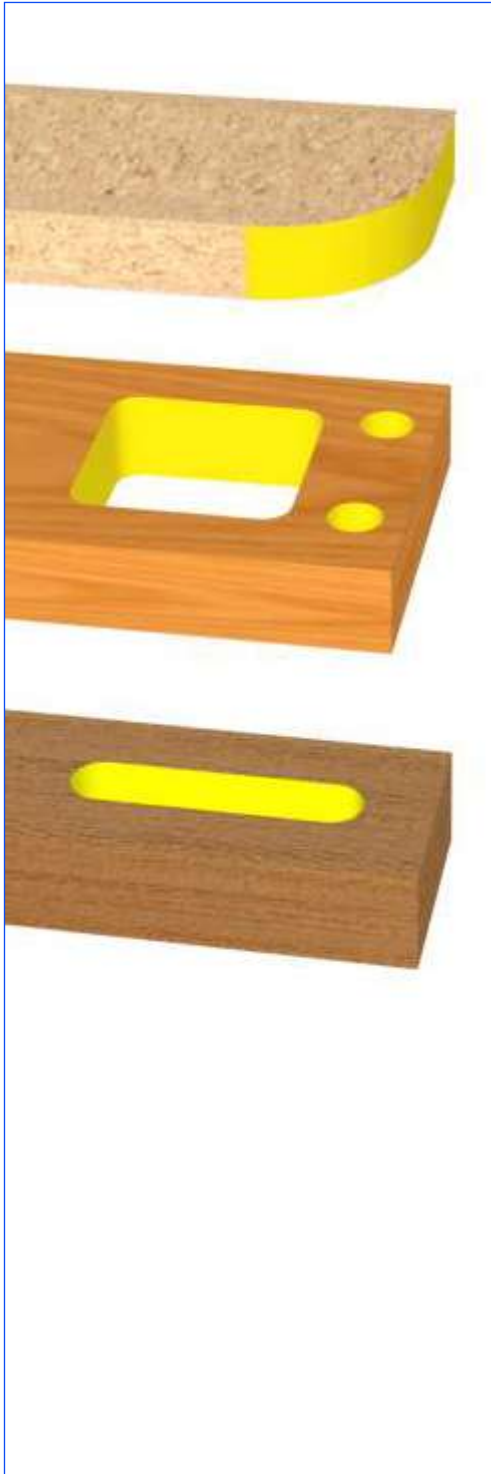

D	L	LT	S	Z	COD. RH
4	10	55	8	2	0515040000
5	12	55	8	2	0515050000
6	14	55	8	2	0515060000
7	17	55	8	2	0515070000
8	20	55	8	2	0515080000
10	20	60	8	2	0515100000
12	20	60	8	2	0515120000
14	20	60	8	2	0515140000
15	20	60	8	2	0515150000
16	20	70	8	2	0515160000
18	20	70	8	2	0515180000
20	20	70	8	2	0515200000
22	10	70	8	2	0515220000
24	10	70	8	2	0515240000

 Router cutter.

 Fresa para fresadora.

 Fraise pour defonceuse.

 Oberfräser.

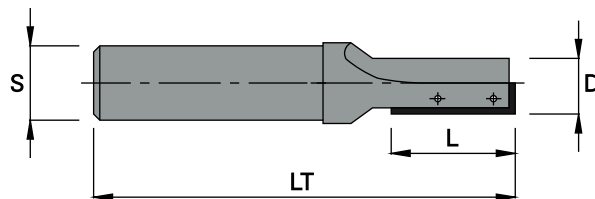

HW

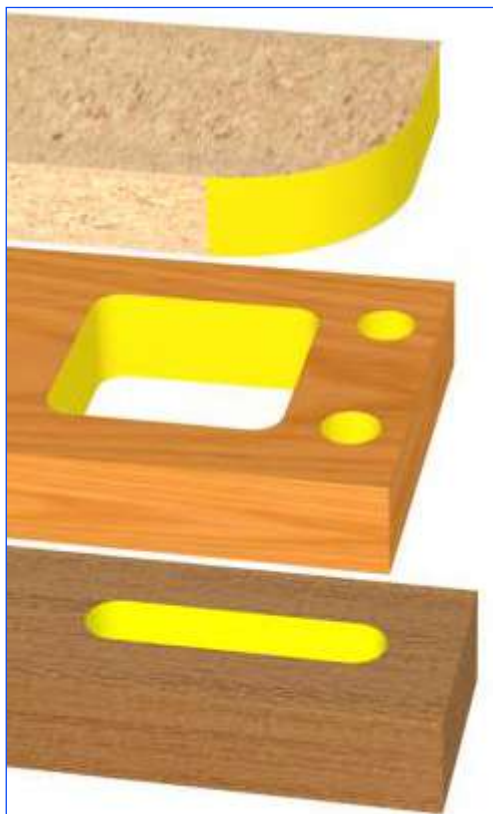

D	L	LT	S	Z	COD. RH
8	20	63	8x30	1	0517080830
8	20	68	12x35	1	0517081235
8	20	68	12.7x35	1	0517081335
10	20	63	8x30	1	0517100830
10	20	68	12x35	1	0517101235
10	20	68	12.7x35	1	0517101335
12	20	63	8x30	1	0517120830
12	20	68	12x35	1	0517121235
12	20	68	12.7x35	1	0517121335
12,7	30	74	12.7x35	1	0517131335
14	30	74	12x35	1	0517141235
14	30	74	12.7x35	1	0517141335
15	30	74	12x35	1	0517151235
15	30	74	12.7x35	1	0517151335
16	30	74	12x35	1	0517161235
16	30	74	12.7x35	1	0517161335
18	30	74	12x35	1	0517181235
18	30	74	12.7x35	1	0517181335
20	30	74	12x35	1	0517201235
20	30	74	12.7x35	1	0517201335

## Ricambi / Spare parts / Rechanges / Repuestos / Ersatzteile

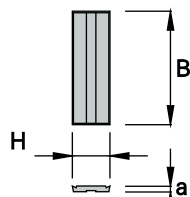

D	B	H	a	COD.
8÷12	20	5.5	1.1	0517A00000
12.7	30	6.5	1.1	0517B00000
14÷20	30	10	1.5	0517C00000

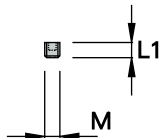

D	M x L1	COD.
8÷12.7	M2.5 x 2.5	048070P202
14÷20	M4 x 4	048070P404

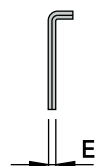

D	E	COD.
8÷12.7	1.3	048078Z013
14÷20	2	048078Z020

 Router cutter with turnover knives.

 Fresa para fresadora con cuchillas reversibles.

 Outil pour defonceuse à plaquettes réversibles.

 Wendemesser - Oberfraeser.

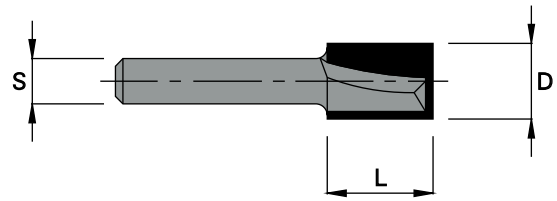

HW

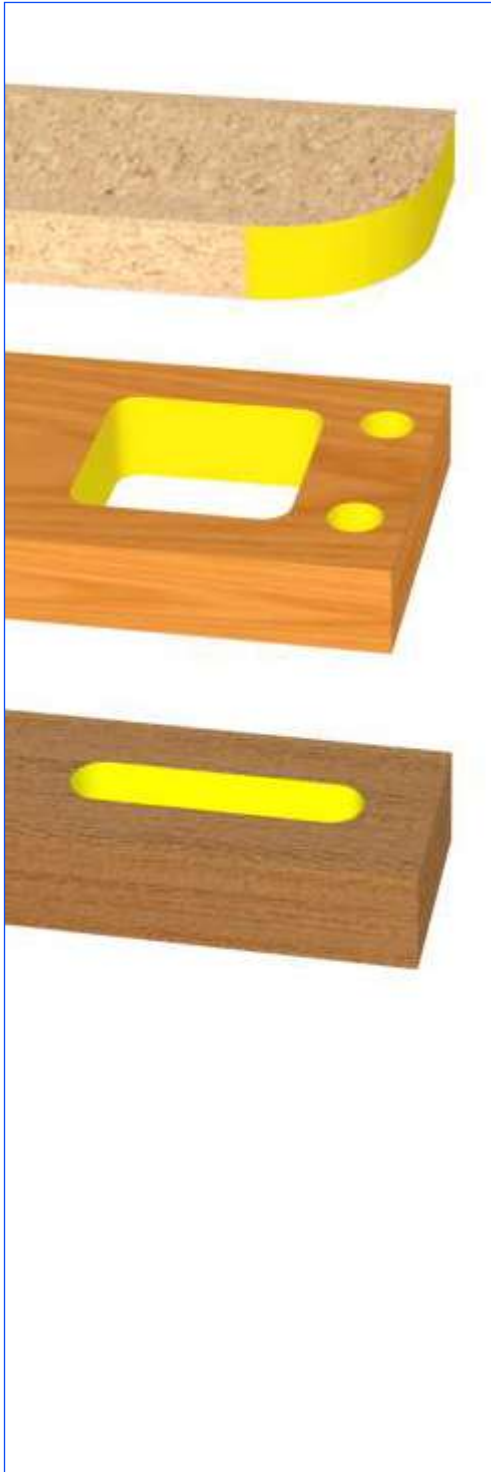

D	L	S	Z	COD.
4	11	6	2	0581040000
5	11	6	2	0581050000
6	19	6	2	0581060000
7	19	6	2	0581070000
8	19	6	2	0581080000
9	19	6	2	0581090000
10	19	6	2	0581100000
12	19	6	2	0581120000
14	19	6	2	0581140000
15	19	6	2	0581150000
16	19	6	2	0581160000
18	19	6	2	0581180000
20	19	6	2	0581200000
22	19	6	2	0581220000

 Cutter for portable routers.

 Fresa para maquinas portatiles.

 Fraise pour défonceuses portatives.

 Fräser für Handoberfräsen.

# 582 - A

## Fresa per elettrofresatrici

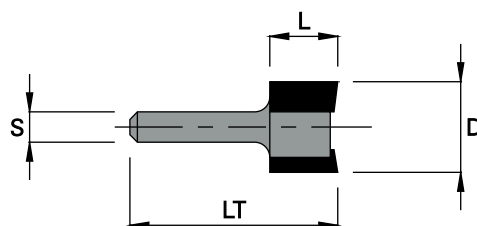

HW

D	L	LT	S	Z	COD.
20	19	51	6	2	0582A00000

# 582 - B

## Fresa per elettrofresatrici

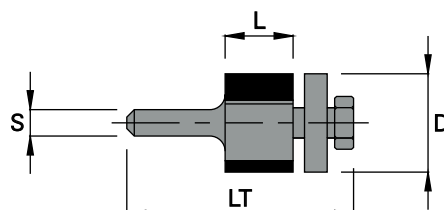

HW

D	L	LT	S	Z	COD.
19	16	60	6	2	0582B00000

# 582 - C

## Fresa per elettrofresatrici

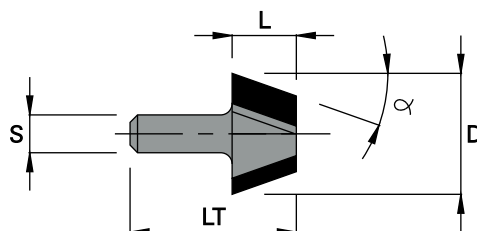

HW

$\alpha$	D	L	LT	S	Z	COD.
23°	22.2	10	38	6	2	0582C23000
30°	25.4	10	38	6	2	0582C30000
45°	35	10	38	6	2	0582C45000

 Cutter for portable routers.

 Fresa para máquinas portátiles.

 Fraiser pour défonceuses portatives.

 Fräser für Handoberfräsen.

# 582 - D

## Fresa per elettrofresatrici

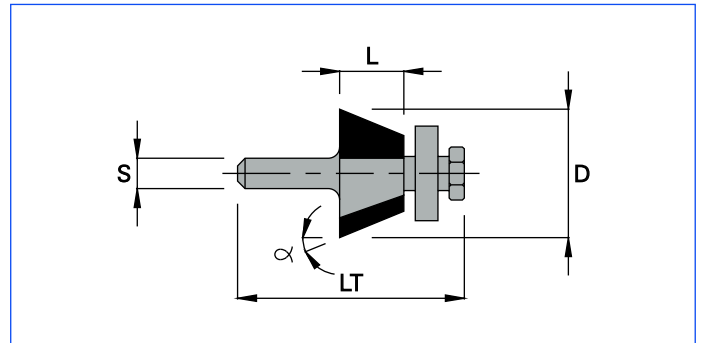

HW

$\alpha$	D	L	LT	S	Z	COD.
15°	13	12.7	46	6	2	0582D15000
25°	19	12.7	46	6	2	0582D25000
45°	31.7	13	51	6	2	0582D45000

# 582 - E

## Fresa per elettrofresatrici

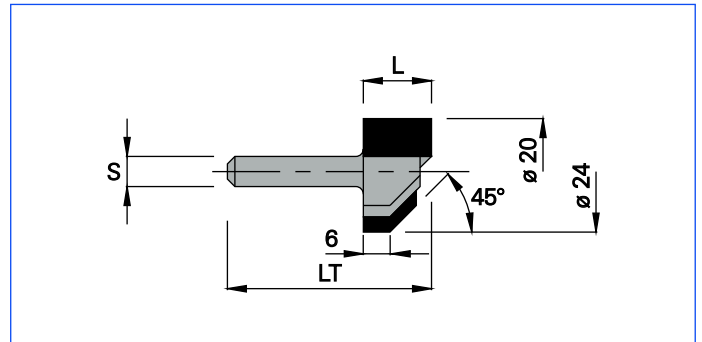

HW

L	LT	S	Z	COD.
15	44	6	2	0582E00000

# 582 - F

## Fresa per elettrofresatrici

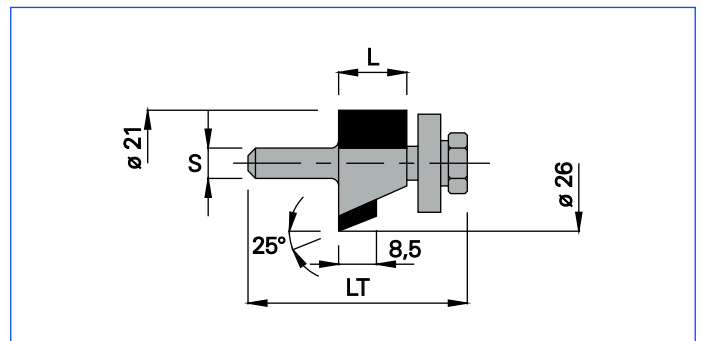

HW

L	LT	S	Z	COD.
15	49	6	2	0582F00000

 Cutter for portable routers.

 Fresa para máquinas portátiles.

 Fraiser pour défonceuses portatives.

 Fräser für Handoberfräsen.

538

## Fresa per scolpitrice a fondo tondo

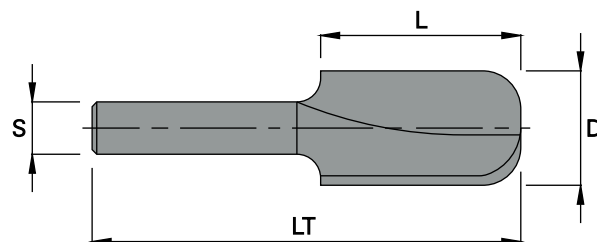

HS

D	L	LT	S	Z	COD. RH	COD. LH
6	25	90	11x45	1	05380600R0	05380600L0
8	35	90	11x45	1	05380800R0	05380800L0
10	38	90	11x45	2	05381000R0	05381000L0
12	42	90	11x45	2	05381200R0	05381200L0
14	42	90	11x45	2	05381400R0	05381400L0
16	42	90	11x45	2	05381600R0	05381600L0
20	42	90	11x45	2	05382000R0	05382000L0
24	42	90	11x45	2	05382400R0	05382400L0

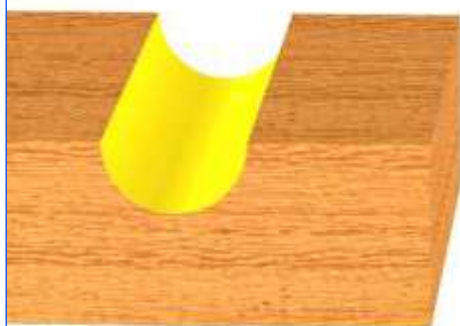

540

## Fresa per scolpitrice a fondo piano

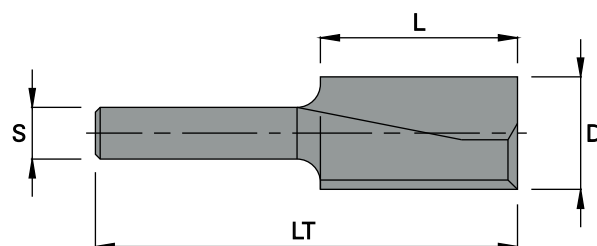

HS

D	L	LT	S	Z	COD. RH	COD. LH
6	25	90	11x45	1	05400600R0	05400600L0
8	35	90	11x45	1	05400800R0	05400800L0
10	38	90	11x45	2	05401000R0	05401000L0
12	42	90	11x45	2	05401200R0	05401200L0
14	42	90	11x45	2	05401400R0	05401400L0
16	42	90	11x45	2	05401600R0	05401600L0
20	42	90	11x45	2	05402000R0	05402000L0
24	42	90	11x45	2	05402400R0	05402400L0

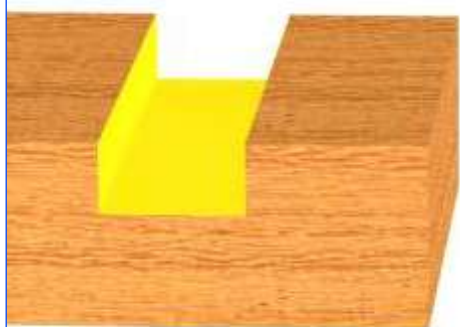

Carving bit.

Broca para copiadora de talla.

Mèche à sculpter.

Schnitzfräser.

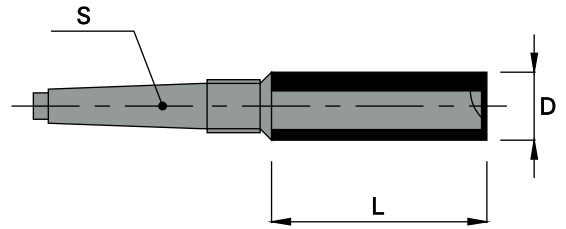

HW

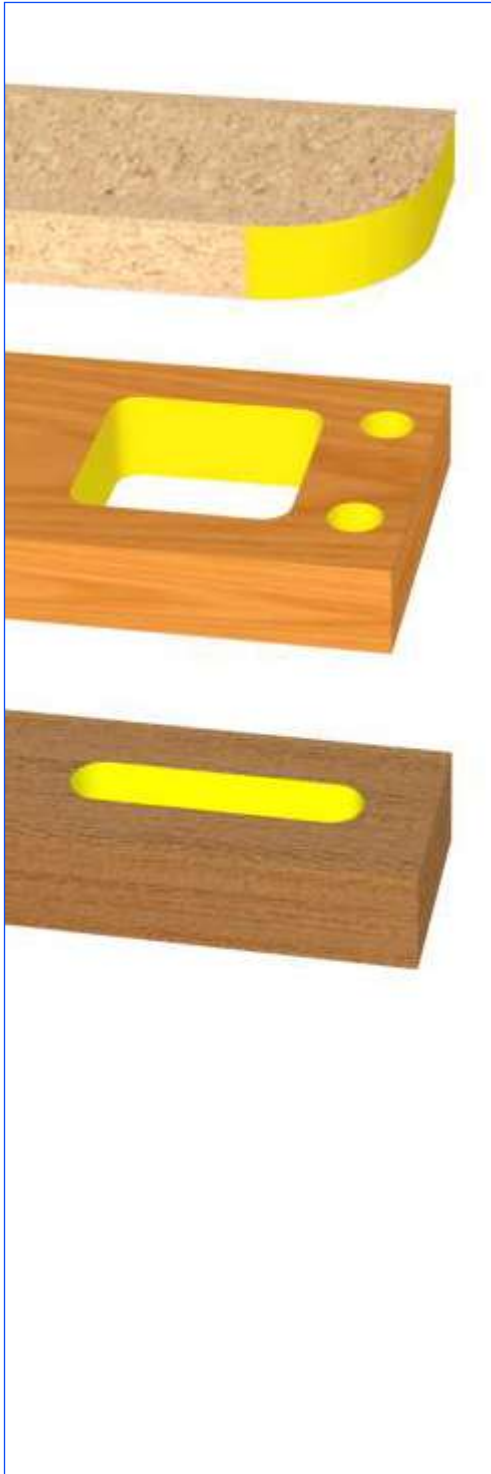

D	L	S	Z	COD. RH
16	40	MK2 Ø20x14 Filx1"	2	0518164020
16	50	MK2 Ø20x14 Filx1"	2	0518165020
18	40	MK2 Ø20x14 Filx1"	2	0518184020
18	50	MK2 Ø20x14 Filx1"	2	0518185020
18	60	MK2 Ø20x14 Filx1"	2	0518186020
20	40	MK2 Ø20x14 Filx1"	2	0518204020
20	50	MK2 Ø20x14 Filx1"	2	0518205020
20	60	MK2 Ø20x14 Filx1"	2	0518206020
16	40	MK2 M30x1.5	2	0518164030
16	50	MK2 M30x1.5	2	0518165030
18	40	MK2 M30x1.5	2	0518184030
18	50	MK2 M30x1.5	2	0518185030
18	60	MK2 M30x1.5	2	0518186030
20	40	MK2 M30x1.5	2	0518204030
20	50	MK2 M30x1.5	2	0518205030
20	60	MK2 M30x1.5	2	0518206030



Router cutter.



Fresa para fresadora.



Fraise pour defonçeuse.



Oberfräser.

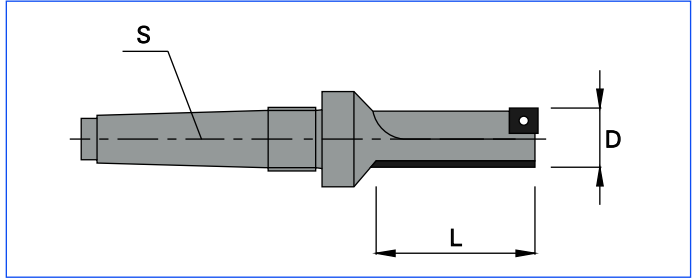

## HW

D	L	S	Z	COD. RH
16	50	MK2 Ø20x14 Filx1"	1 + 1	0519165020
18	50	MK2 Ø20x14 Filx1"	1 + 1	0519185020
20	50	MK2 Ø20x14 Filx1"	1 + 1	0519205020
22	50	MK2 Ø20x14 Filx1"	1 + 1	0519225020
16	50	MK2 M30x1.5	1 + 1	0519165030
18	50	MK2 M30x1.5	1 + 1	0519185030
20	50	MK2 M30x1.5	1 + 1	0519205030
22	50	MK2 M30x1.5	1 + 1	0519225030

### Ricambi / Spare parts / Rechanges / Repuestos / Ersatzteile

	D	B	H	a	COD.
	16	8.2	11	1.5	0519A00000
	18	9.2	11	1.5	0519B00000
	20	10.2	11	1.5	0519C00000
	22	11.2	11.2	1.5	0519D00000
	D	B	H	a	COD.
	16÷22	50	12	1.5	0480050050
	D	B	H	a	COD.
	16÷22	48.4	9.5	3.4	0519R00000
	D	M x B			COD.
	16÷18	3.5 x 7			0480730407
	20÷22	3.5 x 9			0480730409
	D	M x B			COD.
	16÷22	3.5 x 9			0480730409
	D				COD.
	16÷22	TORX T15			048076T150

Router cutter with turnover knives.

Fresa para fresadora con cuchillas reversibles.

Outil pour defonceuse à plaquettes réversibles.

Wendemesser - Oberfraeser.



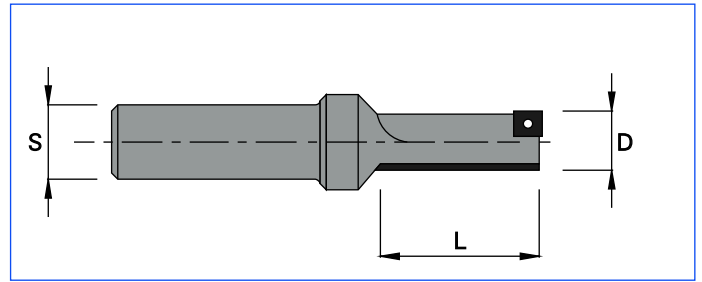



## HW

D	L	S	Z	COD. RH
16	50	20x50	1 + 1	0520A16502
18	50	20x50	1 + 1	0520A18502
20	50	20x50	1 + 1	0520A20502
22	50	20x50	1 + 1	0520A22502

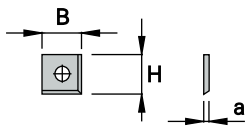
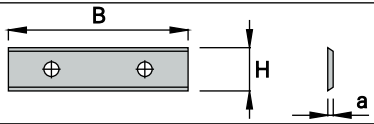
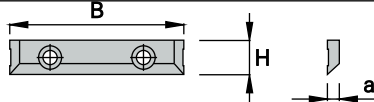
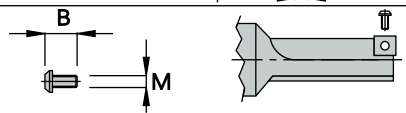
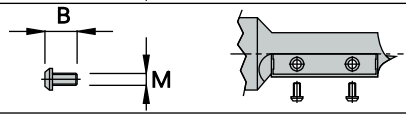
### Ricambi / Spare parts / Rechanges / Repuestos / Ersatzteile

	D	B	H	a	COD.
	16	8.2	11	1.5	0519A00000
	18	9.2	11	1.5	0519B00000
	20	10.2	11	1.5	0519C00000
	22	11.2	11.2	1.5	0519D00000
	D	B	H	a	COD.
	16÷22	50	12	1.5	0480050050
	D	B	H	a	COD.
	16÷22	48.4	9.5	3.4	0519R00000
	D	M x B			COD.
	16÷18	3.5 x 7			0480730407
	20÷22	3.5 x 9			0480730409
	D	M x B			COD.
	16÷22	3.5 x 9			0480730409
	D				COD.
	16÷22	TORX T15			048076T150



Router cutter with turnover knives.



Fresa para fresadora con cuchillas reversibles.



Outil pour defonceuse à plaquettes réversibles.



Wendemesser - Oberfraeser.

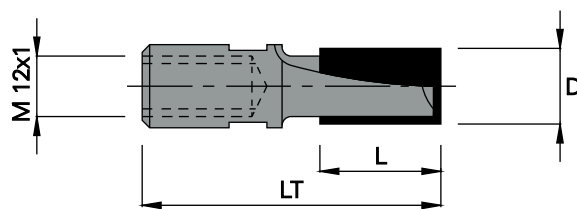

HW

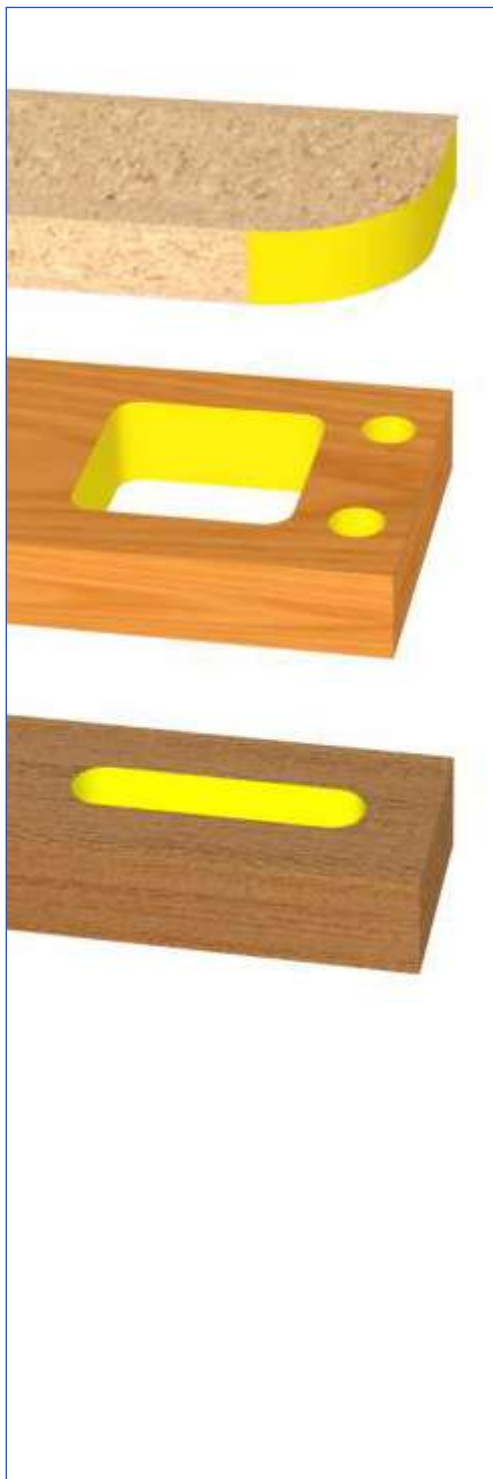

D	L	LT	Z	MAT.	COD. RH
6	18	60	2	HW	05770600HW
8	23	60	2	HW	05770800HW
10	23	60	2	HW	05771000HW
12	23	60	2	HW	05771200HW
14	23	60	2	HW	05771400HW
15	25	60	2	HW	05771500HW
16	25	60	2	HW	05771600HW
18	25	60	2	HW	05771800HW
20	25	60	2	HW	05772000HW
22	25	60	2	HW	05772200HW
24	25	60	2	HW	05772400HW

 Cutter for portable routers.

 Fresa para maquinas portatiles.

 Fraise pour défonceuses portatives.

 Fräser für Handoberfräsen.

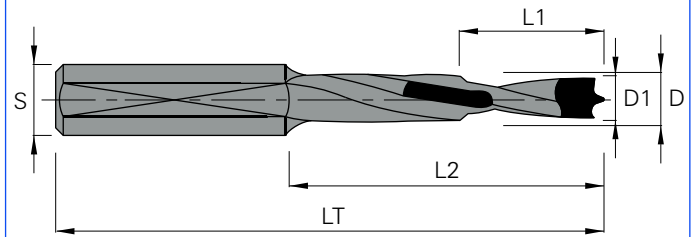

HW

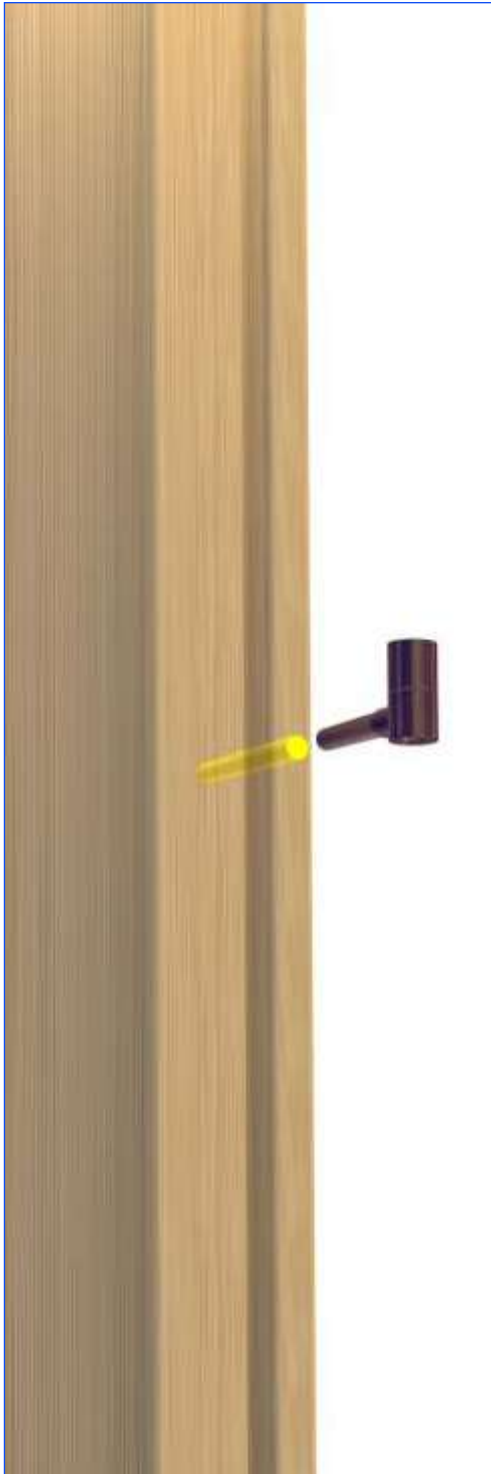

D1	D	L1	L2	LT	S	ANUBA	Z	COD.RH
3.8	5.25	20	40	70	10	9	2	06500970R0
4.2	5.75	20	40	70	10	11	2	06501170R0
5.2	6.75	15	40	70	10	13	2	06501370R0
5.5	7.25	15	40	70	10	14	2	06501470R0
6	7.75	15	40	70	10	16	2	06501670R0
6.6	8.2	20	40	70	10	18	2	06501870R0
7.2	8.7	20	40	70	10	20	2	06502070R0
3.8	5.25	20	60	90	10	9	2	06500990R0
4.2	5.75	20	60	90	10	11	2	06501190R0
5.2	6.75	15	60	90	10	13	2	06501390R0
5.5	7.25	15	60	90	10	14	2	06501490R0
6	7.75	15	60	90	10	16	2	06501690R0
6.6	8.2	20	60	90	10	18	2	06501890R0
7.2	8.7	20	60	90	10	20	2	06502090R0



Dowel drill for hinges.



Broca para bisagras.



Mèche pour charnières.



Dübelbohrer für Gelenke.

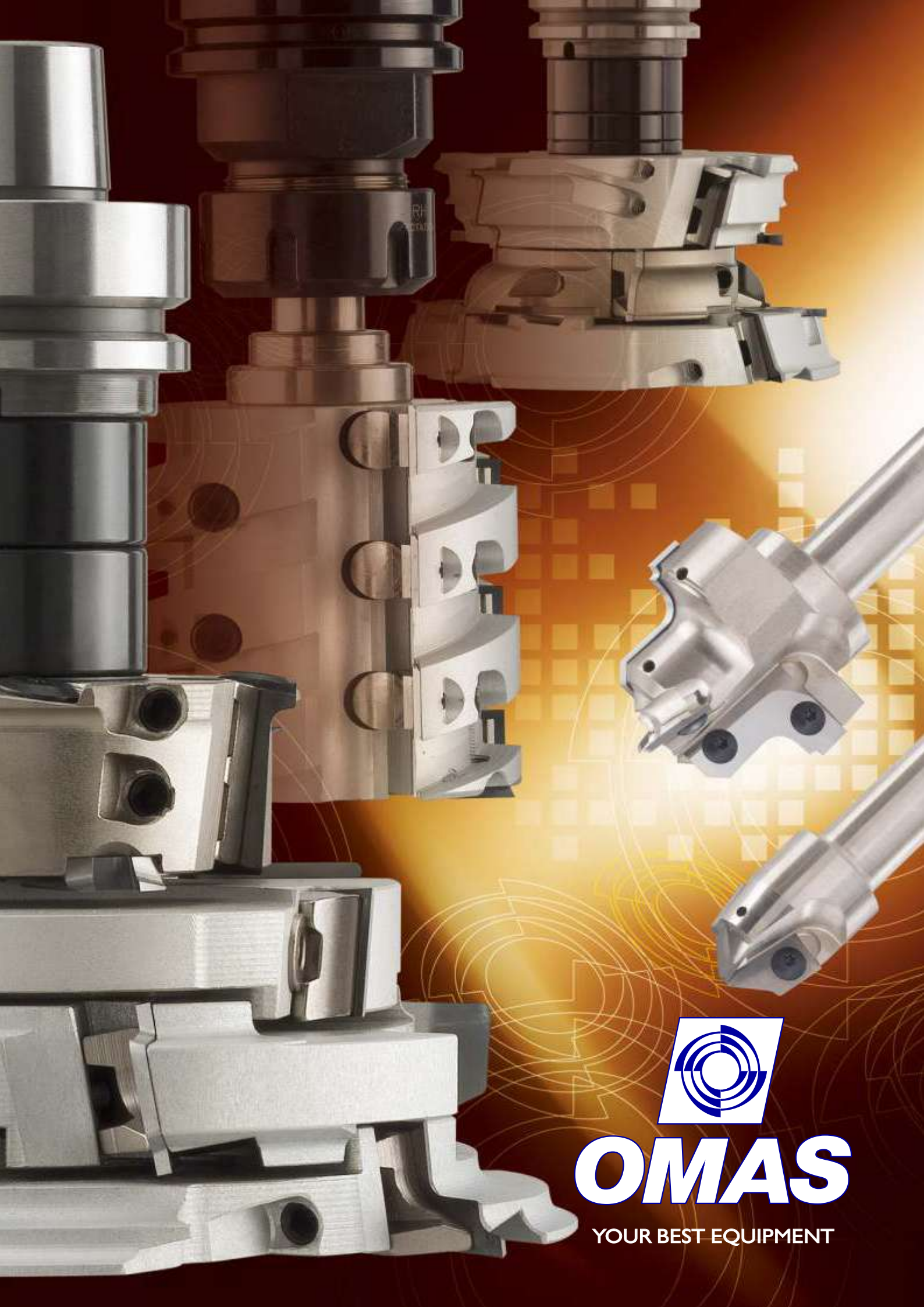

**OMAS**

YOUR BEST EQUIPMENT

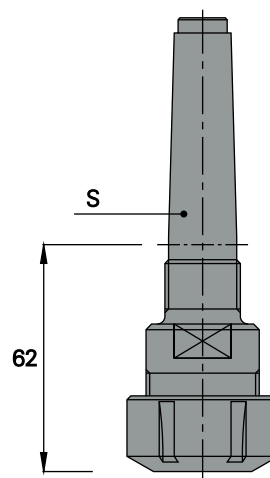

S

COD. RH

MK2 ø 20x14 Fil x 1"

0526AMK220

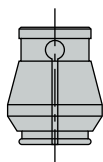

Vedere art. 527 - 20 / See art. 527 - 20

### Ricambi / Spare parts / Rechanges / Repuestos / Ersatzteile

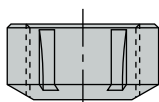

COD. RH

0527GH20R0

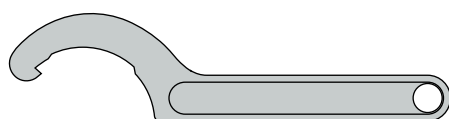

COD.

0303A40420

 Centric chuck.

 Mandril concéntrico.

 Mandrin centré.

 Zentrisches Spannfutter.

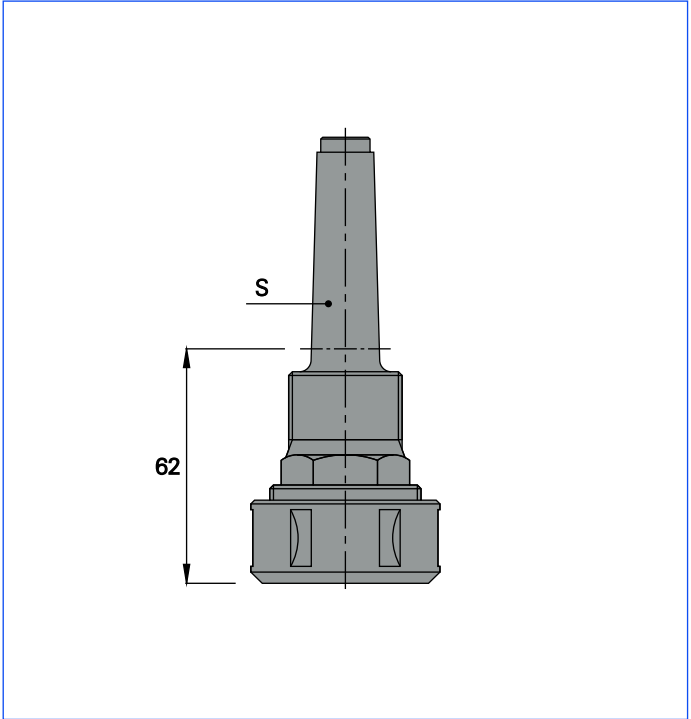

S	COD. RH	COD. LH
MK2 M30x1.5	0526BMK2R0	0526BMK2L0
MK3 M30x1.5	0526BMK3R0	

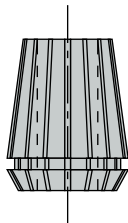

Vedere art. 527 - 32 / See art. 527 - 32

### Ricambi / Spare parts / Rechanges / Repuestos / Ersatzteile

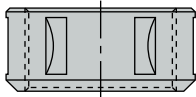

COD. RH	COD. LH
0527GH32R0	0527GH32L0

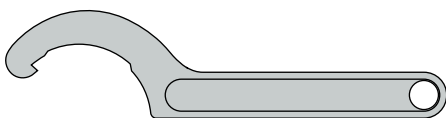

COD.
0303A52550

 Centric chuck.

 Mandril concéntrico.

 Mandrin centré.

 Zentrisches Spannfutter.

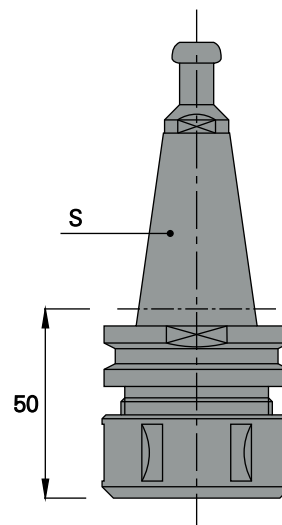

MACCHINA / MACHINE

S

COD. RH

COD. LH

BIESSE - MASTERWOOD  
CMS - BULLERI - BUSELLATO  
ALBERTI

ISO 30  
ISO 30  
ISO 30

0526CBIER0  
0526CCMSR0  
0526CALBR0

0526CBIELO  
0526CCMSLO  
0526CALBLO

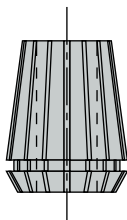

Vedere art. 527 - 32 / See art. 527 - 32

Ricambi / Spare parts / Rechanges / Repuestos / Ersatzteile

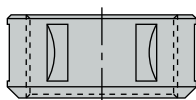

COD. RH

COD. LH

0527GH32R0

0527GH32L0

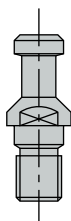

MACCHINA / MACHINE

COD.

BIESSE - MASTERWOOD  
CMS - BULLERI - BUSELLATO  
ALBERTI

0527TIBIE0  
0527TICMS0  
0527TIALB0

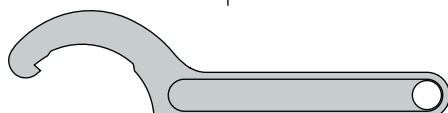

COD.

0303A52550



Centric chuck.



Mandril concéntrico.



Mandrin centré.



Zentrisches Spannfutter.

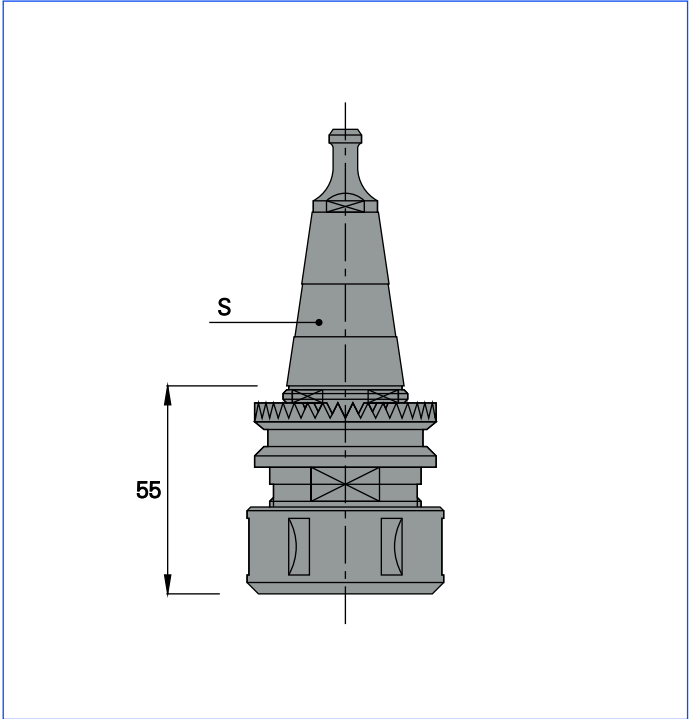

MACCHINA / MACHINE	S	COD. RH	COD. LH
MORBIDELLI - SCM	ISO 30	0526DSCMR0	0526DSCML0

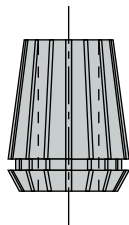

Vedere art. 527 - 32 / See art. 527 - 32

**Ricambi / Spare parts / Rechanges / Repuestos / Ersatzteile**

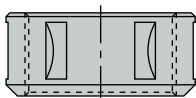

COD. RH	COD. LH
0527GH32R0	0527GH32L0

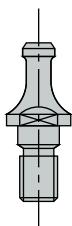

COD.
0527TISCM0

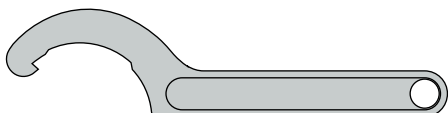

COD.
0303A52550

 Centric chuck.

 Mandril concéntrico.

 Mandrin centré.

 Zentrisches Spannfutter.



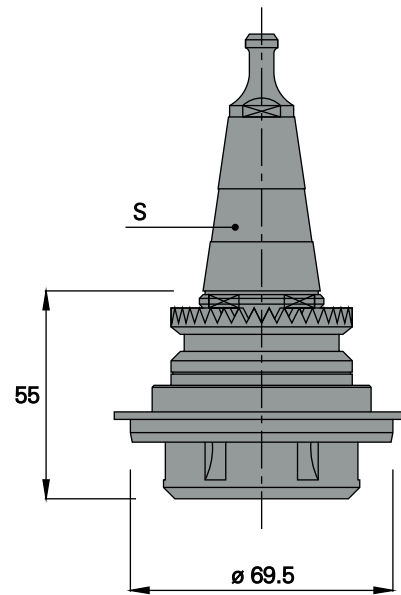

MACCHINA / MACHINE

S

COD. RH

COD. LH

MORBIDELLI - SCM

ISO 30

0526ESCMR0

0526ESCML0

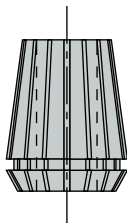

Vedere art. 527 - 32 / See art. 527 - 32

Ricambi / Spare parts / Rechanges / Repuestos / Ersatzteile

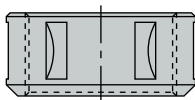

COD. RH

COD. LH

0527GH32R0

0527GH32L0

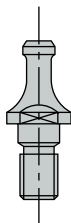

COD.

0527TISCM0

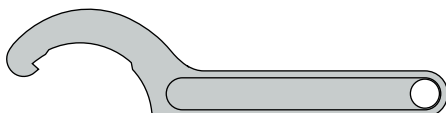

COD.

0303A52550



Centric chuck.



Mandril concéntrico.



Mandrin centré.



Zentrisches Spannfutter.

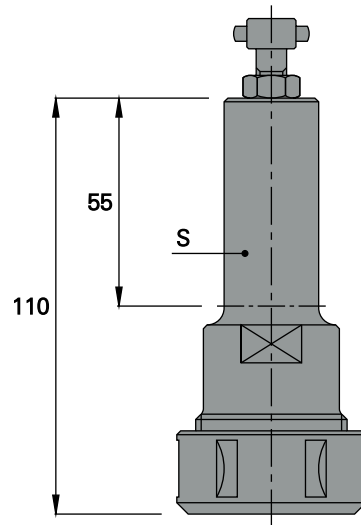

S

COD. RH

∅ 25 x 55

0526FLEURO

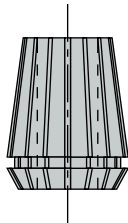

Vedere art. 527 - 32 / See art. 527 - 32

**Ricambi / Spare parts / Rechanges / Repuestos / Ersatzteile**

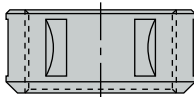

COD. RH

0527GH32R0

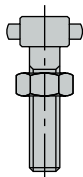

COD.

0527TILEU0

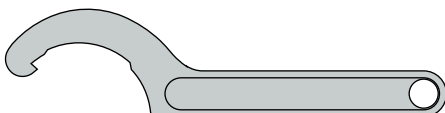

COD.

0303A52550

 Centric chuck.

 Mandril concéntrico.

 Mandrin centré.

 Zentrisches Spannfutter.

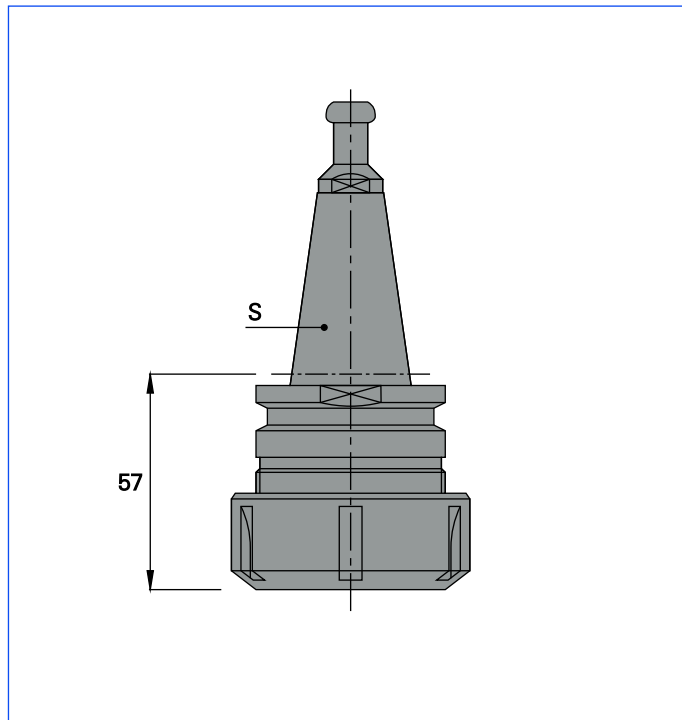

MACCHINA / MACHINE	S	COD. RH
BIESSE	ISO 30	0526HBIER0
CMS - BULLERI	ISO 30	0526HCMSR0
ALBERTI - MASTERWOOD	ISO 30	0526HALBR0

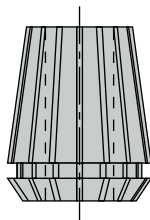

Vedere art. 527 - 40 / See art. 527 - 40

### Ricambi / Spare parts / Rechanges / Repuestos / Ersatzteile

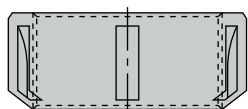

COD. RH

0527GH40R0

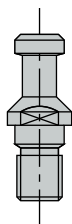

MACCHINA / MACHINE

COD.

BIESSE	0527TIBIE0
CMS - BULLERI	0527TICMS0
ALBERTI - MASTERWOOD	0527TIALB0

COD.

0303A62650

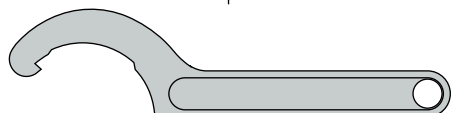

 Centric chuck.

 Mandril concéntrico.

 Mandrin centré.

 Zentrisches Spannfutter.

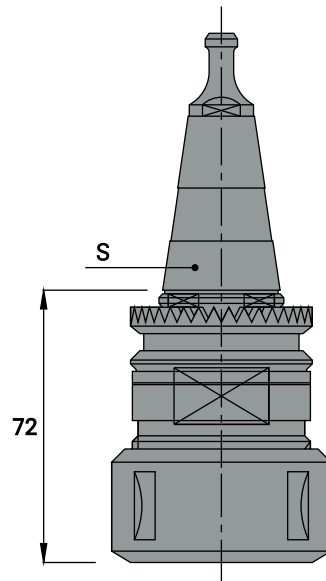

MACCHINA / MACHINE

S

COD. RH

MORBIDELLI - SCM

ISO 30

0526LSCMR0

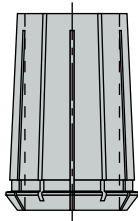

Vedere art. 527 - 25 / See art. 527 - 25

Ricambi / Spare parts / Rechanges / Repuestos / Ersatzteile

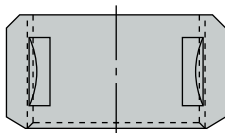

COD. RH

0527GH45R0

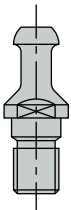

COD.

0527TISCM0

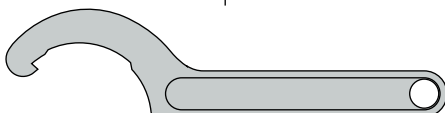

COD.

0303A62650

 Centric chuck.

 Mandril concéntrico.

 Mandrin centré.

 Zentrisches Spannfutter.

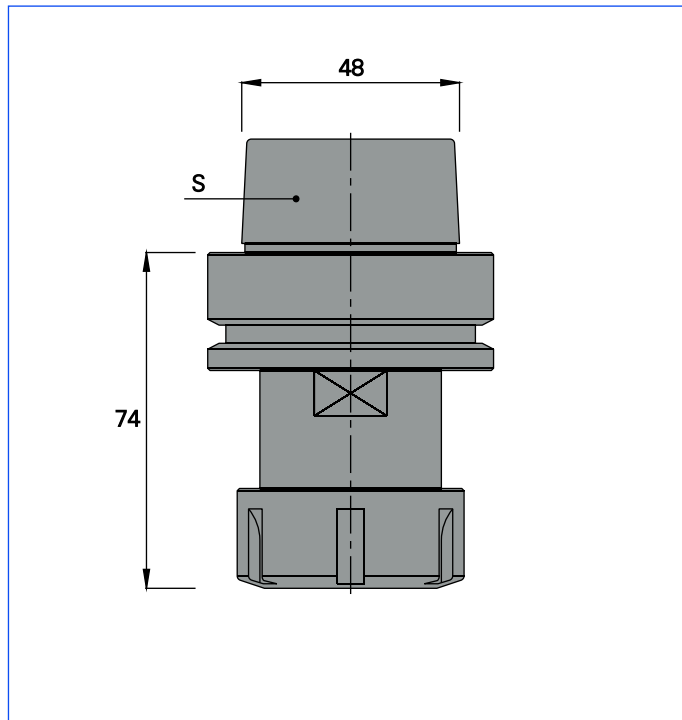

S	COD. RH
HSK63E	0526K63E32

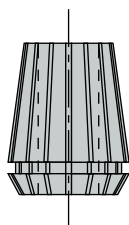

Vedere art. 527 - 32 / See art. 527 - 32

Ricambi / Spare parts / Rechanges / Repuestos / Ersatzteile

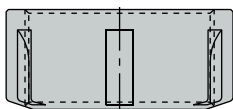

COD. RH
0527GH32R0

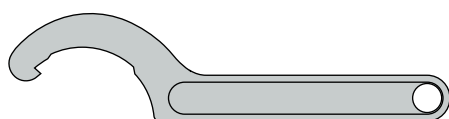

COD.
0303A52550

 Centric chuck HSK63E.

 Mandril concéntrico HSK63E.

 Mandrin centré HSK63E.

 Zentrisches Spannfutter HSK63E.

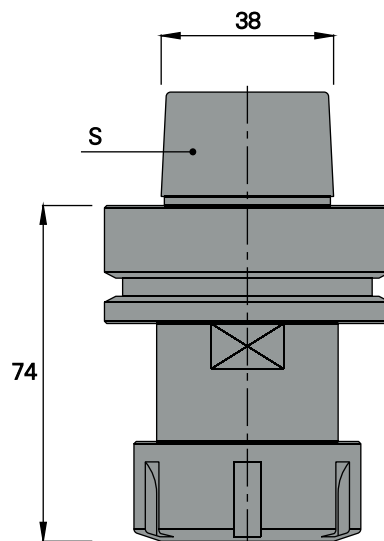

S

COD. RH

COD. LH

HSK63F

0526K63F32

0526K63F3L

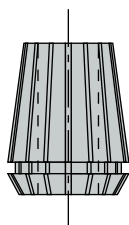

Vedere art. 527 - 32 / See art. 527 - 32

### Ricambi / Spare parts / Rechanges / Repuestos / Ersatzteile

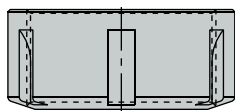

COD. RH

COD. LH

0527GH32R0

0527GH32L0

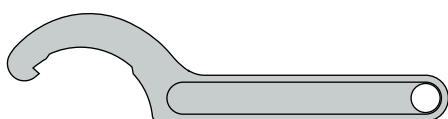

COD.

0303A52550

 Centric chuck HSK63F.

 Mandrin centré HSK63F.

 Mandril concéntrico HSK63F.

 Zentrisches Spannfutter HSK63F.

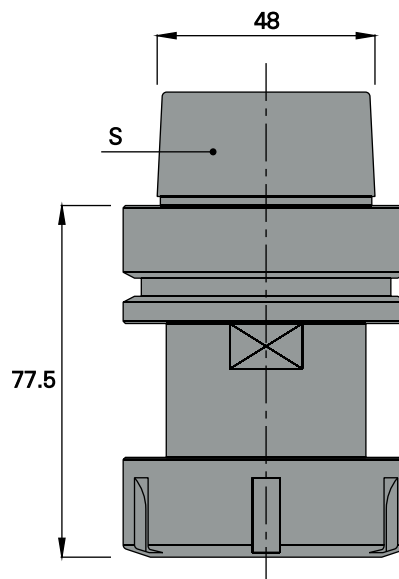

S

COD. RH

HSK63E

0526K63E40

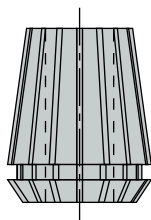

Vedere art. 527 - 40 / See art. 527 - 40

## Ricambi / Spare parts / Rechanges / Repuestos / Ersatzteile

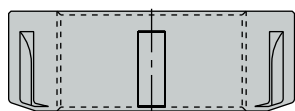

COD. RH

0527GH40R0

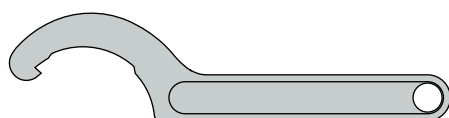

COD.

0303A62650

 Centric chuck HSK63E.

 Mandril concéntrico HSK63E.

 Mandrin centré HSK63E.

 Zentrisches Spannfutter HSK63E.

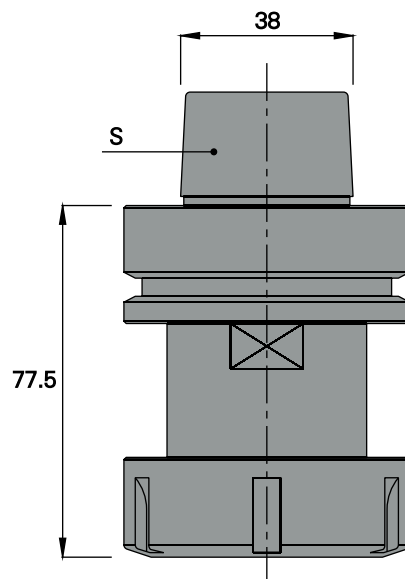

S

COD. RH

COD. LH

HSK63F

0526K63F40

0526K63F4L

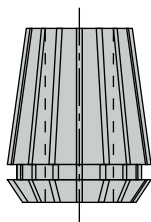

Vedere art. 527 - 40 / See art. 527 - 40

### Ricambi / Spare parts / Rechanges / Repuestos / Ersatzteile

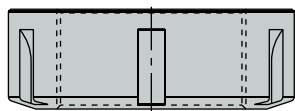

COD. RH

COD. LH

0527GH40R0

0527GH40L0

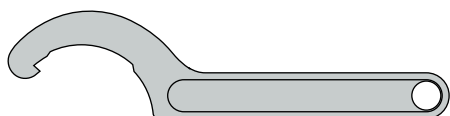

COD.

0303A62650

 Centric chuck HSK63F.

 Mandrin centré HSK63F.

 Mandril concéntrico HSK63F.

 Zentrisches Spannfutter HSK63F.



# 527 - 20

## Pinza elastica

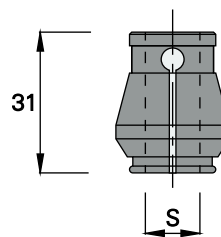

S	COD.
6	0527200600
6.35	0527200635
8	0527200800
9.5	0527200950
10	0527201000
11	0527201100
12	0527201200
12.7	0527201270
13	0527201300
14	0527201400

 Collet for chuck.

 Pinza para mandril.

 Pince pour mandrin.

 Spannzange.

# 527 - 22

## Pinza elastica "ER 20"

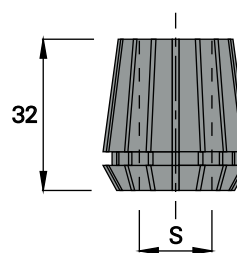

S	COD.
3	0527220300
4	0527220400
5	0527220500
6	0527220600
8	0527220800
10	0527221000
12	0527221200

 Collet "ER - 20" for chuck.

 Pinza "ER - 20" para mandril.

 Pince "ER - 20" pour mandrin.

 Spannzange "ER - 20".

# 527 - 25

## Pinza elastica

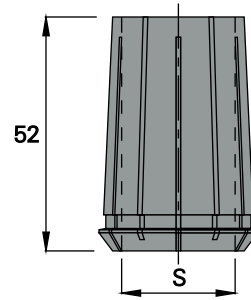

S

COD.

25

0527252500

 Collet for chuck.

 Pinza para mandril.

 Pince pour mandrin.

 Spannzange.

# 527 - 27

## Pinza elastica "ER 25"

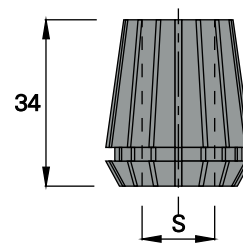

S

COD.

3

0527270300

4

0527270400

5

0527270500

6

0527270600

8

0527270800

10

0527271000

12

0527271200

14

0527271400

16

0527271600

 Collet "ER - 25" for chuck.

 Pinza "ER - 25" para mandril.

 Pince "ER - 25" pour mandrin.

 Spannzange "ER - 25" .

# 527 - 32

## Pinza elastica " ER 32 "

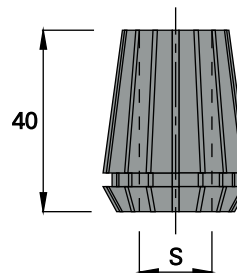

S	COD.
3	0527320300
4	0527320400
5	0527320500
6	0527320600
7	0527320700
8	0527320800
10	0527321000
12	0527321200
13	0527321300
14	0527321400
16	0527321600
18	0527321800
19	0527321900
20	0527322000



Collet " ER - 32 " for chuck.



Pinza " ER - 32 " para mandril.



Pince " ER - 32 " pour mandrin.



Spannzange " ER - 32 ".

# 527 - 40

## Pinza elastica " ER 40 "

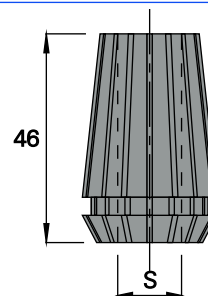

S	COD.
4	0527400400
5	0527400500
6	0527400600
7	0527400700
8	0527400800
10	0527401000
12	0527401200
13	0527401300
14	0527401400
16	0527401600
18	0527401800
19	0527401900
20	0527402000
25	0527402500



Collet " ER - 40 " for chuck.



Pinza " ER - 40 " para mandril.



Pince " ER - 40 " pour mandrin.



Spannzange " ER - 40 ".

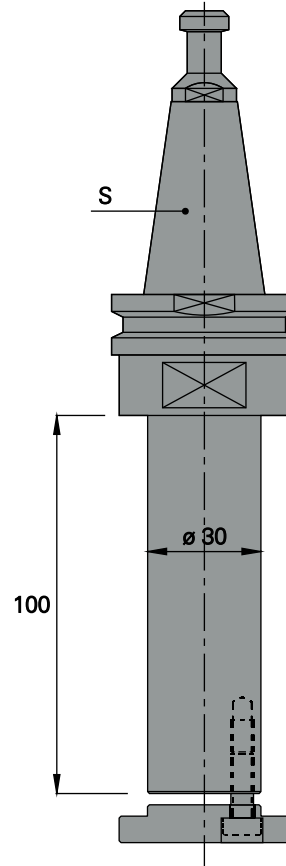

MACCHINA / MACHINE	S	COD. RH
BIESSE - MASTERWOOD	ISO 30	0528ABIERO
CMS - BULLERI - BUSELLATO	ISO 30	0528ACMSR0
ALBERTI	ISO 30	0528AALBR0

### Ricambi / Spare parts / Rechanges / Repuestos / Ersatzteile

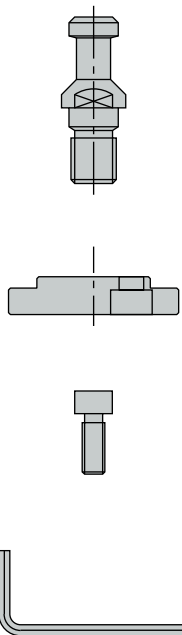

MACCHINA / MACHINE	COD.
BIESSE - MASTERWOOD	0527TIBIE0
CMS - BULLERI - BUSELLATO	0527TICMS0
ALBERTI	0527TIALB0
COD.	
	0528FLAN30
COD.	
	048072B616
COD.	
	048078Z050

Cutter arbor.

Mandril porta - fresas.

Mandrin porte - fraise.

Fräsdorn.

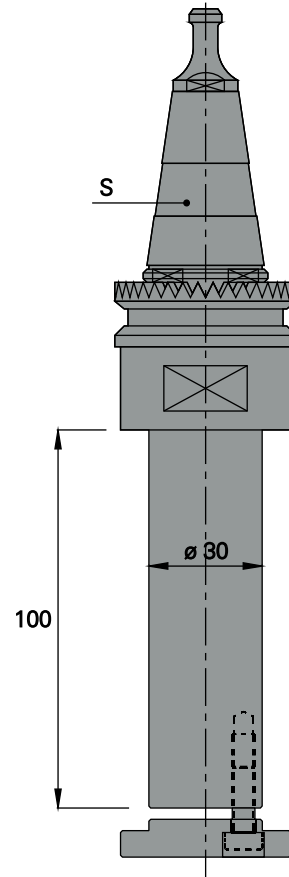

MACCHINA / MACHINE

S

COD. RH

MORBIDELLI - SCM

ISO 30

0528CSCM00

### Ricambi / Spare parts / Rechanges / Repuestos / Ersatzteile

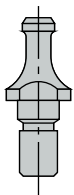

MACCHINA / MACHINE

COD.

MORBIDELLI - SCM

0527TISCM0

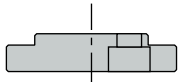

COD.

0528FLAN30



COD.

048072B616



COD.

048078Z050



Cutter arbor.



Mandril porta - fresas.



Mandrin porte - fraise.



Fräsdorn.

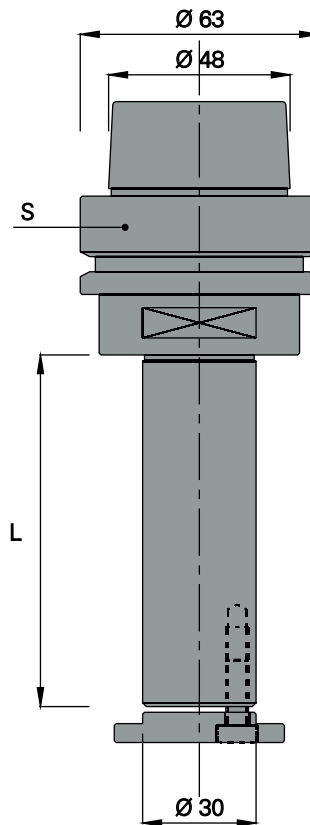

S	L	COD.
HSK63E	100	0528KEL100
HSK63E	130	0528KEL130
HSK63E	150	0528KEL150

Ricambi / Spare parts / Rechanges / Repuestos / Ersatzteile

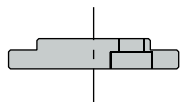

COD.
0528FLAN30



COD.
048072B616



COD.
048078Z050

 Cutter arbor HSK63E.

 Mandril porta - fresas HSK63E.

 Mandrin porte - fraise HSK63E.

 Fräsdorn HSK63E.

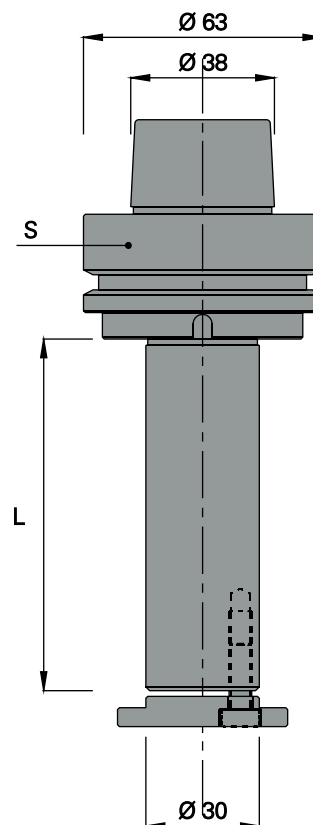

S	L	COD.
HSK63F	100	0528KFL100
HSK63F	130	0528KFL130
HSK63F	150	0528KFL150

### Ricambi / Spare parts / Rechanges / Repuestos / Ersatzteile

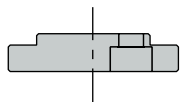

COD.
0528FLAN30



COD.
048072B616



COD.
048078Z050

 Cutter arbor HSK63F.

 Mandril porta - fresas HSK63F.

 Mandrin porte - fraise HSK63F.

 Fräsdorn HSK63F.

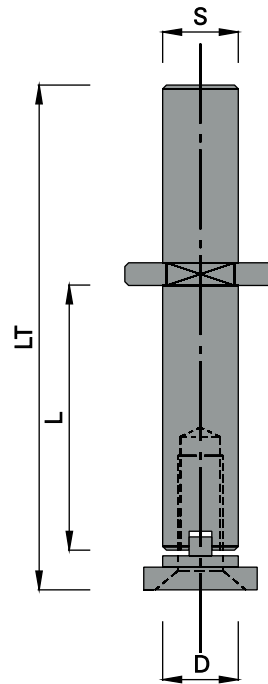

D	L	LT	S	COD.
20	70	134	20	0528N20000

Ricambi / Spare parts / Rechanges / Repuestos / Ersatzteile

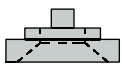

COD.

0528FLAN20

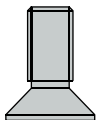

COD.

0480721230



COD.

048078Z080

 Cylindrical tool holder Ø 20.

 Mandril portafresas cilíndrico Ø 20.

 Arbre porte - fraise avec queue cylindrique Ø 20.

 Zylinder - Fräsdorn Ø 20.



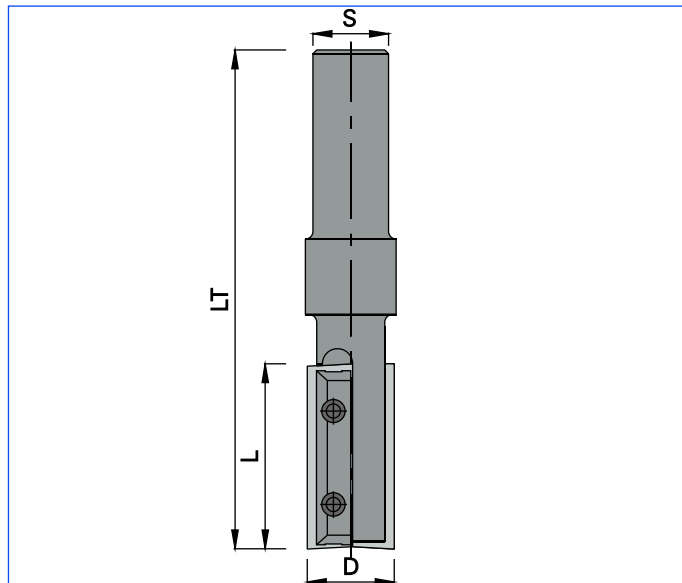

**HW**

**MEC**

n max 18000

D	L	LT	S	Z	COD.
23	49	137	20	2	0520B00000

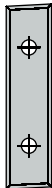

**Ricambi / Spare parts / Rechanges / Repuestos / Ersatzteile**

  
 COD.  
 048120B000

  
 COD.  
 0519R00000

  
 COD.  
 0480730409

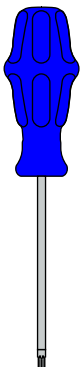
  
 COD.  
 048078T15E

 Plunging and jointing router cutter with turnover knives.

 Fresa router con cuchillas para agujerear y cantar.

 Fraise à rainurer et détourer avec plaquettes à jeter.

 Wendemesser - Oberfräser zum Bohren und Fügen.

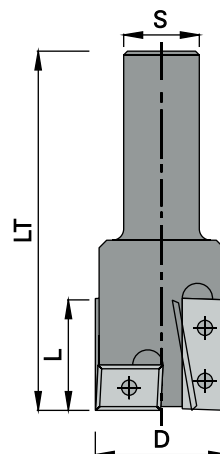

**HW**

**MEC**

n max 16000

D	L	LT	S	Z	COD.
35	28	95	20	2+2	0520C00000

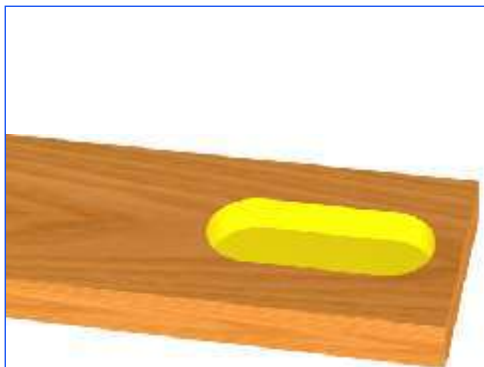

Ricambi / Spare parts / Rechanges / Repuestos / Ersatzteile

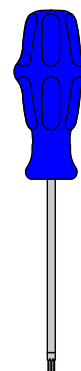
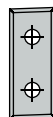

COD.	COD.	COD.	COD.
048120C175	048120C292	048074P350	048078T15E

Plunging and jointing router cutter with turnover knives.

Fresa router con cuchillas para agujerear y cantear.

Fraise à rainurer et détourer avec plaquettes à jeter.

Wendemesser - Oberfräser zum Bohren und Fügen.

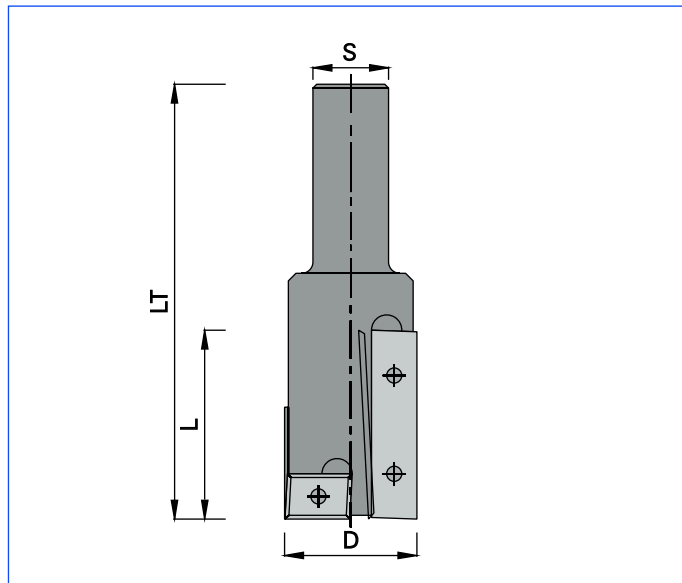



**HW**      **MEC**

n max 16000

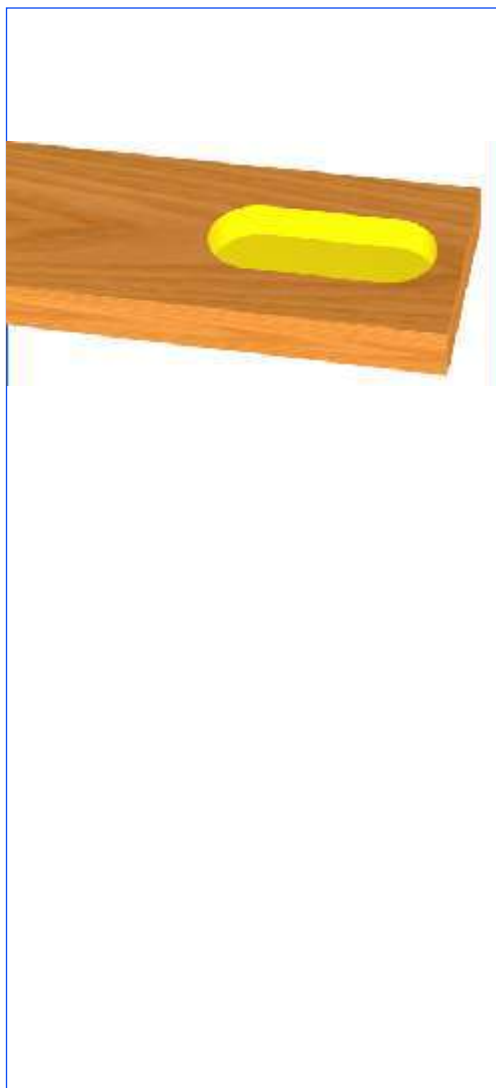
D	L	LT	S	Z	COD.
35	48	115	20	2+2	0520E00000

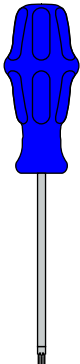

Ricambi / Spare parts / Rechanges / Repuestos / Ersatzteile

			
COD.	COD.	COD.	COD.
048120C175	048120E494	048074P350	048078T15E

 Plunging and jointing router cutter with turnover knives.

 Fresa router con cuchillas para agujerear y cantear.

 Fraise à rainurer et détourer avec plaquettes à jeter.

 Wendemesser - Oberfräser zum Bohren und Fügen.

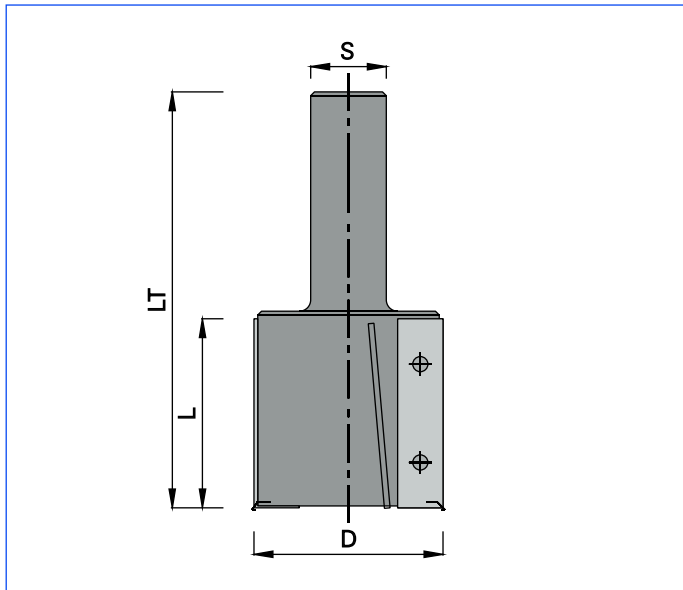

**HW**      **MEC**

n max 16000

D	L	LT	S	Z	V	COD.
50	50	102	20	2	2	0520F00000



Ricambi / Spare parts / Rechanges / Repuestos / Ersatzteile

COD.	COD.	COD.	COD.	COD.	COD.
0480030014	0480050050	048074A510	048074P350	048078T15E	048078T200

Rebating and jointing cutter head with turnover knives.

Fresa router con cuchillas para galcear y cantear.

Fraise à feullurer et détourer avec plaquettes à jeter.

Wendemesser - Oberfräser zum Falzen und Fügen.

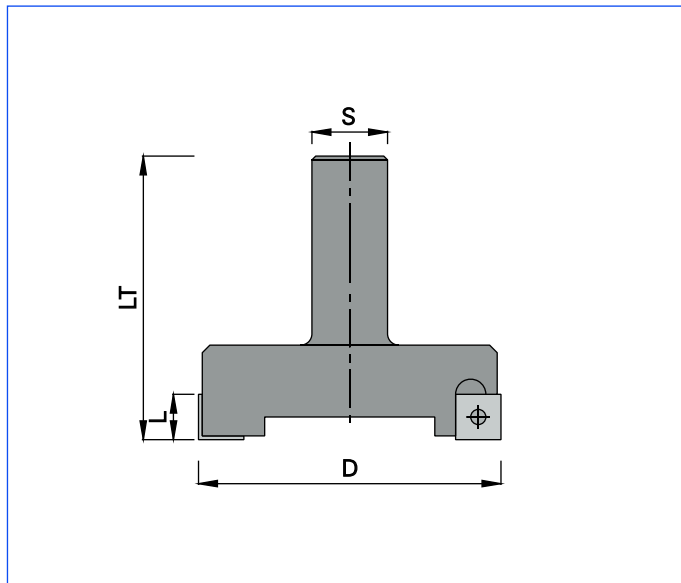

**HW**

**MEC**

n max 14000

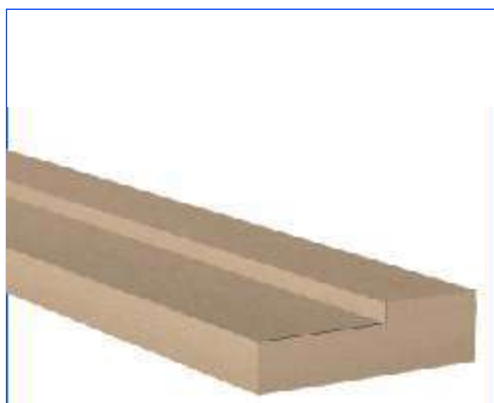

D	L	LT	S	Z	COD.
80	12	75	20	4	0520H00000

Ricambi / Spare parts / Rechanges / Repuestos / Ersatzteile

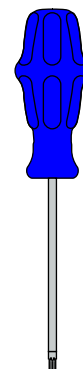

COD.

COD.

COD.

0480050012

048074P350

048078T15E

 Surfacing router cutter with turnover knives.

 Fresa router con cuchillas para planear.

 Fraise avec plaquettes à jeter pour surfacage.

 Wendemesser - Plänoberfräser.

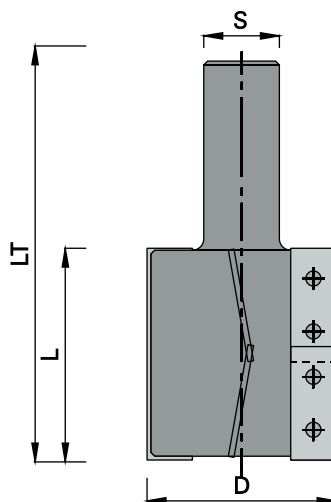

**HW**

**MEC**

n max 14000

D	L	LT	S	Z	COD.
50	56	106	20	2+2	0520L0000



**Ricambi / Spare parts / Rechanges / Repuestos / Ersatzteile**

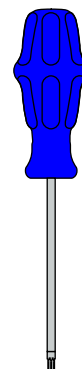

COD.

COD.

COD.

0480050030

048074P350

048078T15E

 Jointing router cutter with turnover knives.

 Fresa router con cuchillas para cantear.

 Fraise à détourer avec plaquettes à jeter.

 Wendemesser - Fügeoberfräser.

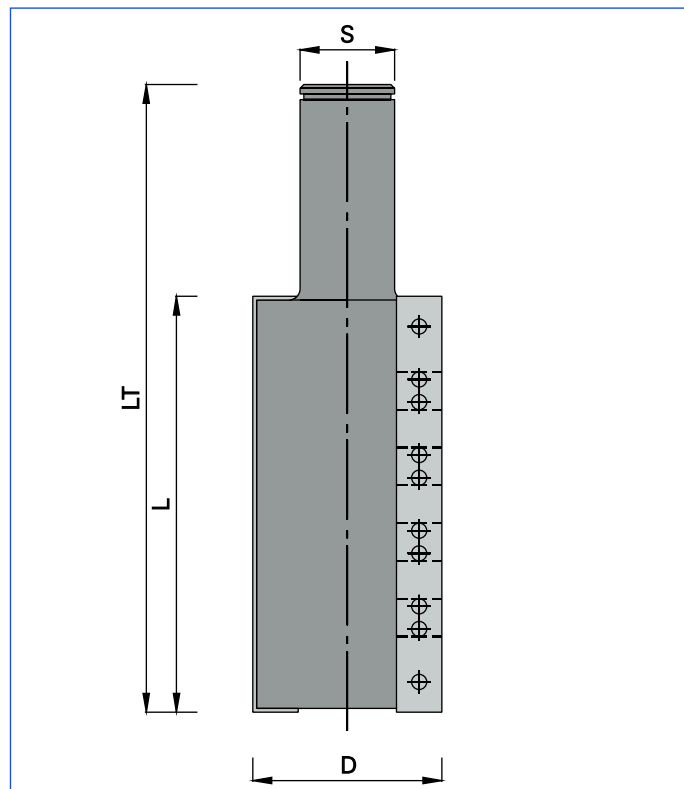

**HW**

**MEC**

n max 12000

D	L	LT	S	Z	COD.
50	110	166	25	2+2	0520P00000



**Ricambi / Spare parts / Rechanges / Repuestos / Ersatzteile**

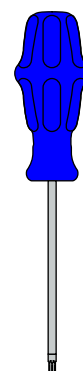
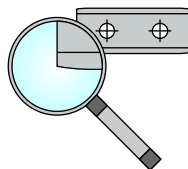

COD.

COD.

COD.

048015E300

048074P350

048078T15E

Roughing and jointing router cutter with turnover knives.

Fresa router con cuchillas para desbastar y cantar.

Fraise d'ébauche et de finition avec plaquettes à jeter.

Wendemesser - Schrupp - Oberfräser zum Fazen.

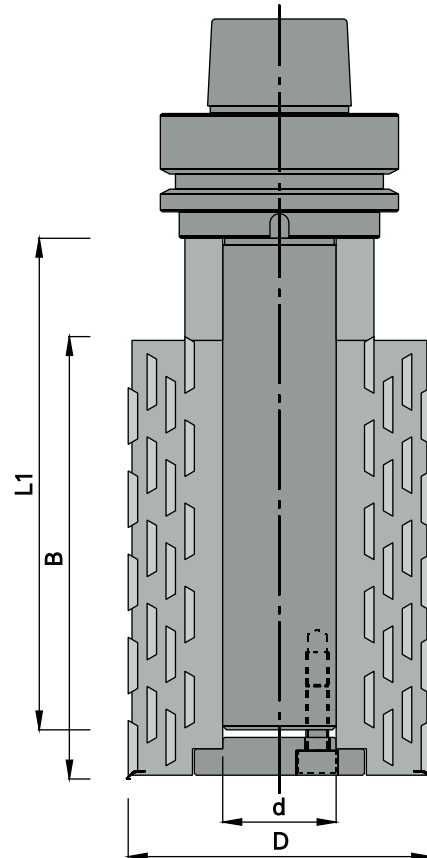

**HW**

**MEC**

n max 14300

D	B	L1	d	Z	V	COD.
80	115	130	30	4	2	0625A00000

Ricambi / Spare parts / Rechanges / Repuestos / Ersatzteile

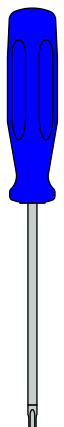

COD.	COD.	COD.	COD.	COD.
0480030014	048125A000	048074A510	048074C514	048078T200

 Cutter head on tool holder HSK63F for roughing and jointing.

 Cabezal para desbastar y cantear completo de mandril HSK63F.

 Porte - outil d'ébauche et de finition complet d'arbre HSK63F.

 Schrupp - und - Fügemeserkopf mit Fräsdorn HSK63F.



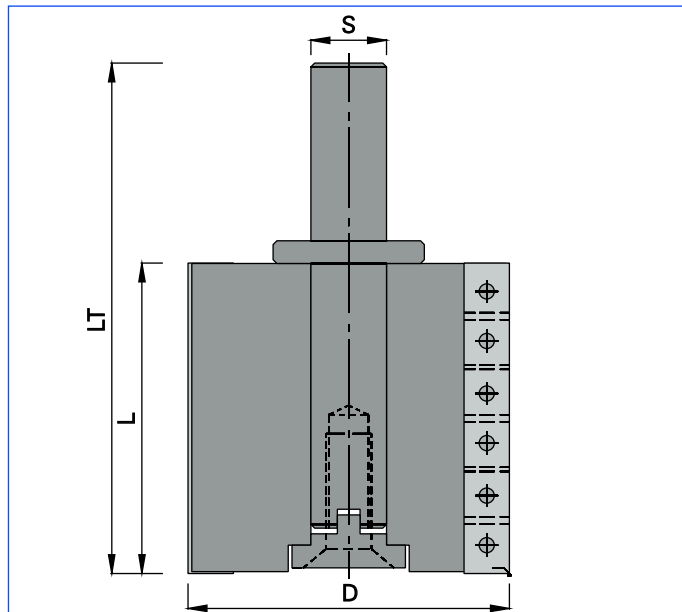

**HW**      **MEC**

n max 12000

D	L	LT	S	Z	V	COD.
85	83	136	20	4	2	0625C00000



Ricambi / Spare parts / Rechanges / Repuestos / Ersatzteile

COD.	COD.	COD.	COD.
04800030014	0480050015	048050K011	048060H000

COD.	COD.	COD.	COD.
048072B620	048074A510	048078L500	048078T200

Roughing and jointing router cutter with turnover knives.	Fresa router con cuchillas para desbastar y cantear.
Fraise d'ébauche et de finition avec plaquettes à jeter.	Wendemesser - Schrupp - Oberfräser zum Fazen.

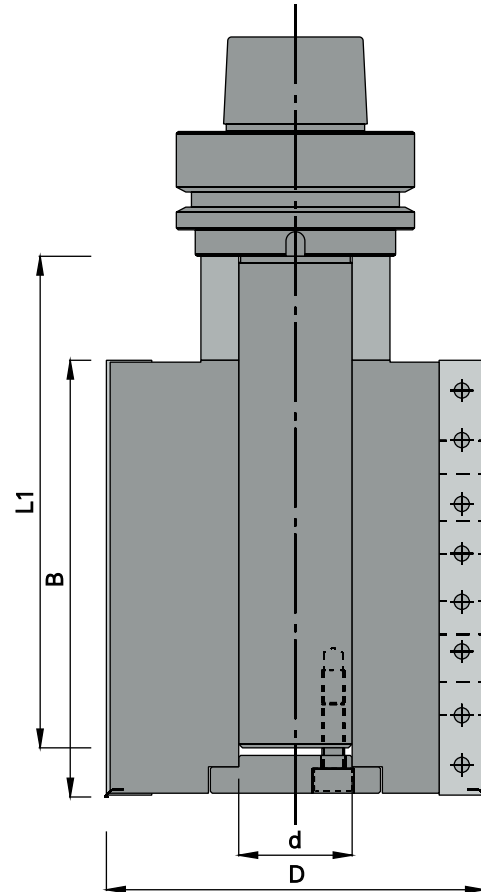

**HW**

**MEC**

n max 10500

D	B	L1	d	Z	V	COD.
100	115	130	30	6	3	0625E00000

**Ricambi / Spare parts / Rechanges / Repuestos / Ersatzteile**



COD.

0480030014

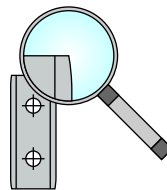

COD.

048015E300



COD.

04805715EC



COD.

04805715EL



COD.

048060C000



COD.

0480700612



COD.

048074A510

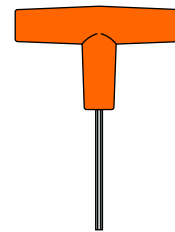

COD.

0480783000

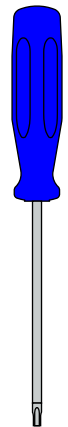

COD.

048078T200

 Jointing cutter head on tool holder HSK63F.

 Cabezal para cantear completo de mandril HSK63F.

 Porte - outil à détourer complet d'arbre HSK63F.

 Fügemeserkopf mit Fräsdorn HSK63F.

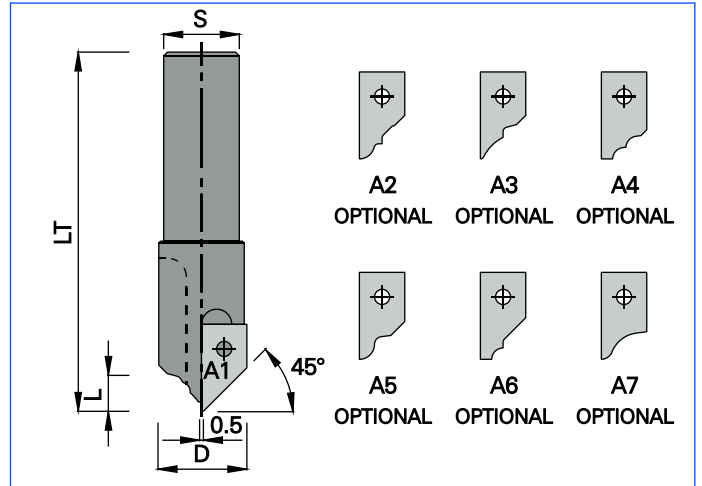

**HW**      **MEC**

n max 20000

D	L	LT	S	Z	COD.
24	11	95	20	1	0626A00000

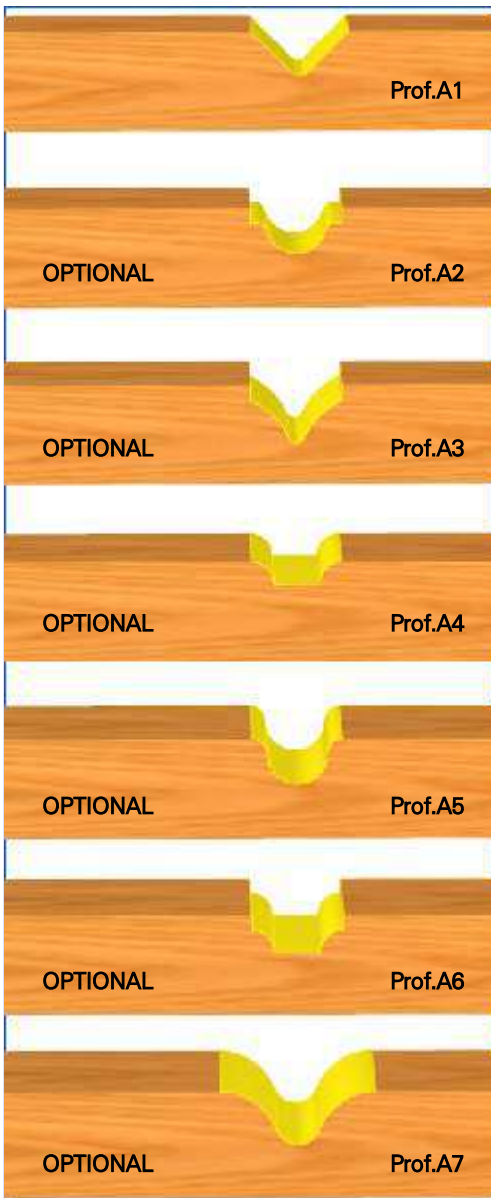

**Ricambi / Spare parts / Rechanges / Repuestos / Ersatzteile**

A1	A2	A3	A4	A5
COD.	COD.	COD.	COD.	COD.
048126A100	048126A200	048126A300	048126A400	048126A500
A6	A7			
COD.	COD.	COD.	COD.	
048126A600	048126A700	048074P350	048078T15E	

Multiprofile router cutter with profiled knives.

Fresa router multiperfil con cuchillas perfiladas.

Fraise pour rainures décoratives avec plaquettes à jeter.

Multiprofil - Oberfräser mit Profilmesser.

# 626 - C

## Fresa integrale per incisioni

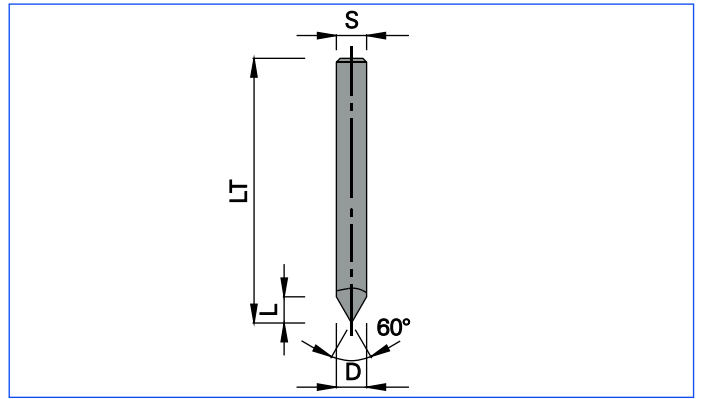

**HW**

**MEC**



D	L	LT	S	Z	COD.
8	6	70	8	1	0626C00000

Engraving router bit.

Broca para cortar.

Mèche a graver.

Oberfräser für schnitzen.

# 626 - E

## Fresa ad inserti con inclinazione a 45°

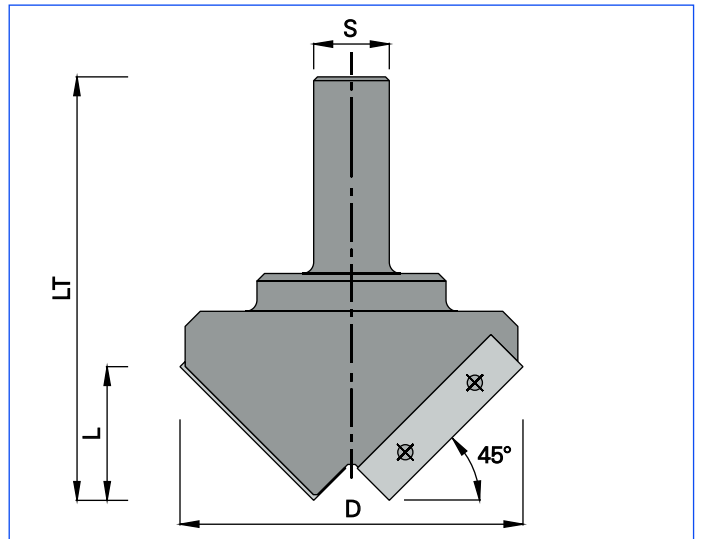

**HW**

**MEC**

n max 12000



D	L	LT	S	Z	COD.
90	35	105	20	2	0626E00000

Ricambi / Spare parts / Rechanges / Repuestos / Ersatzteile

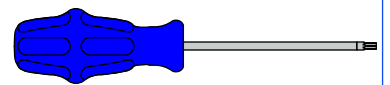

COD.

COD.

COD.

0480050050

048074P350

048078T15E

45° chamfer router cutter with turnover knives.

Fresa router con cuchillas para biselar a 45°.

Fraise avec plaquettes à jeter pour chanfrein à 45°.

Wendemesser - Oberfräser für 45° Fase.

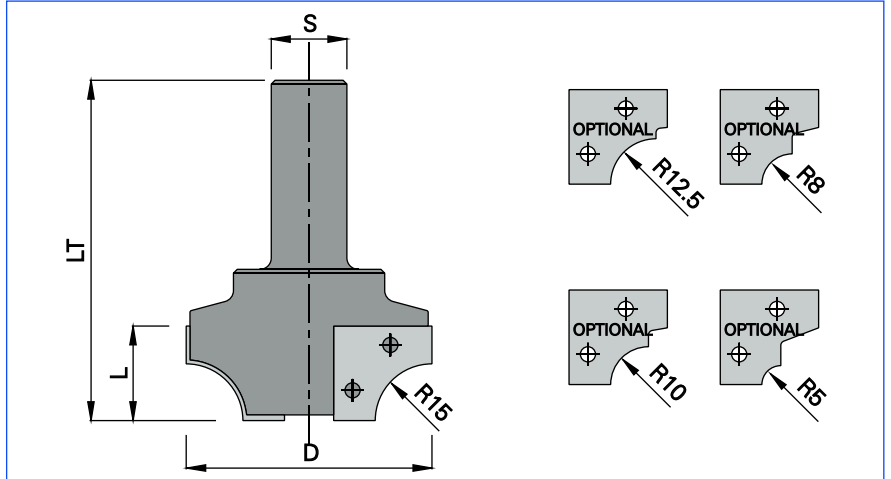

**HW**      **MEC**

n max 14000

D	L	LT	S	Z	COD.
65	24	90	20	2	0626R00000

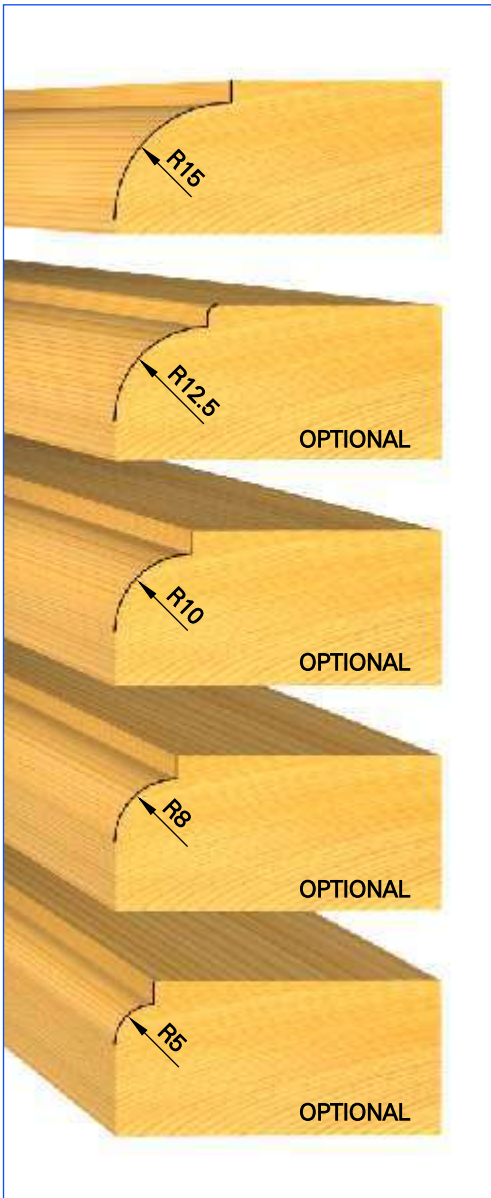

Ricambi / Spare parts / Rechanges / Repuestos / Ersatzteile

COD.	COD.	COD.	COD.	COD.
048126R150	048126R120	048126R100	048126R080	048126R050

COD.	COD.
048074P460	048078T15E

Multiprofile router cutter with rounding knives.

Fresa router multiperfil con cuchillas para redondear.

Fraise multiprofiles avec plaquettes à jeter pour quart de rond.

Multiprofil - Oberfräser mit Profilmesser zum Abrunden.

# K 420 - PA20

Fresa ad inserti con inclinazione  
variabile, regolabile da - 45° a + 90°

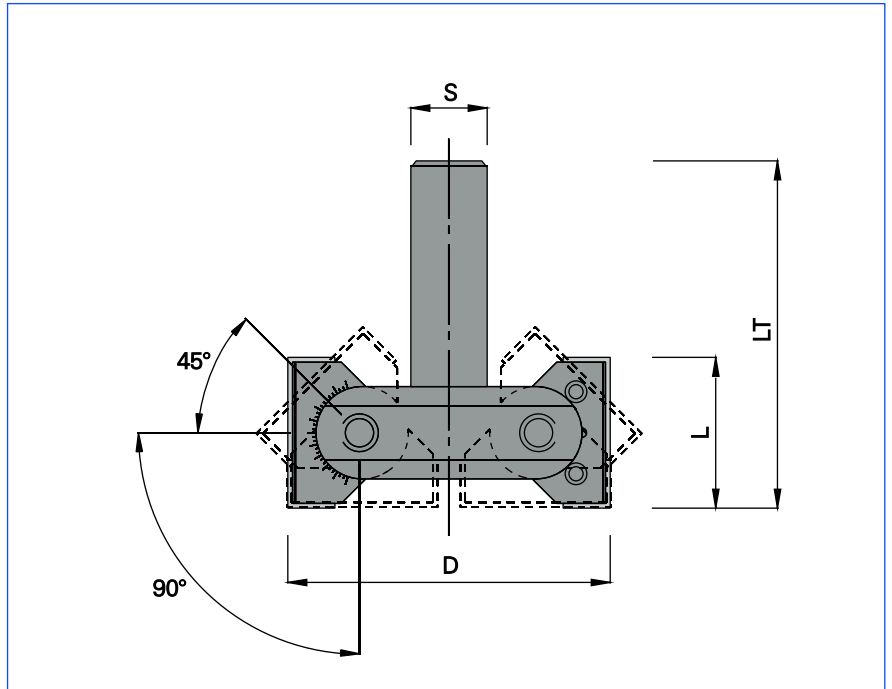

**HW**

**MEC**

n max 12000

D	L	LT	S	Z	COD.
85	40	100	20	2	K420PA2000

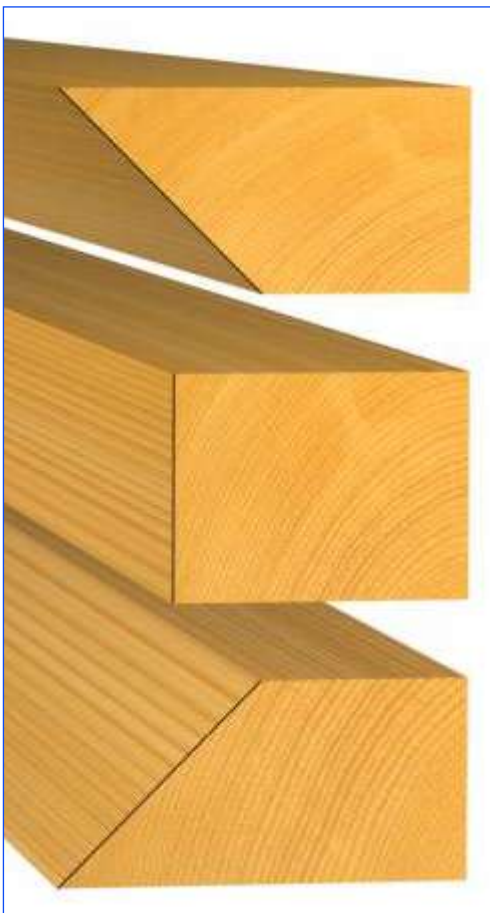

## Ricambi / Spare parts / Rechanges / Repuestos / Ersatzteile

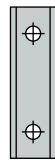

COD.	COD.	COD.	COD.
0480050040	048050ZPA0	048060P000	0480700608

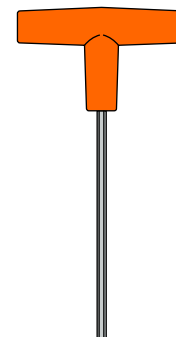
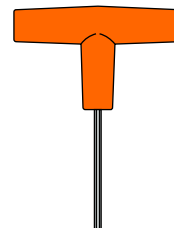

COD.	COD.	COD.
048072B516	0480783000	048078L400

 Router cutter with turnover knives for chamfer adjustable - 45° / + 90°.

 Fresa con cuchillas para biselado regulable desde - 45° hasta + 90°.

 Porte - outil à chanfreiner avec plaquettes à jeter inclinable de - 45° à + 90°.

 Wendemesser - Oberfräser für Verstell. Fase - 45° / + 90°.

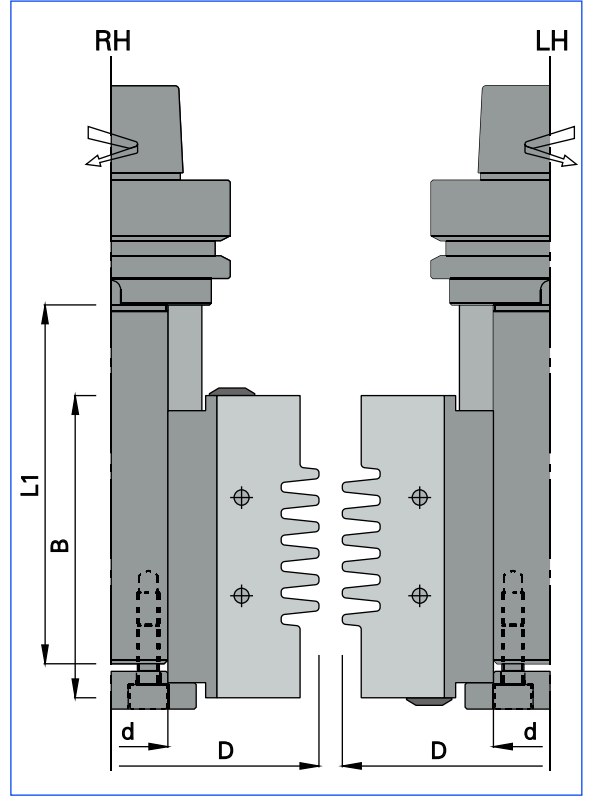

**HW**      **MEC**

n max 10400

ROT.	D	B	L1	d	Z	COD.
RH	110	80	100	30	2	0628A000RH
LH	110	80	100	30	2	0628A000LH

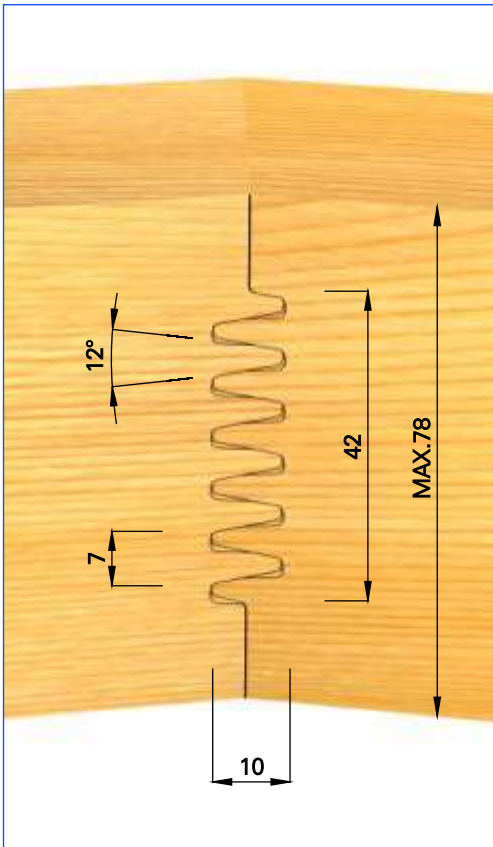

**Ricambi / Spare parts / Rechanges / Repuestos / Ersatzteile**

COD.	COD.	COD.
K48028F000	0480527825	0480700820
COD.	COD.	
048073B000	048078L400	

Glue jointing cutter heads on tool holder HSK63F.

Cabezas para ensamble completos de mandril HSK63F.

Porte - outils pour abouter complets d'arbre HSK63F.

Verleim - Messerköpfe mit Fräsdorn HSK63F.

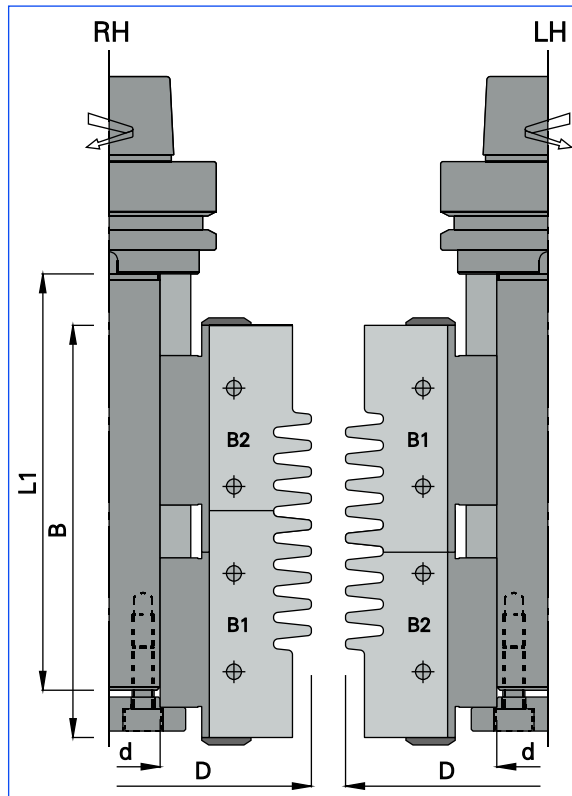

**HW**

**MEC**

n max 10400

ROT.	D	B	L1	d	Z	COD.
RH	110	116	120	30	2	0628B000RH
LH	110	116	120	30	2	0628B000LH

Ricambi / Spare parts / Rechanges / Repuestos / Ersatzteile

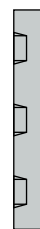
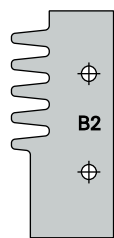
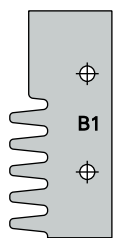

COD.	COD.	COD.
048128B100	048128B200	0480525825

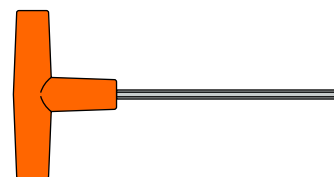

COD.	COD.	COD.
0480700820	048073B000	048078L400

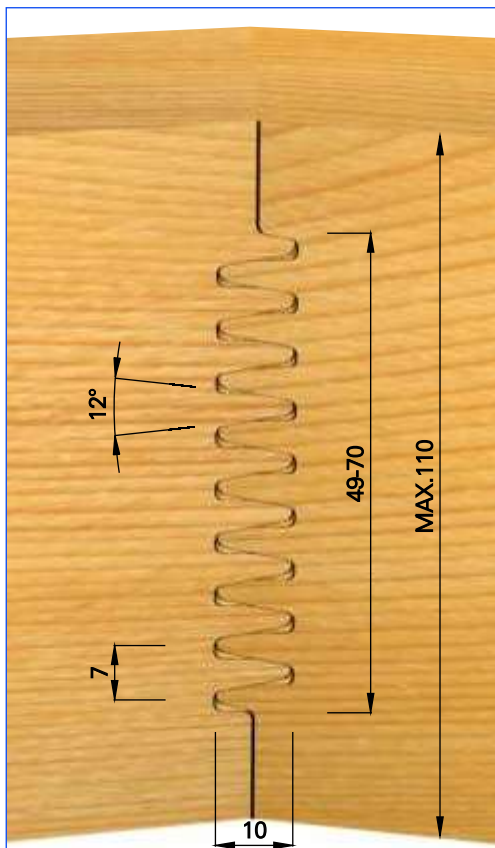

Glue jointing cutter head set on tool holder HSK63F.

Juego de cabezales para ensamble completos de mandril HSK63F.

Jeu de porte - outils pour abouter complets d'arbre HSK63F.

Verleim - Messerköpfsatz mit Fräsdorn HSK63F.



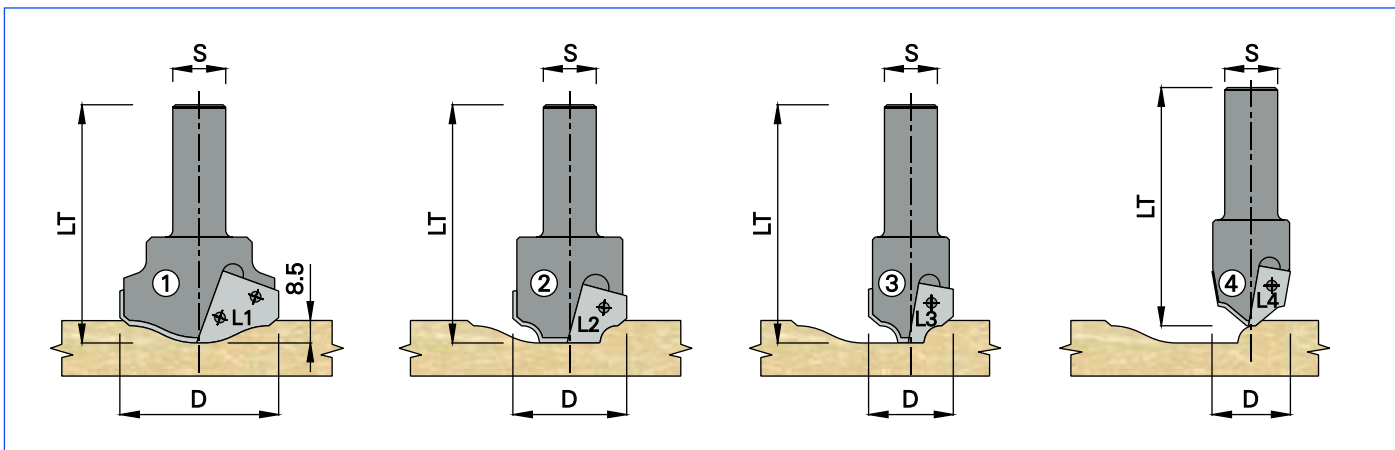

**HW**                      **MEC**

① n max 16000  
② ③ ④ n max 20000

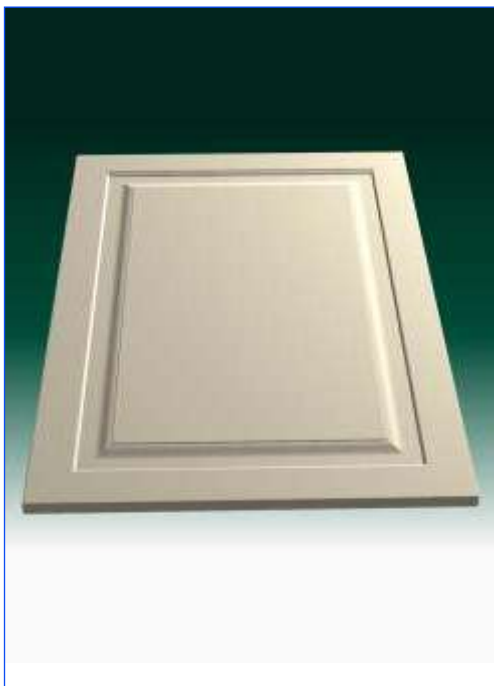

D	S	Z	LT	COD. ①	COD. ②	COD. ③	COD. ④
60	20	2	90	0626L10000			
43	20	2	90		0626L20000		
32	20	2	90			0626L30000	
30	20	2	90				0626L40000

SET COMPLETO / COMPLETE SET	COD. SET
① + ② + ③ + ④	0626L00000

Ricambi / Spare parts / Rechanges / Repuestos / Ersatzteile

COD.	COD.	COD.	COD.
048126L100	048126L200	048126L300	048126L400
COD.	COD.	COD.	
048074P350	048074P460	048078T15E	

Set of 4 router cutters with profiled knives for cabinet doors.

Juego de 4 fresas router con cuchillas para puertas de muebles.

Jeu de 4 fraises avec plaquettes à jeter pour portes de meubles.

Satz von 4 Oberfräser mit Profilmesser für Möbeltüren.

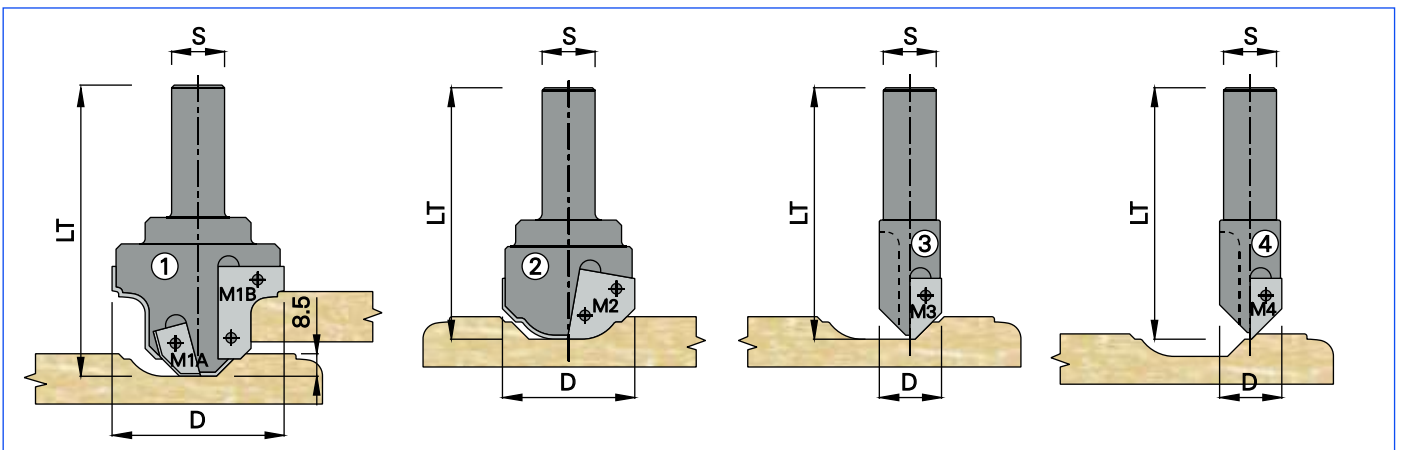

**HW**      **MEC**

① ② n max 16000  
③ ④ n max 20000

D	S	Z	LT	COD.①	COD.②	COD.③	COD.④
65	20	2+2	110	0626M10000			
50	20	2	95		0626M20000		
24	20	1	95			0626M30000	
24	20	1	95				0626M40000

SET COMPLETO / COMPLETE SET	COD. SET
① + ② + ③ + ④	0626M00000



Ricambi / Spare parts / Rechanges / Repuestos / Ersatzteile

M1A	M1B	M2	M3	M4
COD.	COD.	COD.	COD.	COD.
048126M1A0	048126M1B0	048126M200	048126M300	048126M400
COD.	COD.	COD.		
048074P350	048074P460	048078T15E		

Set of 4 router cutters with profiled knives for cabinet doors. Juego de 4 fresas router con cuchillas para puertas de muebles.

Jeu de 4 fraises avec plaquettes à jeter pour portes de meubles. Satz von 4 Oberfräser mit Profilmesser für Möbeltüren.

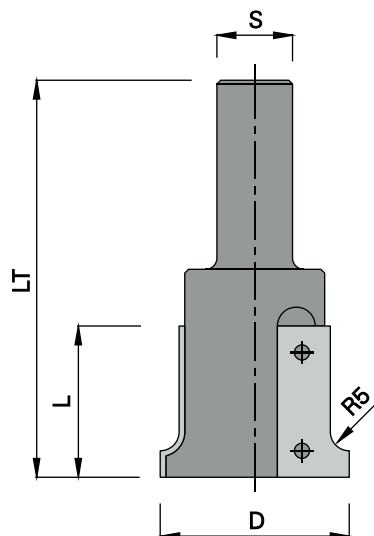

**HW**

**MEC**

n max 14000

D	L	LT	S	Z	COD.
50	40	105	20	2	0631E00000

Ricambi / Spare parts / Rechanges / Repuestos / Ersatzteile

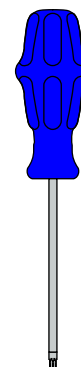
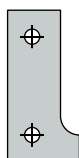
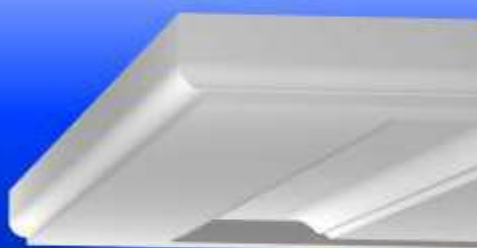

COD.

COD.

COD.

048131E000

048074P460

048078T15E



Router cutter with profiled knives for cabinet door profiling.



Fresa router con cuchillas para perfilar puertas de muebles.



Fraise avec plaquettes à jeter pour détournage des portes de meubles.



Profilmesser - Oberfräser zu Möbeltüren Profilierung.

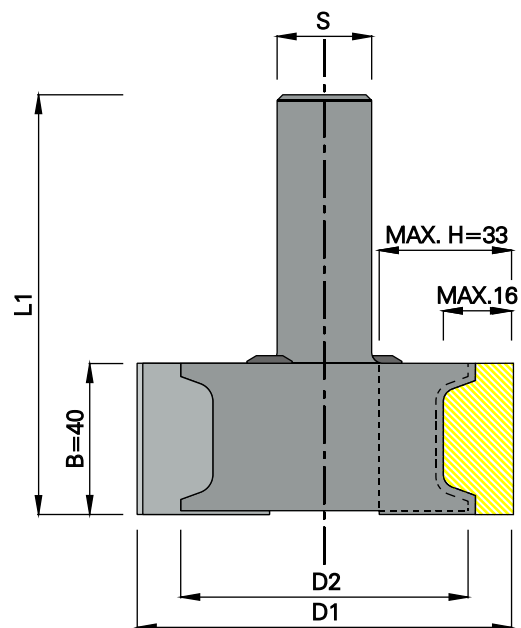

AREA PROFILABILE / PROFILING AREA

**HW**

**MEC**

n max 12000

D1	D2	L1	S	Z	COD.
95	76	110	25	2	0629A00000

La testa viene fornita senza piastrine di supporto ed inserti

### Piastrine di supporto Cod.0401G40335

	Support plates Cod.0401G40335
	Plaquettes de support Cod.0401G40335
	Plaquetas de soporte Cod.0401G40335
	Stützplatten Cod.0401G40335

### Inserti in HW Cod.0402G40352

	TC inserts Cod.0402G40352
	Plaquettes en HW Cod.0402G40352
	Cuchillas de HW Cod.0402G40352
	HW - Platten Cod.0402G40352

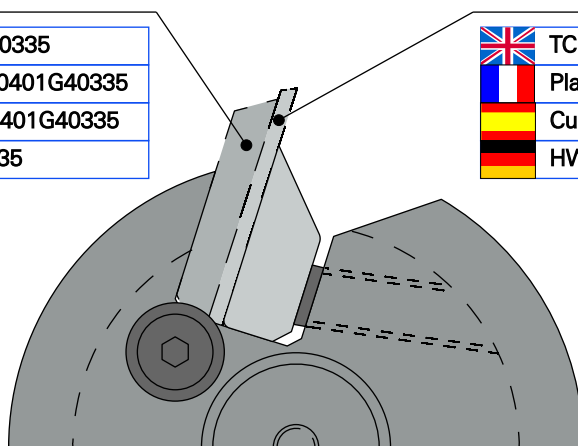

### Ricambi / Spare parts / Rechanges / Repuestos / Ersatzteile

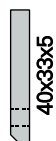

COD.  
0401G40335



COD.  
0402G40352



COD.  
04805138GA



COD.  
0480700820



COD.  
048073B000

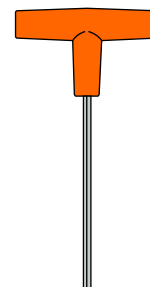

COD.  
048078L400

Multiprofile router cutter without plates.

Porte - outil multi profil sans plaquettes.

Fresa router multiperfil sin cuchillas.

Multiprofil - Oberfräser ohne Platten.

Lavorazione antina in massello  
ART. 626-G / 626-H / 627-E

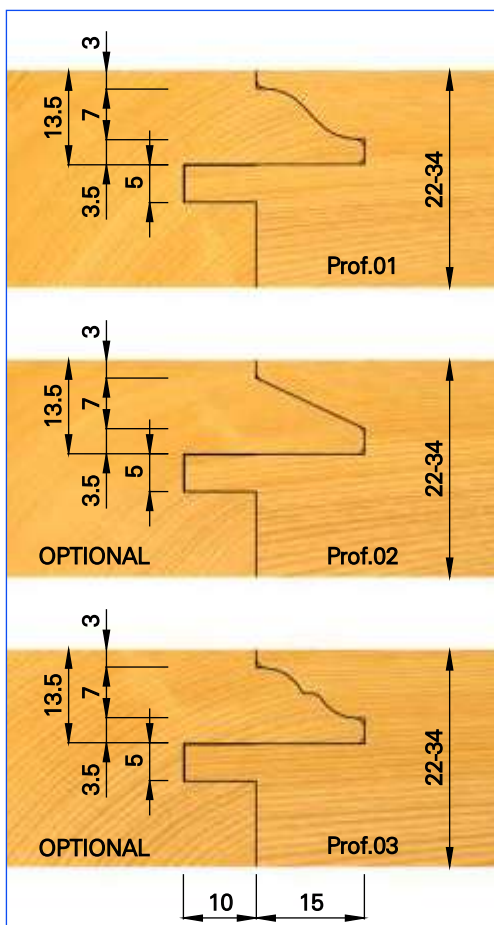

 Solid wood cabinet door Art.626-G/626-H/627-E.

 Puertas de muebles de madera maciza Art.626-G/626-H/627-E.

 Portes de meubles en massif Art.626-G/626-H/627-E.

 Massivholzmöbeltüren Art.626-G/626-H/627-E.

# 626 - G

## Fresa ad inserti multiprofilo per antenna in massello / profilo

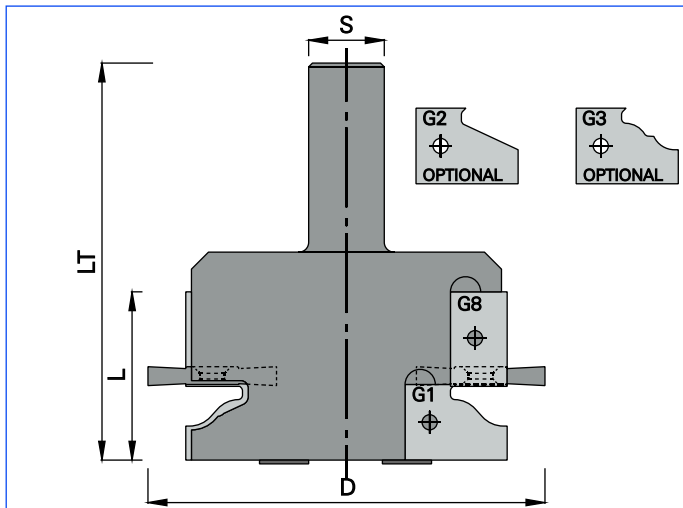

**HW**

**MEC**

n max 11000

D	L	LT	S	Z	COD.
105	44	100	20	2 + 2	0626G00000

# 626 - H

## Fresa ad inserti multiprofilo per antenna in massello / controprofilo

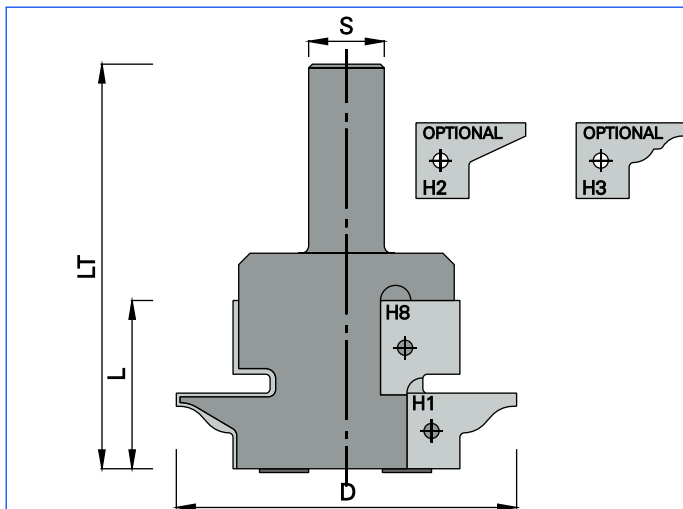

**HW**

**MEC**

n max 12000

D	L	LT	S	Z	COD.
90	44	110	20	2 + 2	0626H00000

### Ricambi / Spare parts / Rechanges / Repuestos / Ersatzteile



COD.  
048126G800

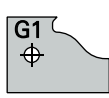

COD.  
048126G100



COD.  
048126G200



COD.  
048126G300



COD.  
048126H800

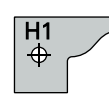

COD.  
048126H100

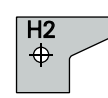

COD.  
048126H200

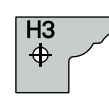

COD.  
048126H300



COD.  
048074P460



COD.  
048073A000



COD.  
048074C515



COD.  
048019C00S

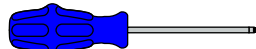

COD.  
048078T15E

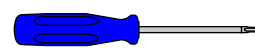

COD.  
048078T200

Multiprofile router cutters with profiled knives for solid wood cabinet doors (profile / counterprofile).

Fraiser multiprofil avec plaquettes pour portes de meubles en massif (profil / contre - profil).

Fresa router multiperfil con cuchillas para puertas de muebles de madera maciza (perfil / contraperfil).

Multiprofil - Oberfräser mit Porfilmesser für Massivholzmöbeltüren (Profil / Konterprofil).

Lavorazione antina in massello  
ART. 626-S / 626-T / 627-E.

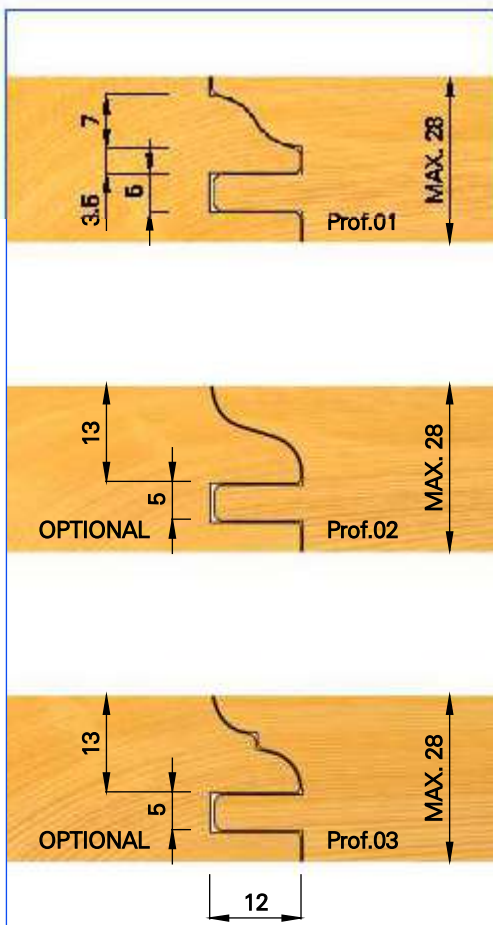

 Solid wood cabinet door Art.626-S/626-T/627-E.

 Puertas de muebles de madera maciza Art.626-S/626-T/627-E.

 Portes de meubles en massif Art.626-S/626-T/627-E.

 Massivholzmöbeltüren Art.626-S/626-T/627-E.

# 626 - S

## Fresa ad inserti multiprofilo per antenna in massello / profilo

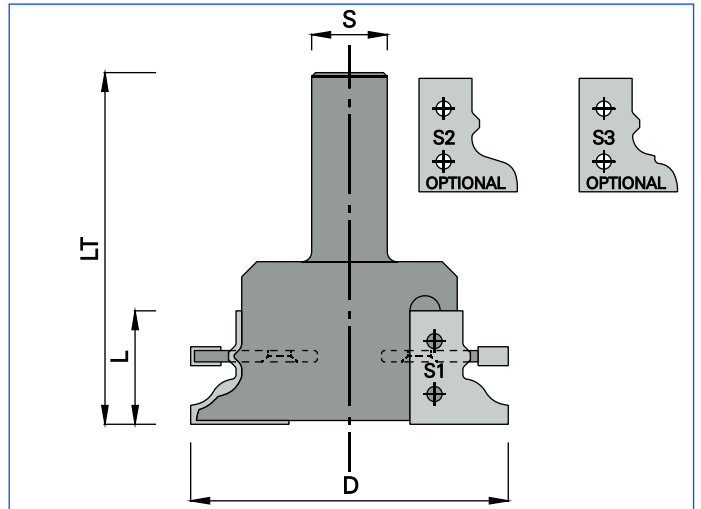

**HW**

**MEC**

n max 12000

D	L	LT	S	Z	COD.
84	30	93	20	2+2	0626S00000

# 626 - T

## Fresa ad inserti multiprofilo per antenna in massello / controprofilo

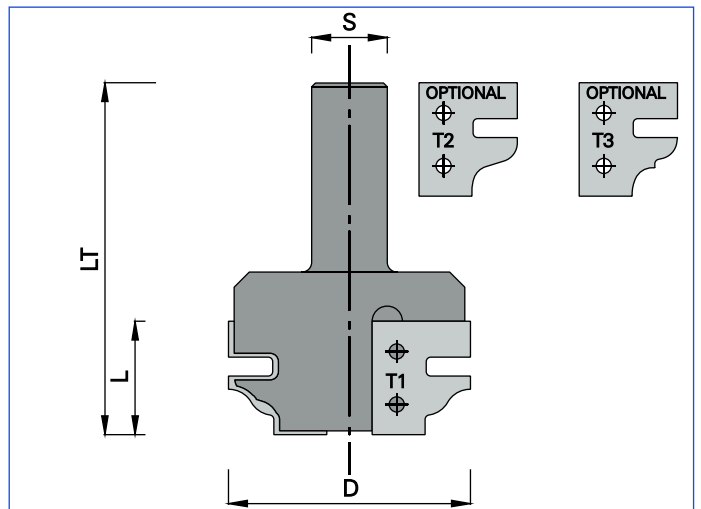

**HW**

**MEC**

n max 14000

D	L	LT	S	Z	COD.
64	30	93	20	2	0626T00000

### Ricambi / Spare parts / Rechanges / Repuestos / Ersatzteile

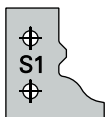

COD.  
048126S100

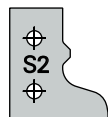

COD.  
048126S200

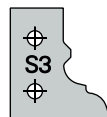

COD.  
048126S300

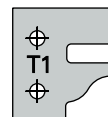

COD.  
048126T100

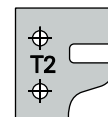

COD.  
048126T200

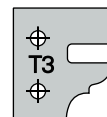

COD.  
048126T300



048074P460



048074C515



048017R000



048078T15E

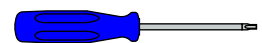

048078T200

Multiprofile router cutters with profiled knives for solid wood cabinet doors (profile / counterprofile).

Fresa router multiperfil con cuchillas para puertas de muebles de madera maciza (perfil / contraperfil).

Fraise multiprofil avec plaquettes pour portes de meubles en massif (profil / contre - profil).

Multiprofil - Oberfräser mit Porfilmesser für Massivholzmöbeltüren (Profil / Konterprofil).



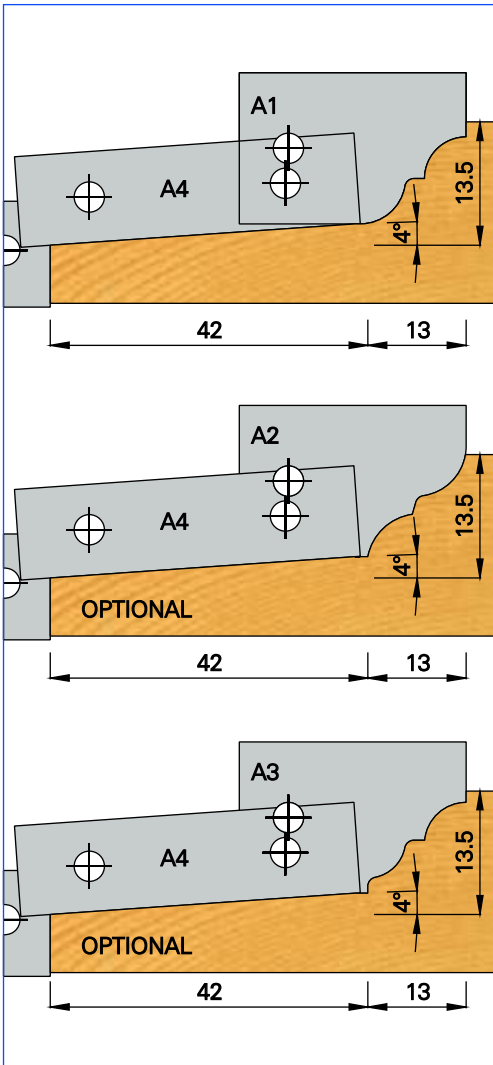
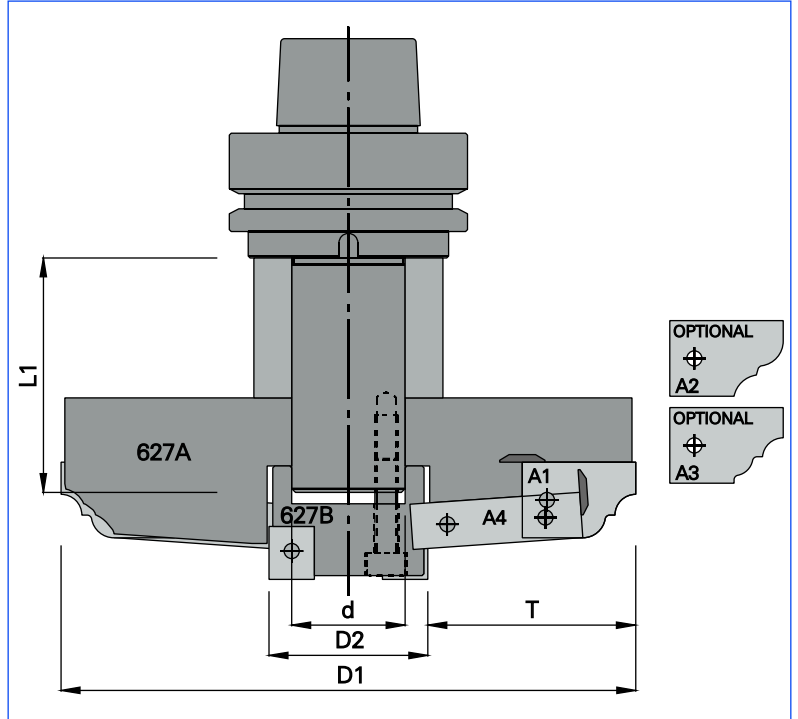

<b>HW</b>	<b>MEC</b>	n max 7300
-----------	------------	------------

D1	D2	L1	d	T	Z	COD.
152	42	75	30	55	3+3	0627AB0000

**Ricambi / Spare parts / Rechanges / Repuestos / Ersatzteile**

COD. 0480050014	COD. 048127A400	COD. 048127A100	COD. 048127A200	COD. 048127A300	COD. 0480503600
COD. 048053182L	COD. 048060C000	COD. 0480700612	COD. 0480700820	COD. 048074P350	COD. 048073B000
COD. 0480783000	COD. 048078L400	COD. 048078L500	COD. 048078T15E	COD. 0627B00000	

Multiprofile cutter head set on tool holder HSK63F.

Juego de cabezales multiperfiles para plafones completo de mandril HSK63F.

Jeu de porte - outils complet d'arbre HSK63F.

Multi - Profiler Abplatt - Messerkopf, satz komplett mit Fräsdorn HSK63F.

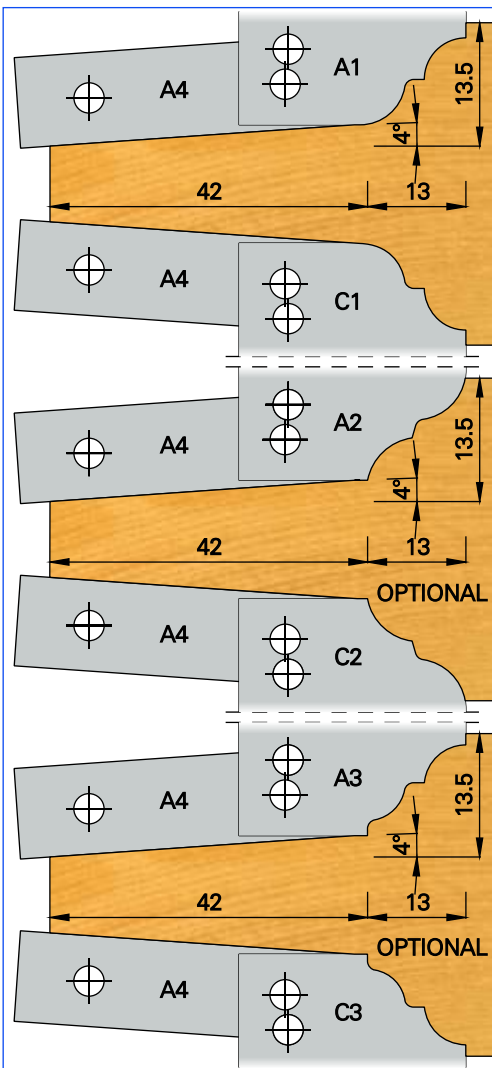
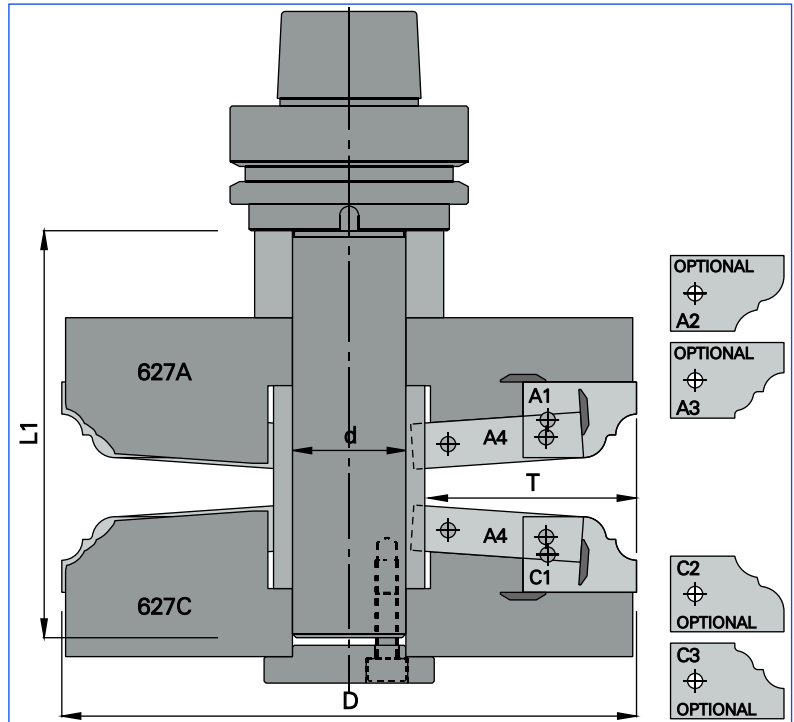

<b>HW</b>	<b>MEC</b>	n max 7300
-----------	------------	------------

D	L1	d	T	Z	COD.
152	110	30	55	3+3	0627AC0000

**Ricambi / Spare parts / Rechanges / Repuestos / Ersatzteile**

COD. 048127A100	COD. 048127A200	COD. 048127A300	COD. 048127C100	COD. 048127C200	COD. 048127C300
COD. 048127A400	COD. 0480503600	COD. 048053182L	COD. 048053182R	COD. 048060C000	
COD. 0480700612	COD. 0480700820	COD. 048073B000	COD. 0480783000	COD. 048078L400	COD. 048078L500

Multiprofile cutter head set on tool holder HSK63F.

Juego de cabezales multiperfiles para plafones completo de mandril HSK63F.

Jeu de porte - outils complet d'arbre HSK63F.

Multi - Profiler Abplatt - Messerkopf, satz komplett mit Fräsdorn HSK63F.

# 627 - F Fresa ad inserti multiprofilo per piattabanda

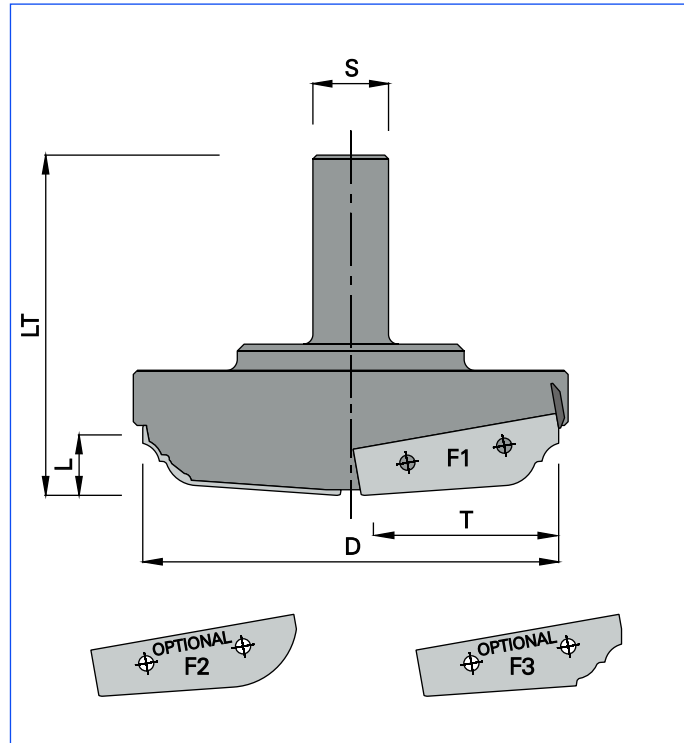

<b>HW</b>	<b>MEC</b>
n max 12000	

D	L	LT	S	Z	T	COD.
110	16	90	20	3	49	0627F00000

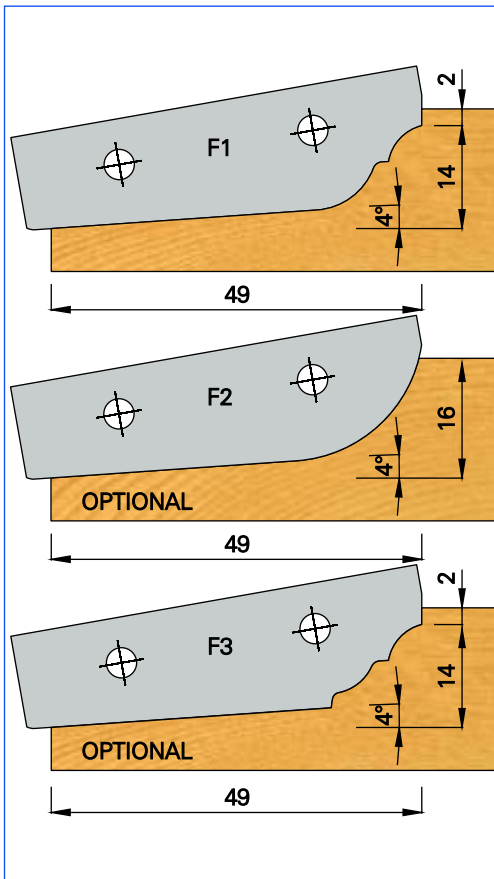

Ricambi / Spare parts / Rechanges / Repuestos / Ersatzteile

COD.	COD.	COD.	COD.	COD.	COD.
048127F100	048127F200	048127F300	048074P350	048073B000	048078T15E

Multiprofile raised router cutter with profiled knives.

Fresa router multiperfiles con cuchillas perfiladas para plafones.

Fraise multi - profil avec plaquettes à jeter pour plate - bandes.

Multi - profiler Abplatt - Oberfräser mit Profilmesser.

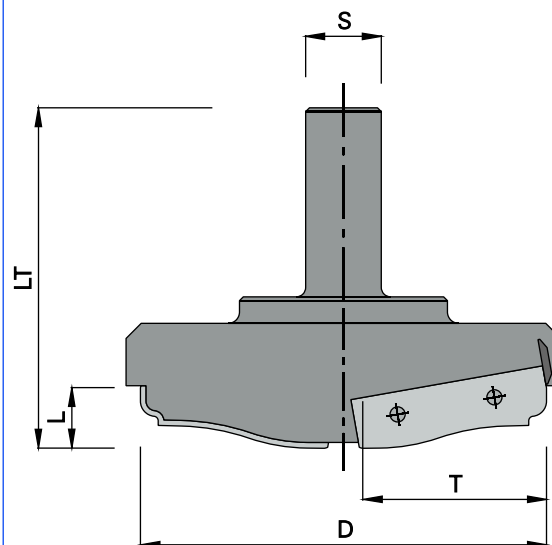

**HW**

**MEC**

n max 12000

D	L	LT	S	Z	T	COD.
108	15	90	20	3	48	0627E00000

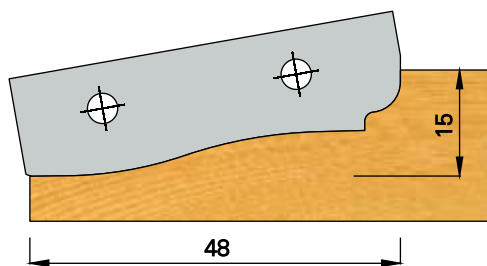

Ricambi / Spare parts / Rechanges / Repuestos / Ersatzteile

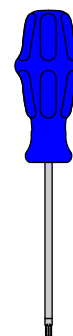

COD.

COD.

COD.

COD.

048127E000

048074P350

048073B000

048078T15E

Raised panel router cutter with profiled knives.

Fresa router con cuchillas perfiladas para plafones.

Fraise avec plaquettes à jeter pour plate - bandes.

Abplatt - Oberfräser mit Profilmesser.

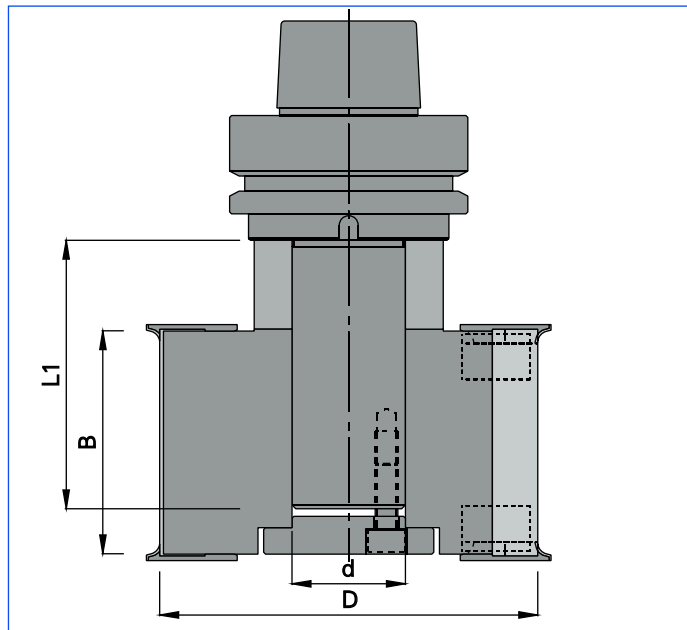

**HW**

**MEC**

n max 11400

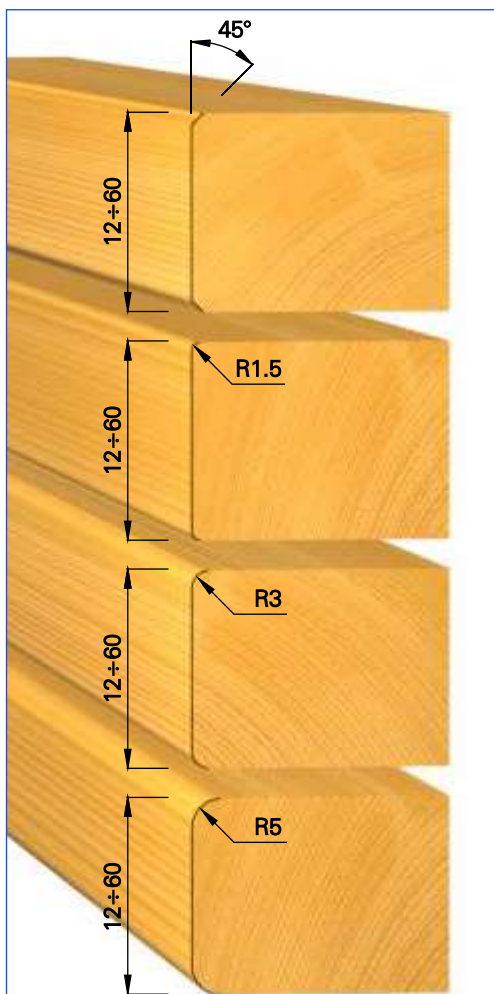

D	B	d	L1	Z	LS	45° COD.	R 1.5 COD.	R 3 COD.	R 5 COD.
100	60	30	70	2	2+2	0624B10045	0624B100R1	0624B100R3	0624B100R5

**Ricambi / Spare parts / Rechanges / Repuestos / Ersatzteile**

COD.	COD.	COD.	COD.	COD.	COD.	COD.	COD.	COD.
0480050060	0480505600	048060C000	0480700612	0480700620	048074B515	048074C516		
COD.	COD.	COD.	COD.					
K480110000	K480130000	K480150000	K48015R500					
COD.	COD.	COD.	COD.	COD.	COD.			
K480120000	K480140000	K480160000	K48016R500	K48062E000 (45°-R1.5-R3)	K48062ER50 (R5)			
COD.	COD.	COD.	COD.	COD.	COD.	COD.	COD.	COD.
K480120000	K480140000	K480160000	K48016R500	0480783000	048078T200			

Jointing cutter head with edge breakers on tool holder HSK63F.

Cabezal para cantear con mata - cantos y mandril HSK63F.

Porte - outil à détourer avec brise - aretes complet d'arbre HSK63F.

Fügemeserkopf mit Kantenbrechern und Fräsdorn HSK63F.

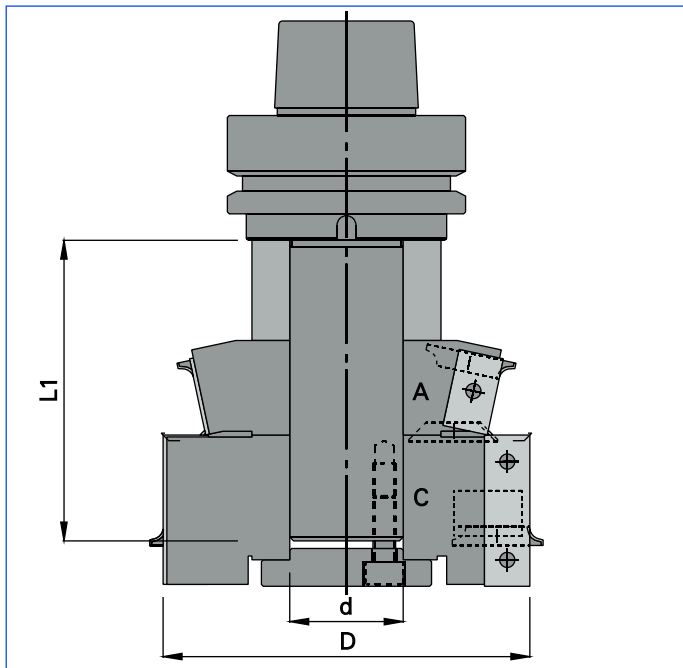

**HW**







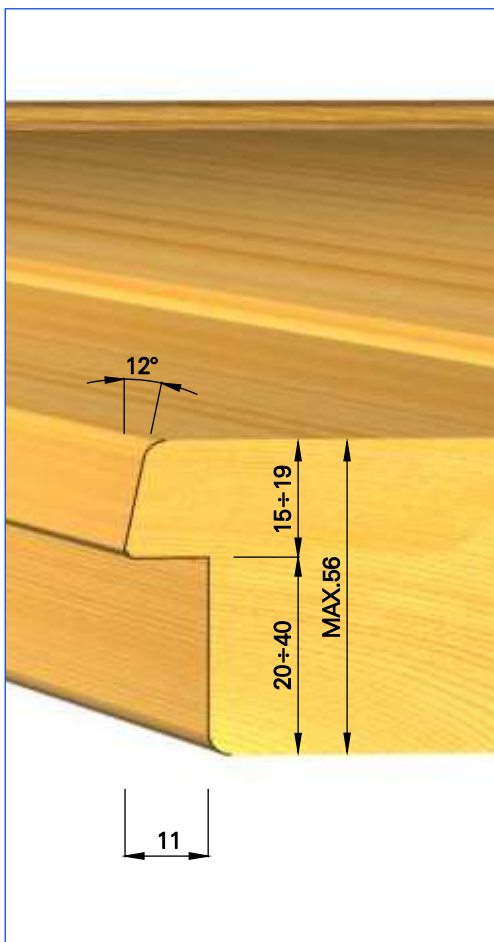





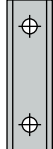

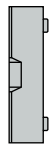

**MEC**

n max 11400

D	d	L1	Z	V	45° COD.	R 1.5 COD.	R 3 COD.
97	30	80	2	2	0623060045	06230600R1	06230600R3

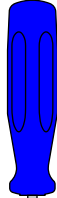

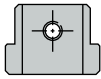
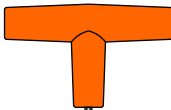
**Ricambi / Spare parts / Rechanges / Repuestos / Ersatzteile**

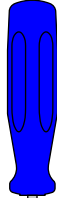
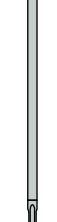
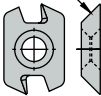
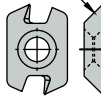
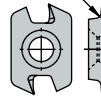
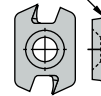
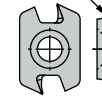
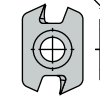
					
COD.	COD.	COD.	COD.	COD.	COD.
0480030014	0480050020	0480050040	0480501800	0480503600	048060C000
					
COD.	COD.	COD.	COD.	COD.	COD.
0480700612	0480700620	048074A510	048074B515		
					
COD.	COD.	COD.	COD.	COD.	COD.
048074P350	K48062E000	0480783000	048078T15E	048078T200	
					
COD.	COD.	COD.	COD.	COD.	COD.
K480110000	K480120000	K480130000	K480140000	K480150000	K480160000

 Cutter head set on tool holder HSK63F for door profiling.

 Juego de cabezales completo de mandril HSK63F para perfilar puertas.

 Jeu de porte - outils pour calibrage de portes complet d'arbre HSK63F.

 Messerkopfsatz mit Fräsdorn HSK63F für Türenaussenprofil.

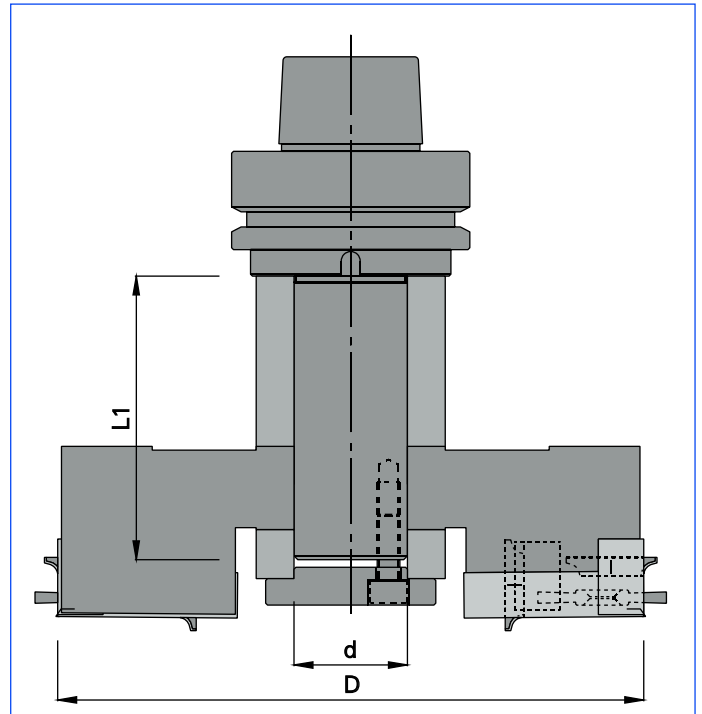

**HW**







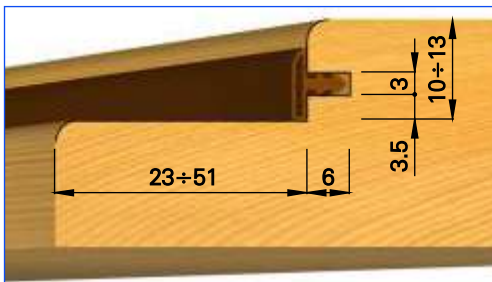



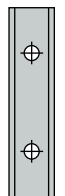

**MEC**

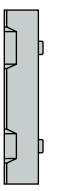
n max 6700

D	d	L1	Z	V	COD.
155	30	50	2+2	2	0623D00000

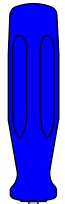

**Ricambi / Spare parts / Rechanges / Repuestos / Ersatzteile**

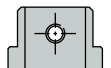
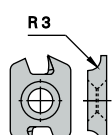
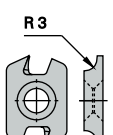
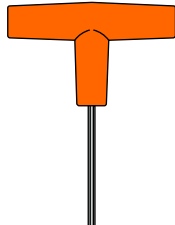
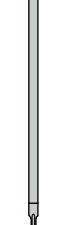
								
COD.	COD.	COD.	COD.	COD.	COD.	COD.	COD.	
0480030014	0480050020	0480050050	0480501800	0480504600	048060C000	0480700612	0480705620	
								
COD.	COD.	COD.	COD.	COD.	COD.	COD.	COD.	COD.
048019A000	048074A510	048074B515	048074C515	K48062E000	K480150000	K480160000	0480783000	048078T200

 Cutter head for door - frame.

 Cabezal para el marco de puertas.

 Porte - outil pour le chassis des portes.

 Türdichtung - Messerkopf.

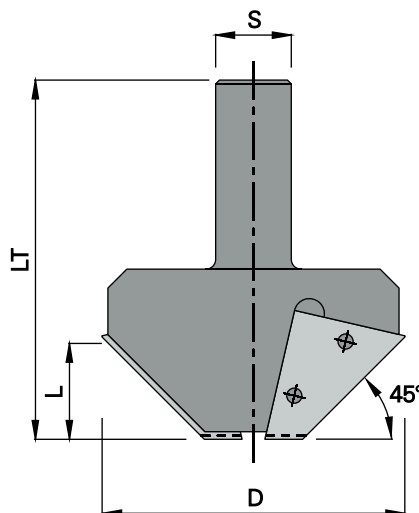

**HW**

**MEC**

n max 12000

D	L	LT	S	Z	COD.
80	25	95	20	2	0628Z00000

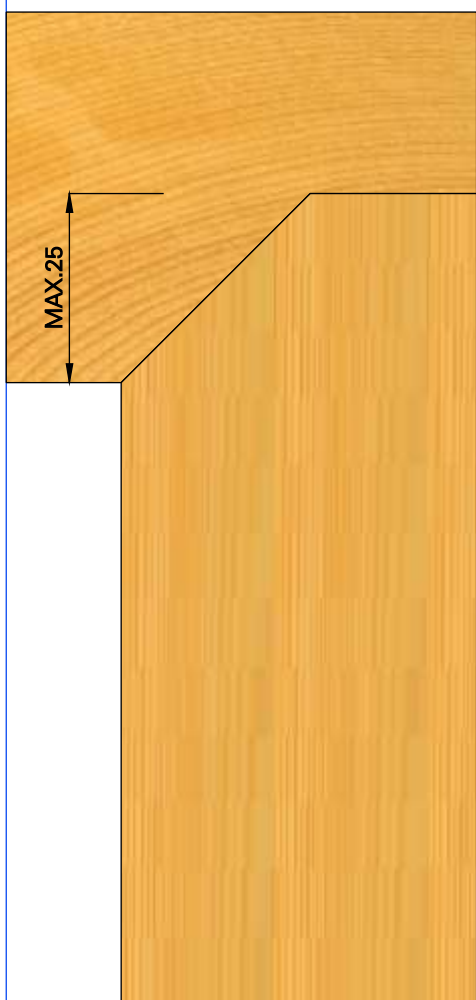

**Ricambi / Spare parts / Rechanges / Repuestos / Ersatzteile**

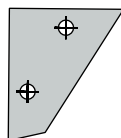

COD.

048128Z000



COD.

048074P460

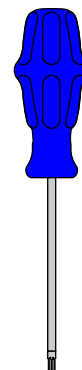

COD.

048078T15E

 Router cutter with profiled knives for door - frame jointing.

 Fresa router con cuchillas para ensamblar marcos de puertas.

 Fraise avec plaquettes à jeter pour abouter le châssis des portes.

 Profilmesser - Oberfräser für Tür - Rahmenverbindung.



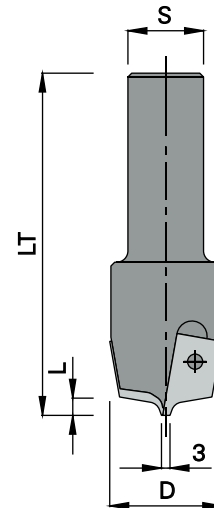

**HW**

**MEC**

n max 20000

D	L	LT	S	Z	COD.
29	5	90	20	2	0631F00000

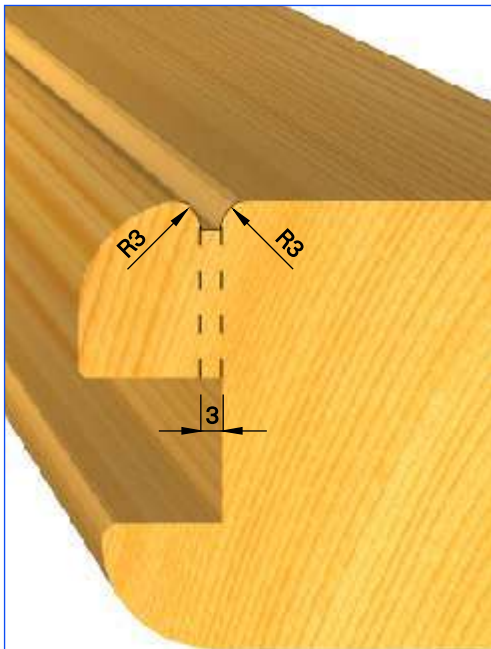

**Ricambi / Spare parts / Rechanges / Repuestos / Ersatzteile**

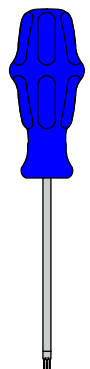

COD.

COD.

COD.

048131F000

048074P350

048078T15E

Router cutter with profiled knives for glass - slip rounding.

Fresa router con cuchillas para redondear el junquillo.

Fraise avec plaquettes à jeter pour arrondir la parclose.



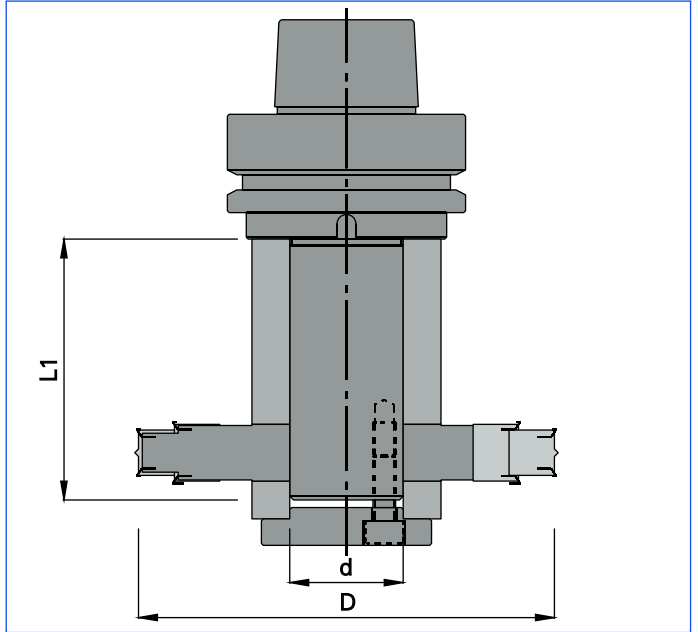



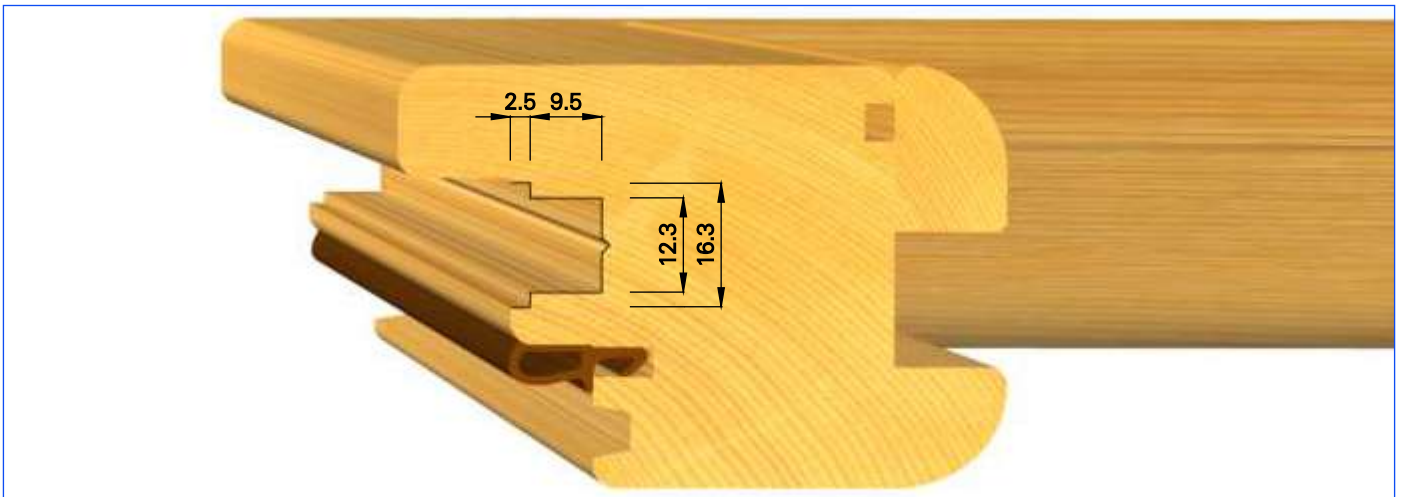



Profilmesser - Oberfräser zum Abrunden von Glass - Leisten.



<b>HW</b>	<b>MEC</b>	D	d	L1	Z	V	COD.
n max 10400		110	30	85	2+2	4 + 4	0643B00000

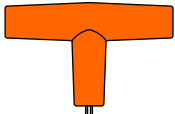
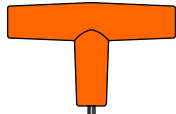

**Ricambi / Spare parts / Rechanges / Repuestos / Ersatzteile**

						
COD. 0480030014	COD. K480430000	COD. 0480050015	COD. 0480501000	COD. 0480501300	COD. 048060B000	COD. 048060C000
						
COD. 0480700512	COD. 0480700612	COD. 048074A510	COD. 0480782500	COD. 0480783000		

 Grooving head for hardware on tool holder HSK63F.

 Cabezal para ranura de falleba completo de mandril HSK63F.

 Porte - outil pour cremone complet d'arbre HSK63F.

 Messerkopf für Beschlagnut mit Fräsdorn HSK63F.

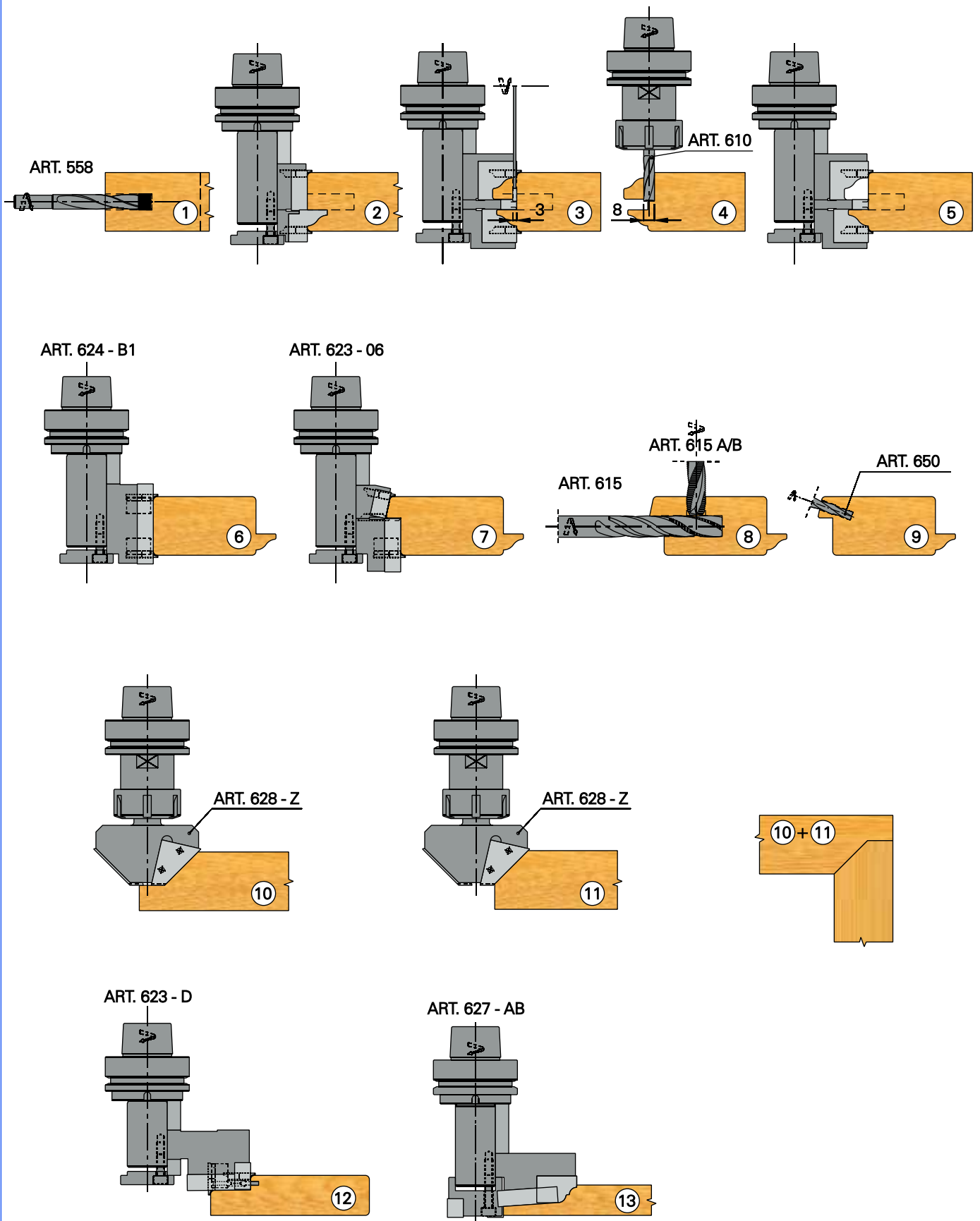

Tools for door and door - frame production.



Herramientas para fabricar puertas y marcos.



Outils pour production de portes et de chassis.



Werkzeuge zur Herstellung von Türen und Rahmen.



ART. 628 - A/RH

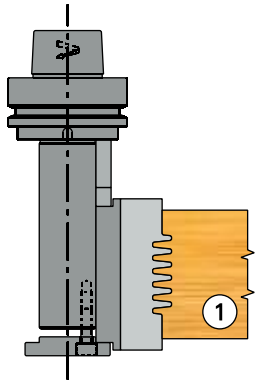

ART. 628 - A/LH

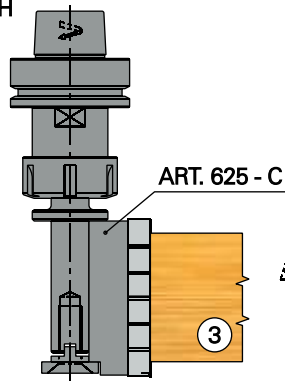
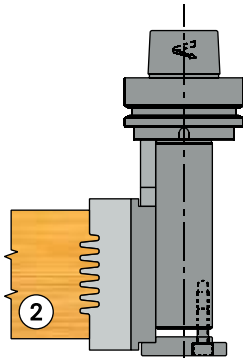

ART. 558

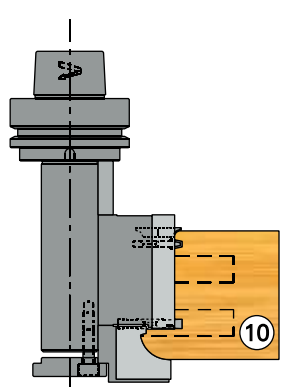
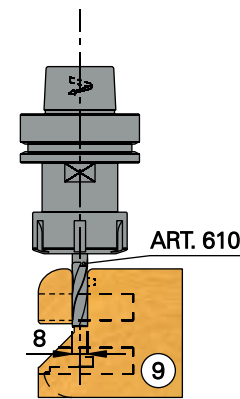
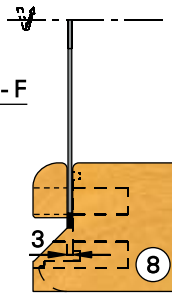
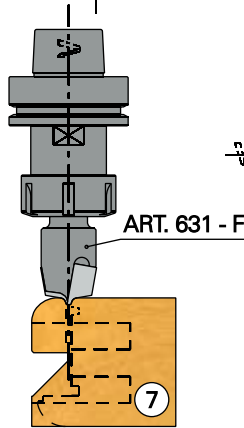
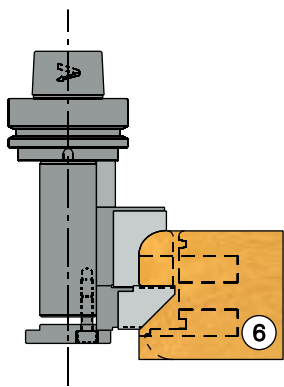
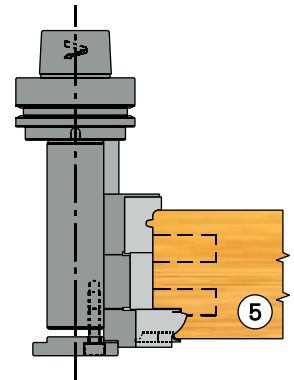
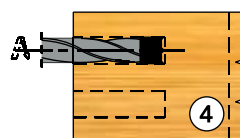

ART. 643 - B

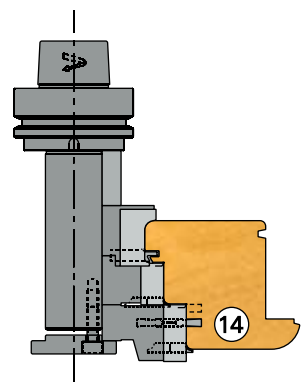
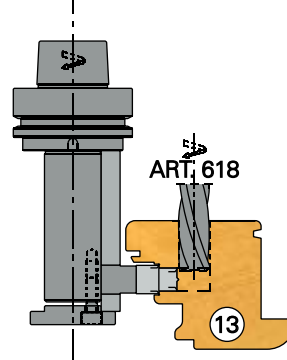
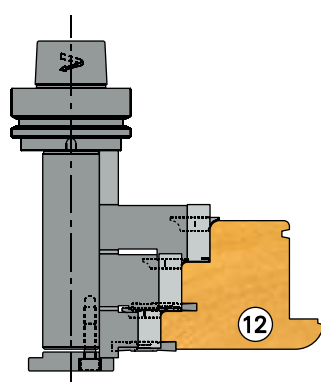
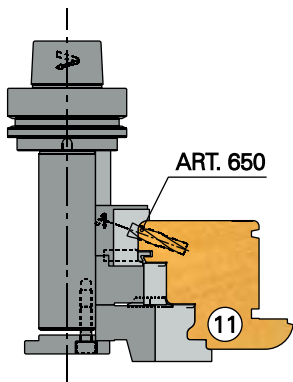

ART. 558

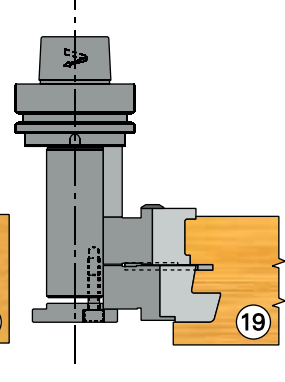
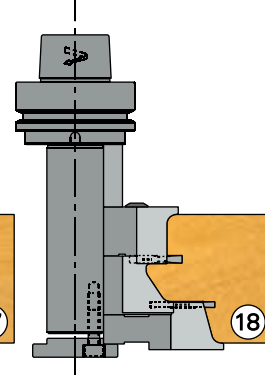
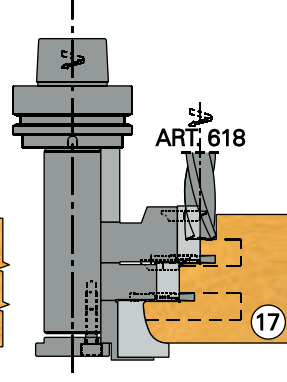
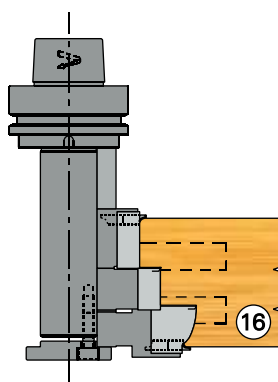
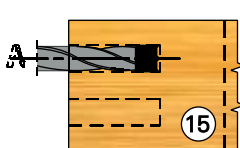

 Tools for production of window sash and frame.

 Herramientas para fabricar ventanas y marcos.

 Outils pour production de fenêtres.

 Werkzeuge zur Herstellung von Fenstern.



DP Tools

Outils en DP

Herramientas de DP

DP Werkzeuge



ART. P326 - P327

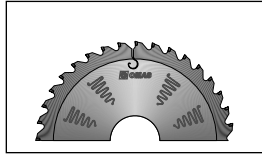

7.2

ART. P334 - P335

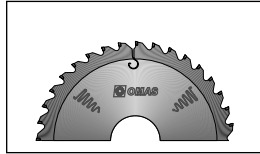

7.3

ART. P336 - P337

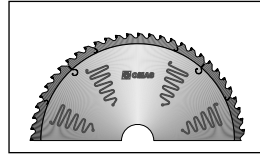

7.4

ART. P338 - P339

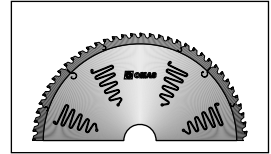

7.5



ART. P341 - P342

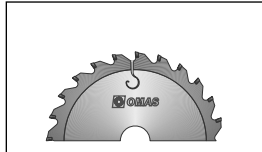

7.6

ART. P343

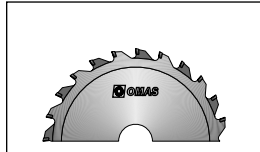

7.7



ART. P353 - P354

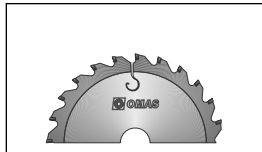

7.8

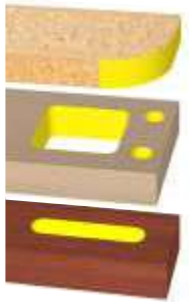

ART. P506



7.9

ART. P511



7.11

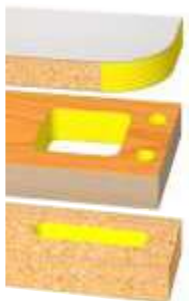

ART. P508



7.10

ART. P514



7.12

ART. P516



7.13

ART. P518



7.14



ART. P556



7.15



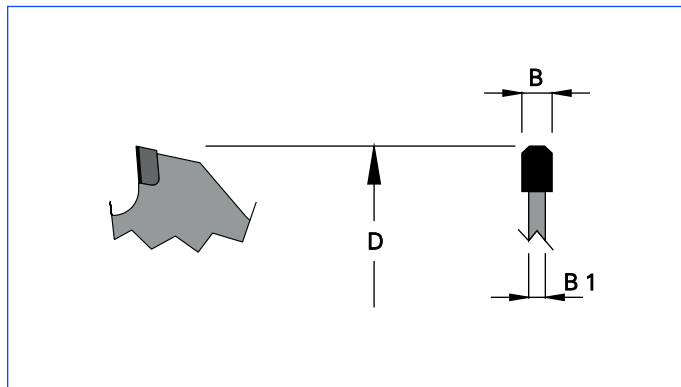
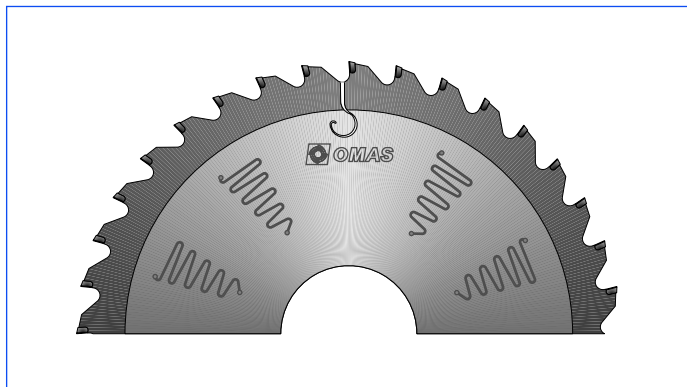

**DP**

– dente trapezoidale



D	B	B1	d	Z	COD.	COD.
200	3,2	2,2	30	24	P326203024	P327203024
200	3,2	2,2	30	36	P326203036	P327203036
200	3,2	2,2	30	48	P326203048	P327203048
250	3,2	2,2	30	36	P326253036	P327253036
250	3,2	2,2	30	48	P326253048	P327253048
250	3,2	2,2	30	60	P326253060	P327253060
300	3,2	2,2	30	48	P326303048	P327303048
300	3,2	2,2	30	60	P326303060	P327303060
300	3,2	2,2	30	72	P326303072	P327303072
300	3,2	2,2	30	84	P326303084	P327303084
350	3,5	2,5	30	54	P326353054	P327353054
350	3,5	2,5	30	72	P326353072	P327353072
350	3,5	2,5	30	84	P326353084	P327353084
350	3,5	2,5	30	96	P326353096	P327353096
400	4,0	2,8	30	60	P326403060	P327403060
400	4,0	2,8	30	72	P326403072	P327403072
400	4,0	2,8	30	84	P326403084	P327403084
400	4,0	2,8	30	96	P326403096	P327403096



Universal DP circular saw blade.



Disco de sierra universal de DP.



Lame circulaire universelle en DP.



Universal DP Kreissägeblatt.

# P334 P335



## Lama per sezionatrici - sgrossatura -

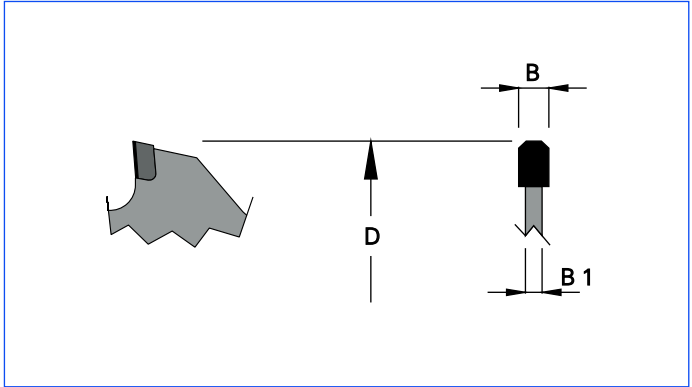
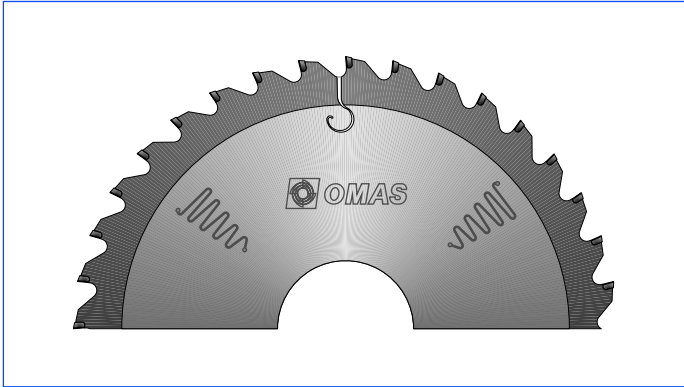

**DP**

– dente trapezoidale

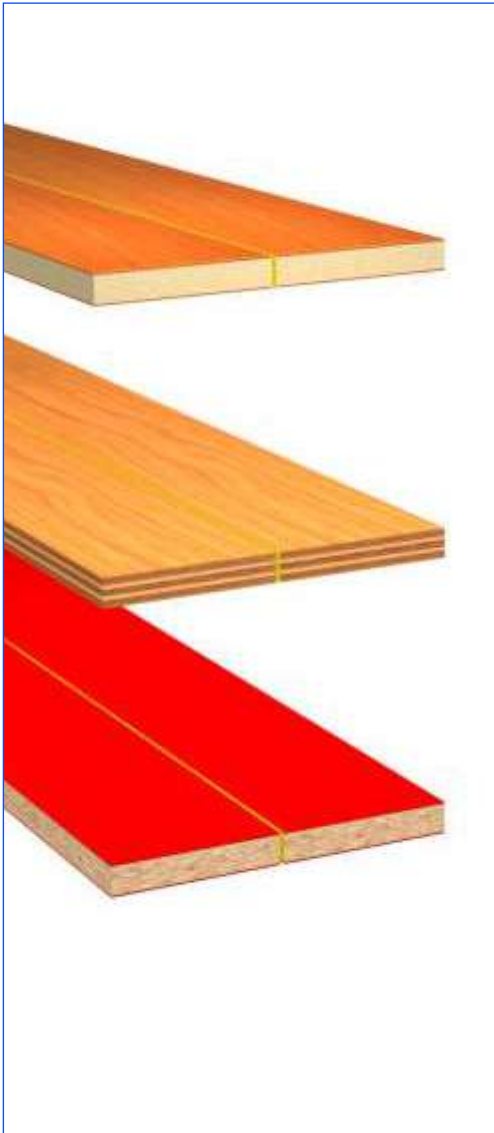

D	B	B1	d	Z	COD.	COD.
300	4,4	3,2	30	36	P334303036	P335303036
300	4,4	3,2	75	36	P334307536	P335307536
300	4,4	3,2	80	36	P334308036	P335308036
350	4,4	3,2	30	36	P334353036	P335353036
350	4,4	3,2	75	36	P334357536	P335357536
350	4,4	3,2	80	36	P334358036	P335358036
380	4,4	3,2	30	48	P334383048	P335383048
380	4,4	3,2	75	48	P334387548	P335387548
380	4,4	3,2	80	48	P334388048	P335388048
400	4,6	3,5	30	48	P334403048	P335403048
400	4,6	3,5	75	48	P334407548	P335407548
400	4,6	3,5	80	48	P334408048	P335408048
420	4,6	3,5	30	48	P334423048	P335423048
420	4,6	3,5	75	48	P334427548	P335427548
420	4,6	3,5	80	48	P334428048	P335428048
430	4,6	3,5	30	48	P334433048	P335433048
430	4,6	3,5	75	48	P334437548	P335437548
430	4,6	3,5	80	48	P334438048	P335438048
450	4,6	3,5	30	44	P334453044	P335453044
450	4,6	3,5	75	44	P334457544	P335457544
450	4,6	3,5	80	44	P334458044	P335458044
465	4,6	3,5	30	48	P334463048	P335463048
465	4,6	3,5	75	48	P334467548	P335467548
465	4,6	3,5	80	48	P334468048	P335468048
470	4,6	3,5	30	54	P334473054	P335473054
470	4,6	3,5	75	54	P334477554	P335477554
470	4,6	3,5	80	54	P334478054	P335478054
480	4,6	3,5	30	48	P334483048	P335483048
480	4,6	3,5	75	48	P334487548	P335487548
480	4,6	3,5	80	48	P334488048	P335488048
500	5,2	4,0	30	48	P334503048	P335503048
500	5,2	4,0	75	48	P334507548	P335507548
500	5,2	4,0	80	48	P334508048	P335508048
570	5,2	4,0	30	48	P334573048	P335573048
570	5,2	4,0	75	48	P334577548	P335577548
570	5,2	4,0	80	48	P334578048	P335578048
600	5,2	4,0	30	48	P334603048	P335603048
600	5,2	4,0	75	48	P334607548	P335607548
600	5,2	4,0	80	48	P334608048	P335608048

DP saw blade for panel sizing machine.  
( Roughing ).

Disco de sierra para seccionadora de DP.  
( Desbaste ).

Lame circulaire pour scie à panneaux en DP.  
( Dégrossage ).

DP Keissägeblatt für Plattenquerteilmaschinen  
( Große Feinbearbeitung ).

# P336 P337



## Lama per sezionatrici - media finitura -

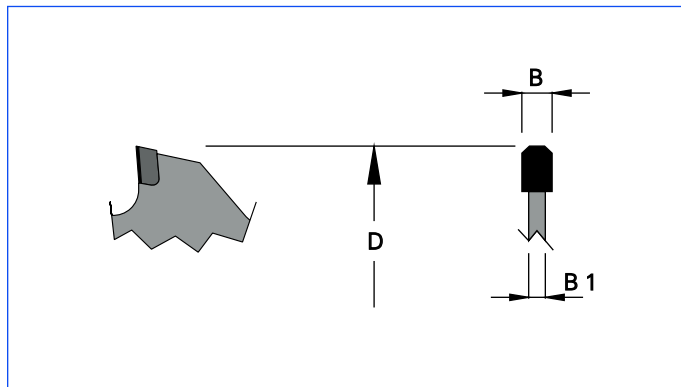
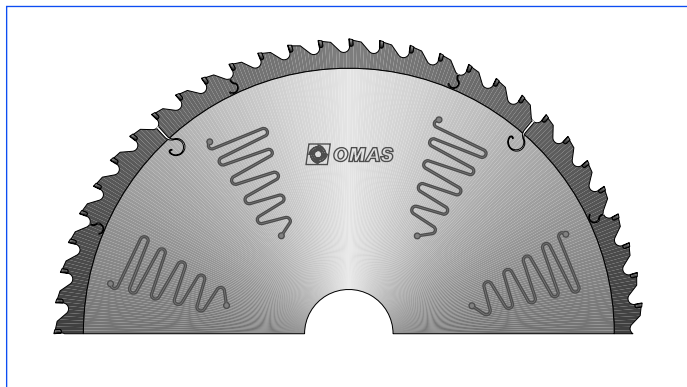

**DP**

- dente trapezoidale

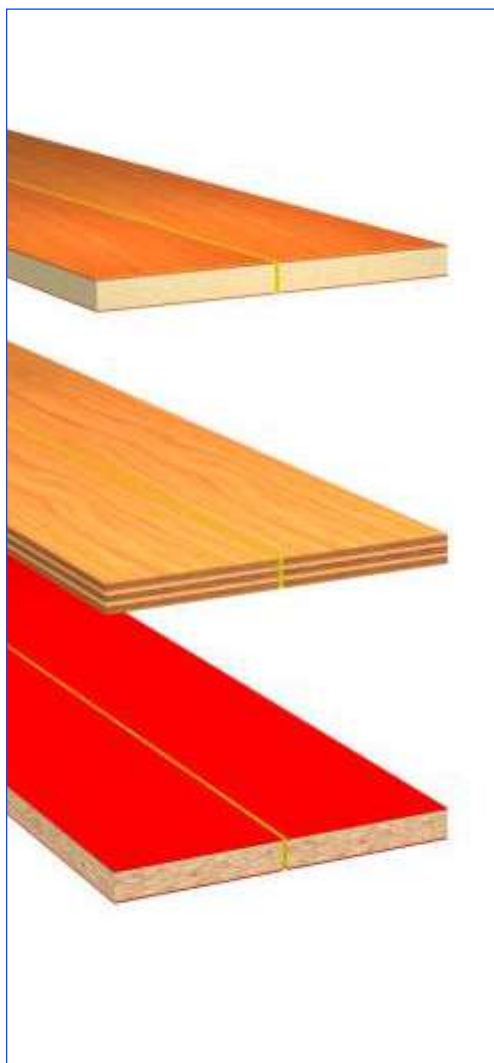

D	B	B1	d	Z	COD.	COD.
300	4,4	3,2	30	60	P336303060	P337303060
300	4,4	3,2	75	60	P336307560	P337307560
300	4,4	3,2	80	60	P336308060	P337308060
350	4,4	3,2	30	60	P336353060	P337353060
350	4,4	3,2	75	60	P336357560	P337357560
350	4,4	3,2	80	60	P336358060	P337358060
380	4,4	3,2	30	60	P336383060	P337383060
380	4,4	3,2	75	60	P336387560	P337387560
380	4,4	3,2	80	60	P336388060	P337388060
400	4,6	3,5	30	60	P336403060	P337403060
400	4,6	3,5	75	60	P336407560	P337407560
400	4,6	3,5	80	60	P336408060	P337408060
420	4,6	3,5	30	64	P336423064	P337423064
420	4,6	3,5	75	64	P336427564	P337427564
420	4,6	3,5	80	64	P336428064	P337428064
430	4,6	3,5	30	64	P336433064	P337433064
430	4,6	3,5	75	64	P336437564	P337437564
430	4,6	3,5	80	64	P336438064	P337438064
450	4,6	3,5	30	64	P336453064	P337453064
450	4,6	3,5	75	64	P336457564	P337457564
450	4,6	3,5	80	64	P336458064	P337458064
465	4,6	3,5	30	64	P336463064	P337463064
465	4,6	3,5	75	64	P336467564	P337467564
465	4,6	3,5	80	64	P336468064	P337468064
470	4,6	3,5	30	64	P336473064	P337473064
470	4,6	3,5	75	64	P336477564	P337477564
470	4,6	3,5	80	64	P336478064	P337478064
480	4,6	3,5	30	64	P336483064	P337483064
480	4,6	3,5	75	64	P336487564	P337487564
480	4,6	3,5	80	64	P336488064	P337488064
500	5,2	4,0	30	64	P336503064	P337503064
500	5,2	4,0	75	64	P336507564	P337507564
500	5,2	4,0	80	64	P336508064	P337508064
570	5,2	4,0	30	64	P336573064	P337573064
570	5,2	4,0	75	64	P336577564	P337577564
570	5,2	4,0	80	64	P336578064	P337578064
600	5,2	4,0	30	64	P336603064	P337603064
600	5,2	4,0	75	64	P336607564	P337607564
600	5,2	4,0	80	64	P336608064	P337608064



DP saw blade for panel sizing machine.  
( Medium finishing ).



Disco de sierra de DP para seccionadora.  
( Acabado medio ).



Lame circulaire en DP pour scie à panneaux .  
( Moyenne finition ).



DP Kreissägeblatt für Plattenaufteilmaschinen.  
( Mittelfinbearbeitung ).



# P338 P339



## Lama per sezionatrici - buona finitura -

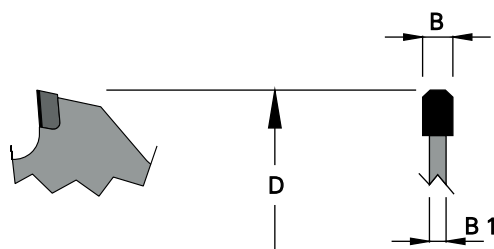
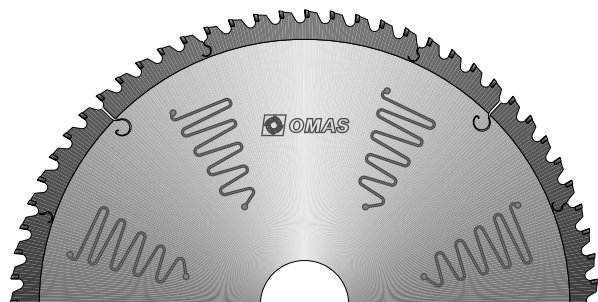

**DP**

- dente trapezoidale



D	B	B1	d	Z	COD.	COD.
300	4,4	3,2	30	72	P338303072	P339303072
300	4,4	3,2	75	72	P338307572	P339307572
300	4,4	3,2	80	72	P338308072	P339308072
350	4,4	3,2	30	72	P338353072	P339353072
350	4,4	3,2	75	72	P338357572	P339357572
350	4,4	3,2	80	72	P338358072	P339358072
380	4,4	3,2	30	72	P338383072	P339383072
380	4,4	3,2	75	72	P338387572	P339387572
380	4,4	3,2	80	72	P338388072	P339388072
400	4,6	3,5	30	72	P338403072	P339403072
400	4,6	3,5	75	72	P338407572	P339407572
400	4,6	3,5	80	72	P338408072	P339408072
420	4,6	3,5	30	72	P338423072	P339423072
420	4,6	3,5	75	72	P338427572	P339427572
420	4,6	3,5	80	72	P338428072	P339428072
430	4,6	3,5	30	72	P338433072	P339433072
430	4,6	3,5	75	72	P338437572	P339437572
430	4,6	3,5	80	72	P338438072	P339438072
450	4,6	3,5	30	72	P338453072	P339453072
450	4,6	3,5	75	72	P338457572	P339457572
450	4,6	3,5	80	72	P338458072	P339458072
465	4,6	3,5	30	72	P338463072	P339463072
465	4,6	3,5	75	72	P338467572	P339467572
465	4,6	3,5	80	72	P338468072	P339468072
470	4,6	3,5	30	72	P338473072	P339473072
470	4,6	3,5	75	72	P338477572	P339477572
470	4,6	3,5	80	72	P338478072	P339478072
480	4,6	3,5	30	72	P338483072	P339483072
480	4,6	3,5	75	72	P338487572	P339487572
480	4,6	3,5	80	72	P338488072	P339488072
500	5,2	4,0	30	72	P338503072	P339503072
500	5,2	4,0	75	72	P338507572	P339507572
500	5,2	4,0	80	72	P338508072	P339508072
570	5,2	4,0	30	72	P338573072	P339573072
570	5,2	4,0	75	72	P338577572	P339577572
570	5,2	4,0	80	72	P338578072	P339578072
600	5,2	4,0	30	72	P338603072	P339603072
600	5,2	4,0	75	72	P338607572	P339607572
600	5,2	4,0	80	72	P338608072	P339608072



DP saw blade for panel sizing machine.  
( Good finishing ).



Disco de sierra de DP para seccionadora.  
( Acabado bueno ).



Lame circulaire en DP pour scie à panneaux .  
( Bonne finition ).



DP Kreissägeblatt für Plattenaufteilmaschinen.  
( Feinbearbeitung ).

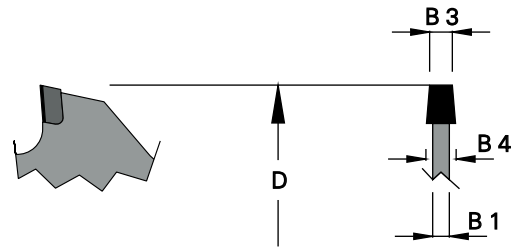

DP

– dente a profilo conico

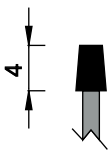
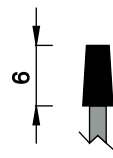

D	B3	B4	B1	d	Z	COD.	COD.
							
120	3.2	3.8	2.2	20	24	P341122024	P342122024
120	3.2	3.8	2.2	30	24	P341123024	P342123024
125	3.2	3.8	2.2	20	24	P341132024	P342132024
125	3.2	3.8	2.2	30	24	P341133024	P342133024
125	4.4	5	2.8	50	24	P341135024	P342135024
125	4.4	5	2.8	55	24	P341135524	P342135524
125	4.4	5	2.8	65	24	P341136524	P342136524
150	4.4	5	2.8	50	24	P341155024	P342155024
150	4.4	5	2.8	55	24	P341155524	P342155524
150	4.4	5	2.8	65	24	P341156524	P342156524
160	4.4	5	2.8	50	24	P341165024	P342165024
160	4.4	5	2.8	55	24	P341165524	P342165524
160	4.4	5	2.8	65	24	P341166524	P342166524
180	4.4	5	2.8	50	30	P341185030	P342185030
180	4.4	5	2.8	55	30	P341185530	P342185530
180	4.4	5	2.8	65	30	P341186530	P342186530
200	4.4	5	2.8	50	30	P341205030	P342205030
200	4.4	5	2.8	55	30	P341205530	P342205530
200	4.4	5	2.8	65	30	P341206530	P342206530
270	4.4	5	2.8	50	36	P341275036	P342275036
270	4.4	5	2.8	55	36	P341275536	P342275536
270	4.4	5	2.8	65	36	P341276536	P342276536
300	4.4	5	2.8	50	48	P341305048	P342305048
300	4.4	5	2.8	55	48	P341305548	P342305548
300	4.4	5	2.8	65	48	P341306548	P342306548

 DP conical scoring blade.

 Sierra incisora cónica de DP.

 Lame incisiveuse conique en DP.

 DP Konische Ritz - Kreissägeblatt.

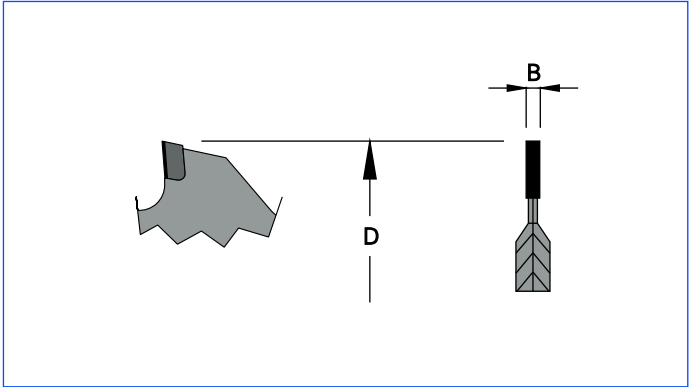



**DP**

– dente piano

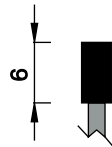

D	B	d	Z	COD.
100	2.8-3.6	20	10+10	P343102010
100	2.8-3.6	22	10+10	P343102210
120	2.8-3.6	20	12+12	P343122012
120	2.8-3.6	22	12+12	P343122212
125	2.8-3.6	20	12+12	P343132012
125	2.8-3.6	30	12+12	P343133012



 DP scoring blade adjustable by spacers.

 Sierra incisora de DP ajustable con anillos.

 Lame inciseuse en DP extensible par bagues.

 DP verstellbar Ritz - Kreissägeblatt.

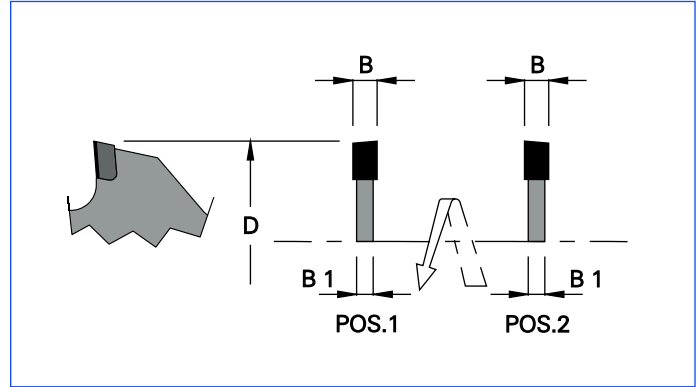

**DP**

– denti inclinati da una sola parte.

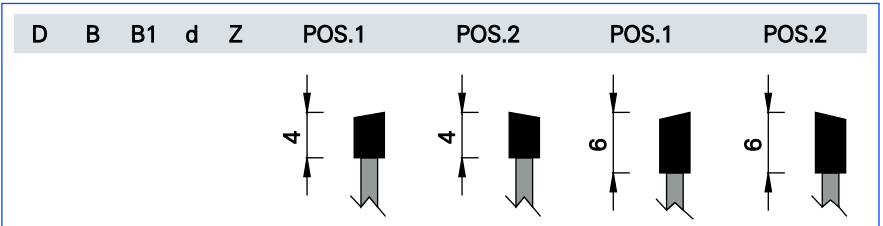

150	3,2	2,2	55	24	P353155521	P353155522	P354155521	P354155522
150	3,2	2,2	60	24	P353156021	P353156022	P354156021	P354156022
150	3,2	2,2	55	30	P353155531	P353155532	P354155531	P354155532
150	3,2	2,2	60	30	P353156031	P353156032	P354156031	P354156032
180	3,2	2,2	55	30	P353185531	P353185532	P354185531	P354185532
180	3,2	2,2	60	30	P353186031	P353186032	P354186031	P354186032
200	3,2	2,2	55	36	P353205531	P353205532	P354205531	P354205532
200	3,2	2,2	60	36	P353206031	P353206032	P354206031	P354206032
200	3,2	2,2	55	48	P353205541	P353205542	P354205541	P354205542
200	3,2	2,2	60	48	P353206041	P353206042	P354206041	P354206042

DP scoring saw blade with one side bevel tooth.

Sierra incisora de DP con diente bisel unilateral.

Lame inciseuse en DP avec denture biaisée unilatérale.

DP Ritz mit einseitig Schrägzahw.

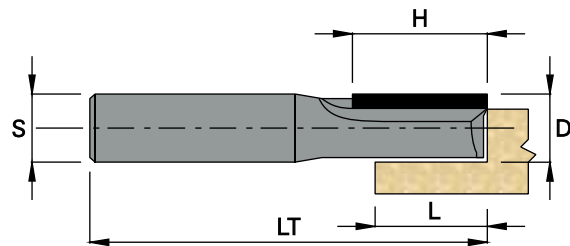

**DP**

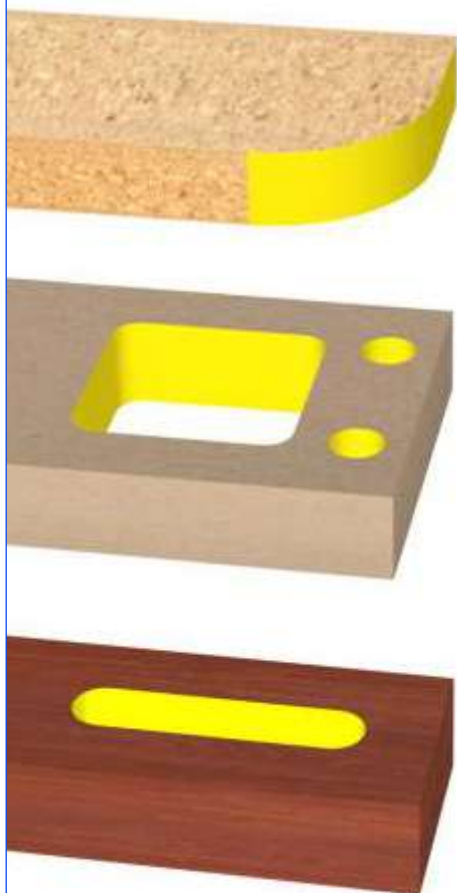

D	H	L	LT	Z	S	COD.RH	COD.LH
6	8	6	55	1	12x35	P5060606R0	P5060606L0
8	12	10	60	1	12x35	P5060810R0	P5060810L0
10	22	20	65	1+1	12x35	P5061020R0	P5061020L0
12	26	24	70	1	12x35	P5061224R0	P5061224L0
12	36	34	80	1	12x35	P5061234R0	P5061234L0
16	26	24	90	1	16x50	P5061624R0	P5061624L0
16	36	34	100	1	16x50	P5061634R0	P5061634L0
18	26	24	85	1	20x50	P5061824R0	P5061824L0
18	36	34	95	1	20x50	P5061834R0	P5061834L0
18	45	43	105	1	20x50	P5061843R0	P5061843L0
20	26	24	85	1	20x50	P5062024R0	P5062024L0
20	36	34	95	1	20x50	P5062034R0	P5062034L0
20	45	43	105	1	20x50	P5062043R0	P5062043L0



DP router cutter with straight cut.



Fresa para fresadora de DP con corte recto.



Fraise pour defonçeuse á coupes droites en DP



DP Oberfräser mit gerade Schneide.

# P508



## Punta usa e getta - 1 tagliente per punto

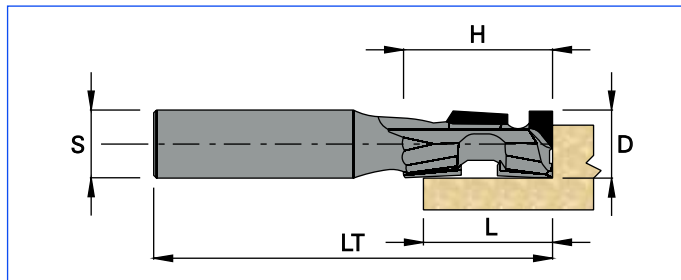
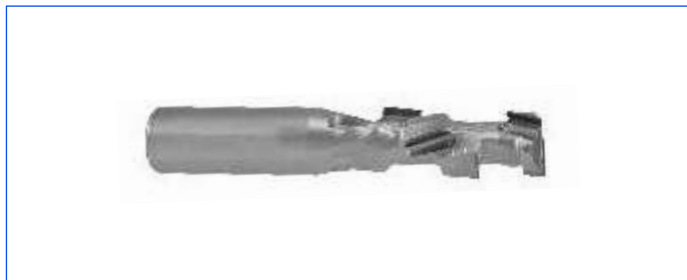

**DP**

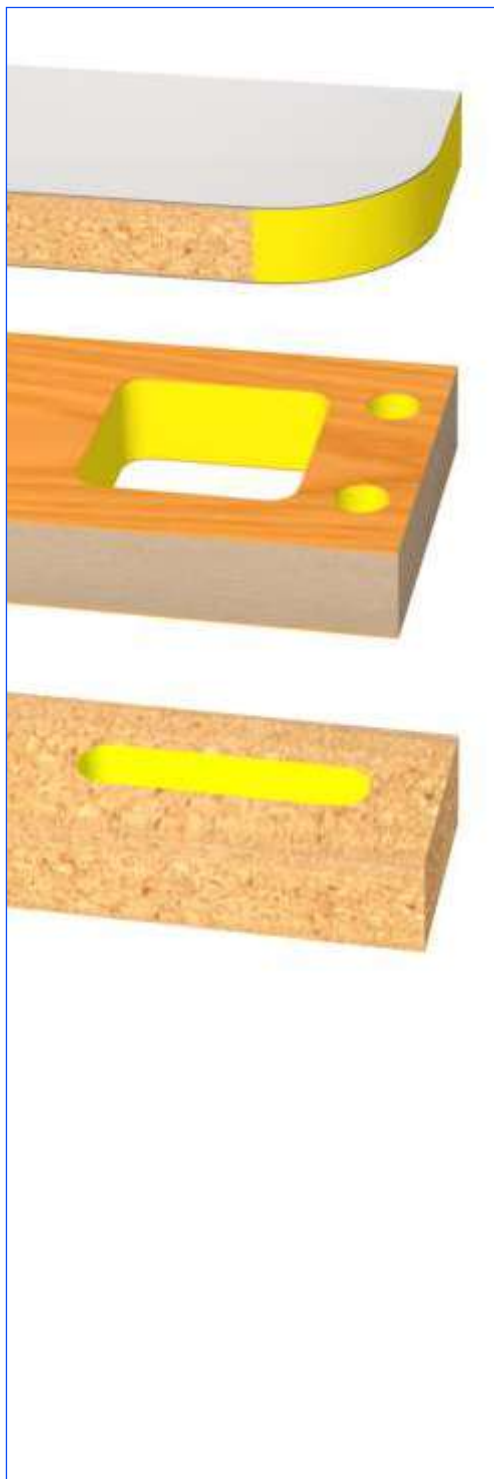

D	H	L	LT	Z	Placc. Tips	S	COD. RH	COD. LH
10	27	23	70	2	3+1HW	12X35	P5081023R0	P5081023L0
10	36	32	80	2	4+1HW	12X35	P5081032R0	P5081032L0
12	27	23	70	2	3+1HW	12X35	P5081223R0	P5081223L0
12	36	32	80	2	4+1HW	12X35	P5081232R0	P5081232L0
12,7	27	23	70	2	3+1HW	12,7x35	P5081323R0	P5081323L0
12,7	36	32	80	2	4+1HW	12,7x35	P5081332R0	P5081332L0
16	27	23	90	2	3+1HW	16x50	P5081623R0	P5081623L0
16	36	32	95	2	4+1HW	16x45	P5081632R0	P5081632L0
18	27	23	80	2	3+1HW	16x45	P5081823R0	P5081823L0
18	36	32	90	2	4+1HW	16x45	P5081832R0	P5081832L0
18	45	41	95	2	5+1HW	16x45	P5081841R0	P5081841L0
20	27	23	85	3	3+1HW	20x50	P5082023R0	P5082023L0
20	36	32	95	3	4+1HW	20x50	P5082032R0	P5082032L0
20	45	41	105	3	5+1HW	20x50	P5082041R0	P5082041L0
20	50	46	105	2	6+1HW	20x50	P5082046R0	P5082046L0
20	54	51	115	3	6+1HW	20x50	P5082051R0	P5082051L0
20	70	66	132	3	8+1HW	20x50	P5082066R0	P5082066L0
20	80	76	141	3	9+1HW	20x50	P5082076R0	P5082076L0

Economic router bit - 1 cutting edge for point.

Broca económica de DP con 1 corte cada punto.

Mèche économique en DP avec 1 tranchant pour point.

DP wirtschaftsbohrer mit 1 Schlitz fede Punkt.

# P511



## Punta usa e getta - 2 taglienti per punto

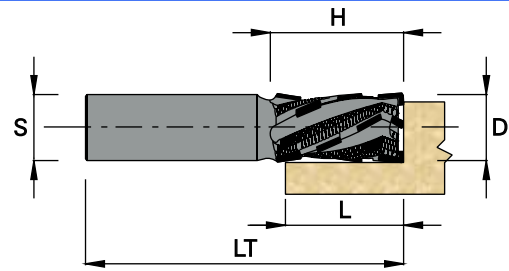

**DP**

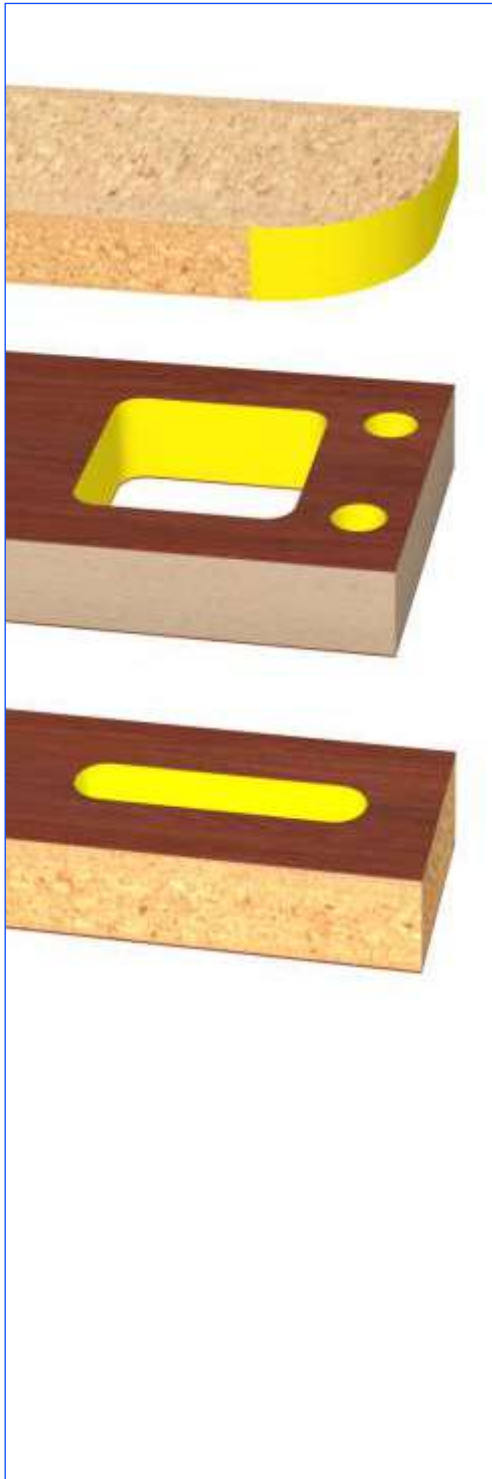

D	H	L	LT	Z	Placc. Tips	S	COD. RH	COD. LH
16	27	23	87	2+2	6+1HW	20x50	P5111623R0	P5111623L0
16	36	32	96	2+2	8+1HW	20x50	P5111632R0	P5111632L0
18	27	23	87	2+2	6+1HW	20x50	P5111823R0	P5111823L0
18	36	32	96	2+2	8+1HW	20x50	P5111832R0	P5111832L0
18	45	41	106	2+2	10+1HW	20x50	P5111841R0	P5111841L0
20	27	23	87	2+2	6+1HW	20x50	P5112023R0	P5112023L0
20	38	34	98	2+2	8+1HW	20x50	P5112034R0	P5112034L0
20	45	41	106	2+2	10+1HW	20x50	P5112041R0	P5112041L0
20	54	50	115	2+2	12+1HW	20x50	P5112050R0	P5112050L0
20	63	59	124	2+2	14+1HW	20x50	P5112059R0	P5112059L0

 Economic router bit - 2 cutting edges for point.

 Broca económica de DP con 2 cortes cada punto.

 Mèche économique en DP avec 2 tranchants pour point.

 DP wirtschaftsbohrer mit 2 Schneidew federe Punkt.

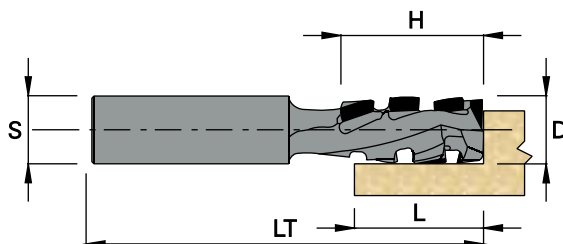

**DP**

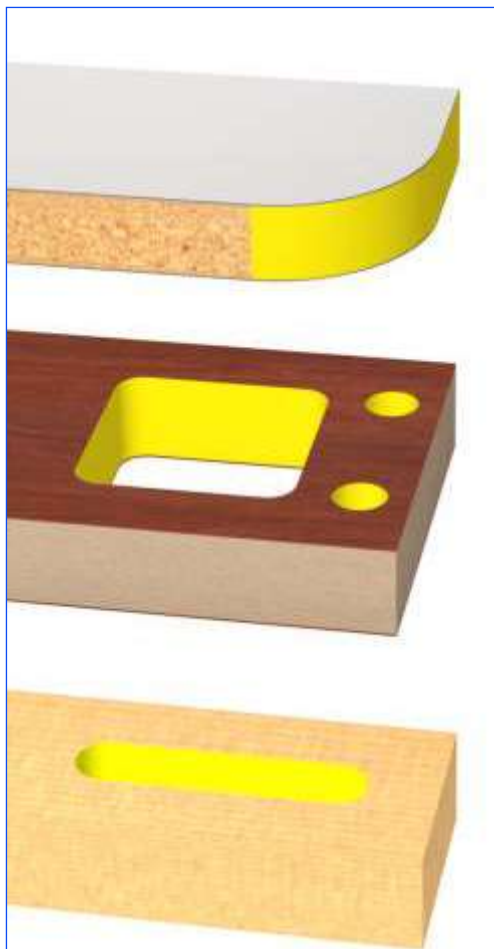

D	H	L	LT	Z	Placc. Tips	S	COD. RH	COD. LH
20	25	21	85	2	3+1HW	20x50	P5142021R2	P5142021L2
20	35	31	96	2	5+1HW	20x50	P5142031R2	P5142031L2
20	46	42	110	2	6+1HW	20x50	P5142042R2	P5142042L2
20	53	49	115	2	7+1HW	20x50	P5142049R2	P5142049L2
22	67	63	123	2	9+1HW	20x50	P5142263R2	P5142263L2
20	25	21	100	2	3+1HW	25x60	P5142021R5	P5142021L5
20	35	31	112	2	5+1HW	25x60	P5142031R5	P5142031L5
20	46	42	120	2	6+1HW	25x60	P5142042R5	P5142042L5
20	53	49	125	2	7+1HW	25x60	P5142049R5	P5142049L5
22	67	63	138	2	9+1HW	25x60	P5142263R5	P5142263L5



DP spiral router bit Z = 2.



Fresa helicoidal de DP Z = 2.



Fraise hélicoidale en DP Z = 2.



DP Spiral - Oberfräser Z = 2.



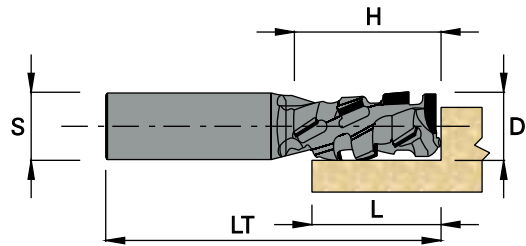

**DP**

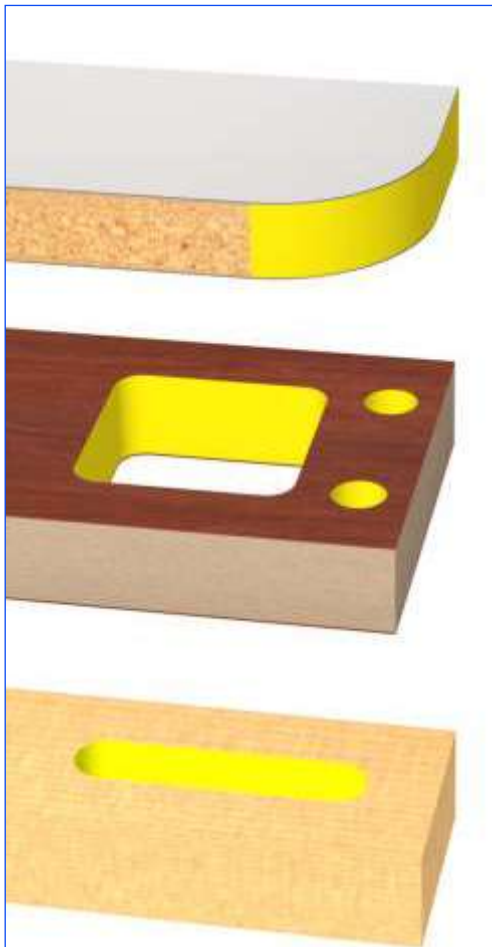

D	H	L	LT	Z	Placc. Tips	S	COD. RH	COD. LH
20	35	30	100	3	6+1HW	20x50	P5162030R2	P5162030L2
20	43	39	105	3	7+1HW	20x50	P5162039R2	P5162039L2
20	49	45	110	3	8+1HW	20x50	P5162045R2	P5162045L2
20	54	50	115	3	9+1HW	20x50	P5162050R2	P5162050L2
22	35	30	100	3	6+1HW	20x50	P5162230R2	P5162230L2
22	43	39	105	3	7+1HW	20x50	P5162239R2	P5162239L2
22	49	45	110	3	8+1HW	20x50	P5162245R2	P5162245L2
22	54	50	115	3	9+1HW	20x50	P5162250R2	P5162250L2
22	60	56	120	3	10+1HW	20x50	P5162256R2	P5162256L2
22	65	61	125	3	11+1HW	20x50	P5162261R2	P5162261L2
22	71	67	130	3	12+1HW	20x50	P5162267R2	P5162267L2
22	76	72	135	3	13+1HW	20x50	P5162272R2	P5162272L2
22	82	78	140	3	14+1HW	20x50	P5162278R2	P5162278L2
20	35	30	110	3	6+1HW	25x60	P5162030R5	P5162030L5
20	43	39	115	3	7+1HW	25x60	P5162039R5	P5162039L5
20	49	45	120	3	8+1HW	25x60	P5162045R5	P5162045L5
20	54	50	125	3	9+1HW	25x60	P5162050R5	P5162050L5
22	35	30	110	3	6+1HW	25x60	P5162230R5	P5162230L5
22	43	39	115	3	7+1HW	25x60	P5162239R5	P5162239L5
22	49	45	120	3	8+1HW	25x60	P5162245R5	P5162245L5
22	54	50	125	3	9+1HW	25x60	P5162250R5	P5162250L5
22	60	56	130	3	10+1HW	25x60	P5162256R5	P5162256L5
22	65	61	135	3	11+1HW	25x60	P5162261R5	P5162261L5
22	71	67	140	3	12+1HW	25x60	P5162267R5	P5162267L5
22	76	72	145	3	13+1HW	25x60	P5162272R5	P5162272L5
22	82	78	150	3	14+1HW	25x60	P5162278R5	P5162278L5

 DP spiral router bit Z = 3.

 Fresa helicoidal de DP Z = 3.

 Fraise hélicoidale en DP Z = 3.

 DP Spiral - Oberfräser Z = 3.

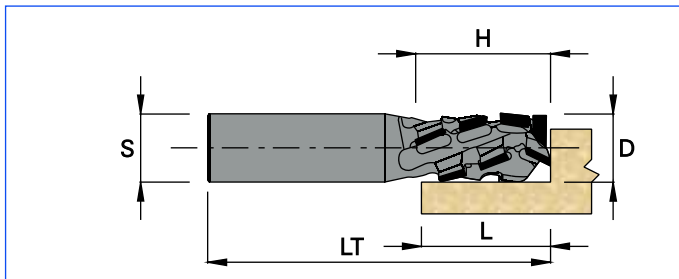
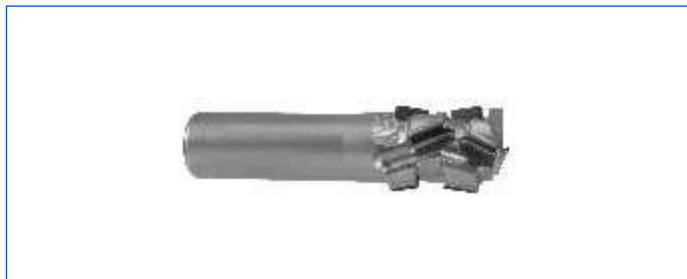

DP

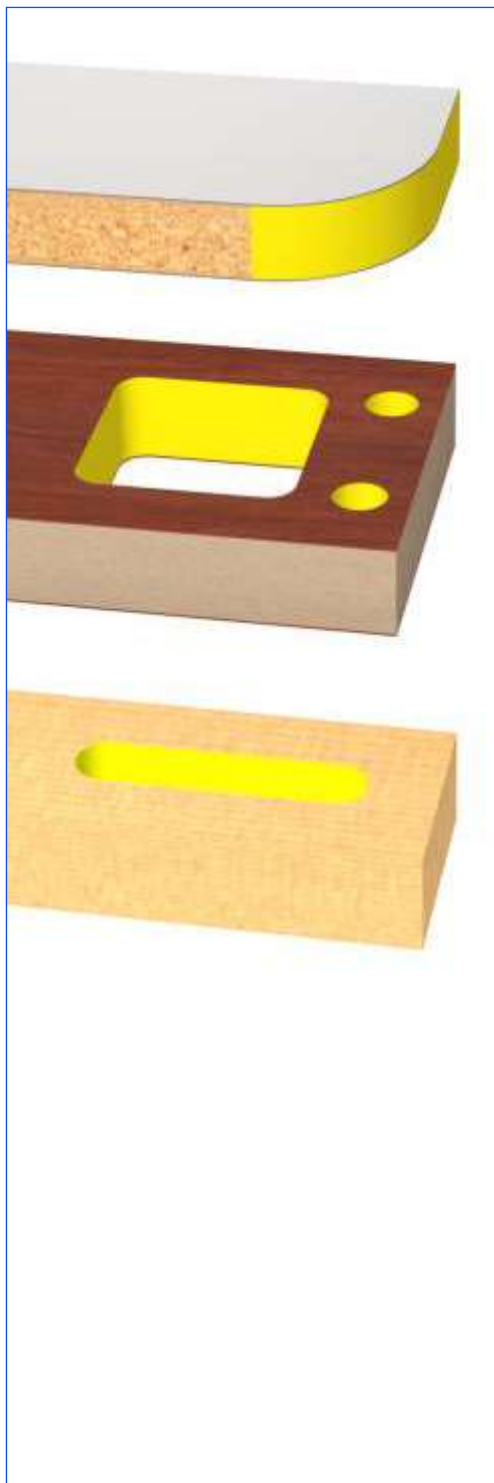

D	H	L	LT	Z	Placc. Tips	S	COD. RH	COD. LH
25	32	28	95	4	8+1HW	20x50	P5182528R2	P5182528L2
25	46	42	110	4	12+1HW	20x50	P5182542R2	P5182542L2
25	32	28	105	4	8+1HW	25x60	P5182528R5	P5182528L5
25	46	42	120	4	12+1HW	25x60	P5182542R5	P5182542L5



DP spiral router bit Z = 4.



Fresa helicoidal de DP Z = 4.



Fraise hélicoidale en DP Z = 4.



DP Spiral - Oberfräser Z = 4.

# P556



## Punta componibile per cerniere

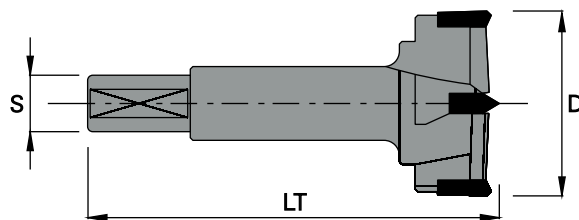

**DP**

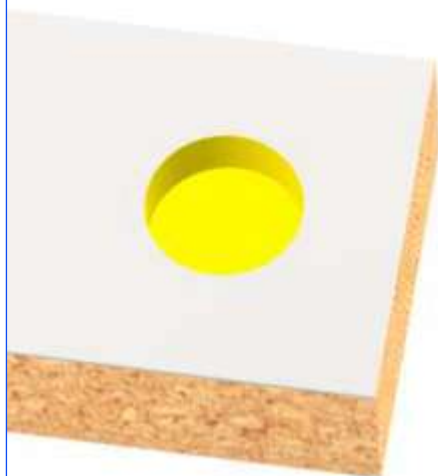
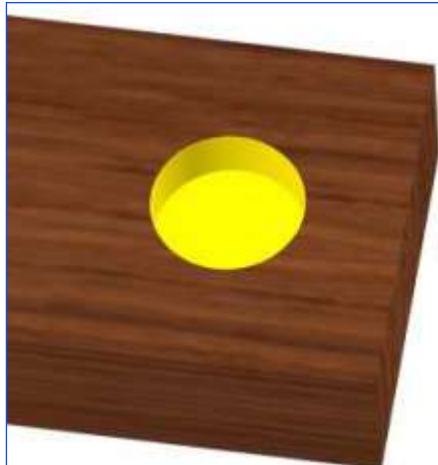

D	LT	S	Z	COD. RH	COD. LH
14	57	10x20	2+2	P5561457R0	P5561457L0
15	57	10x20	2+2	P5561557R0	P5561557L0
16	57	10x20	2+2	P5561657R0	P5561657L0
20	57	10x20	2+2	P5562057R0	P5562057L0
25	57	10x20	2+2	P5562557R0	P5562557L0
26	57	10x20	2+2	P5562657R0	P5562657L0
30	57	10x20	2+2	P5563057R0	P5563057L0
35	57	10x20	2+2	P5563557R0	P5563557L0
14	70	10x20	2+2	P5561470R0	P5561470L0
15	70	10x20	2+2	P5561570R0	P5561570L0
16	70	10x20	2+2	P5561670R0	P5561670L0
20	70	10x20	2+2	P5562070R0	P5562070L0
25	70	10x20	2+2	P5562570R0	P5562570L0
26	70	10x20	2+2	P5562670R0	P5562670L0
30	70	10x20	2+2	P5563070R0	P5563070L0
35	70	10x20	2+2	P5563570R0	P5563570L0

 DP hinge boring bit.

 Broca para bisagras de DP.

 Mèche à tête cylindrique en DP.

 DP Beschlagbohrer.



# Frese speciali Esempi di lavorazione

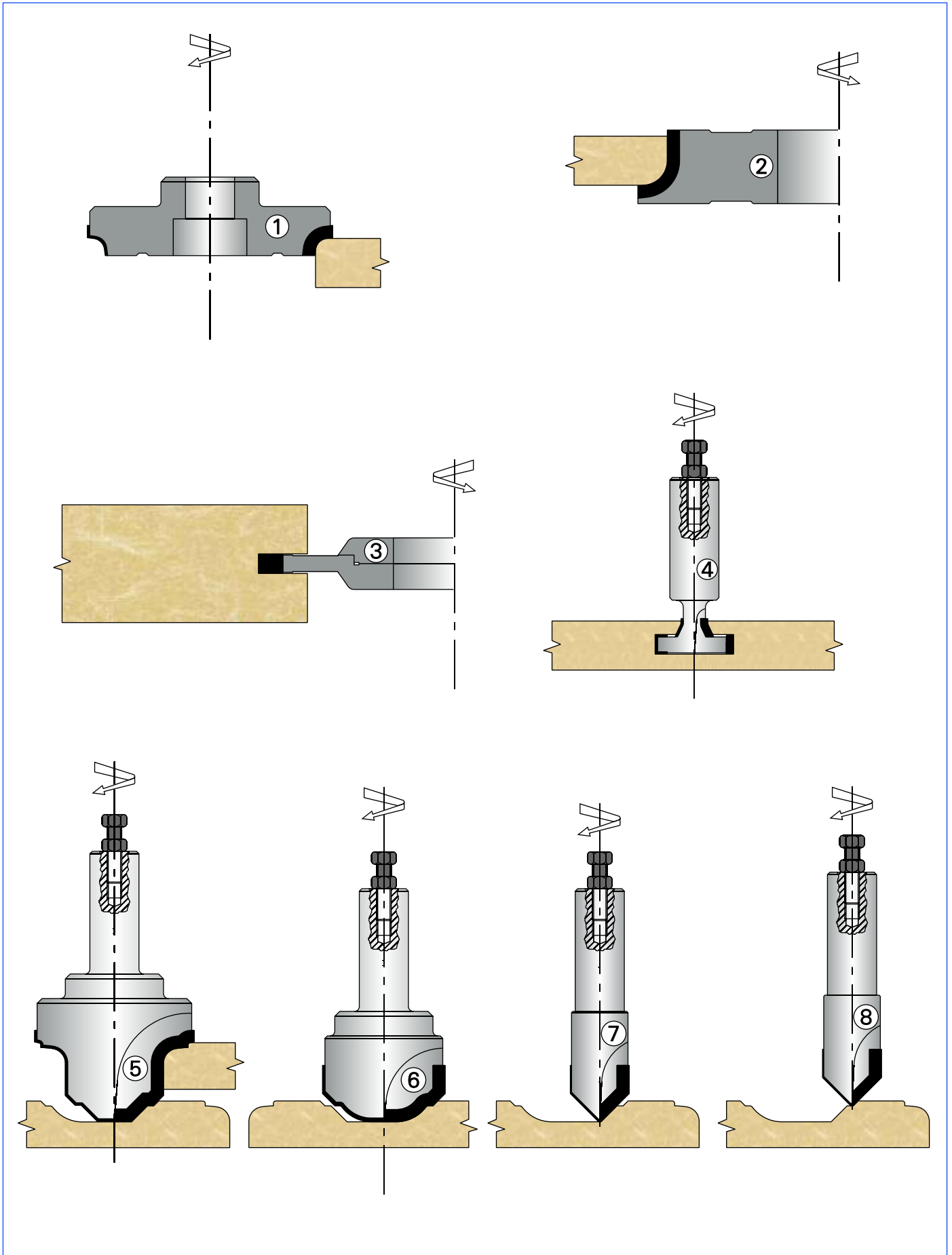

 Examples of DP cutters produced upon request.

 Ejemplos de fresas de DP fabricadas sobre pedido.

 Exemples de fraises en DP fabriquées sur demande.

 Beispiele von DP - Fräsern in Sonderfertigung.















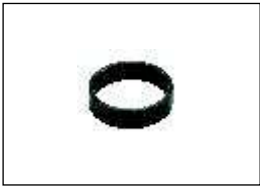

# OMAS

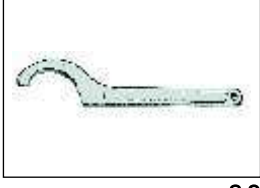
YOUR BEST EQUIPMENT



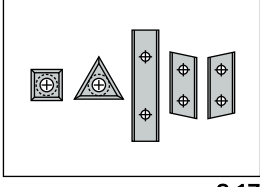
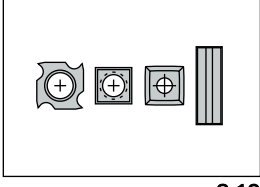
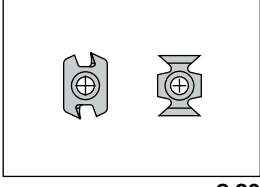
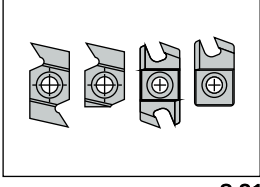
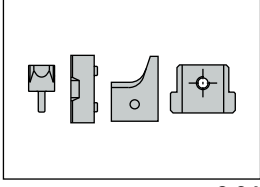
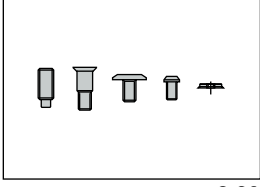
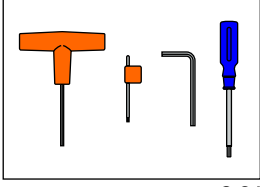

 Complementary items and Spare parts.	 Accesorios y repuestos.
 Accessoires et rechanges.	 Zubehöre und Ersatzteile.

<p>ART. 371 - A</p>  <p>8.2</p>	<p>ART. 371 - B</p>  <p>8.3</p>	<p>ART. 371 - C / D</p>  <p>8.4</p>	<p>ART. 372</p>  <p>8.5</p>
<p>ART. 373</p>  <p>8.6</p>	<p>ART. 373 - A</p>  <p>8.6</p>	<p>ART. 302</p>  <p>8.7</p>	<p>ART. 302 - C</p>  <p>8.8</p>
<p>ART. 303 - A</p>  <p>8.9</p>	<p>ART. 303 - F</p>  <p>8.9</p>	<p>ART. 374 - AL</p>  <p>8.10</p>	<p>ART. 702</p>  <p>8.13</p>
<p>ART. 367</p>  <p>8.14</p>	<p>ART. 368 - A</p>  <p>8.15</p>	<p>ART. 417 - C</p>  <p>8.16</p>	<p>ART. 387 - C</p>  <p>8.16</p>
<p>Inserti HW / HW inserts</p>  <p>8.17</p>	<p>Inserti HW / HW inserts</p>  <p>8.19</p>	<p>Inserti HW / HW inserts</p>  <p>8.20</p>	<p>Inserti HW / HW inserts</p>  <p>8.21</p>
<p>Ricambi / spare parts</p>  <p>8.24</p>	<p>Ricambi / spare parts</p>  <p>8.29</p>	<p>Chiavi / wrenches</p>  <p>8.31</p>	<p>Inserti HW / HW inserts</p> <p><b>Ref.</b></p> <p><b>" OMAS 24 "</b></p> <p>8.33</p>



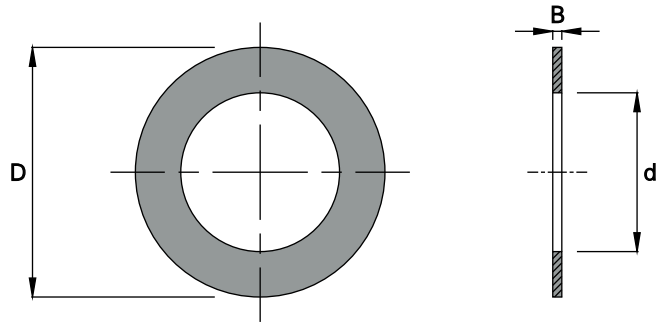

D	B	d	COD.
50	0.1	30	0371A00130
50	0.5	30	0371A00530
50	1	30	0371A01030
50	2	30	0371A02030
50	3	30	0371A03030
50	4	30	0371A04030
50	5	30	0371A05030
50	6	30	0371A06030
50	8	30	0371A08030
50	10	30	0371A10030
50	12	30	0371A12030
50	14	30	0371A14030
50	16	30	0371A16030
50	18	30	0371A18030
50	20	30	0371A20030
50	0.1	31.75	0371A00131
50	0.5	31.75	0371A00531
50	1	31.75	0371A01031
50	2	31.75	0371A02031
50	4	31.75	0371A04031
50	6	31.75	0371A06031
50	8	31.75	0371A08031
50	10	31.75	0371A10031
55	0.1	35	0371A00135
55	0.5	35	0371A00535
55	1	35	0371A01035
55	2	35	0371A02035
55	3	35	0371A03035
55	4	35	0371A04035
55	5	35	0371A05035
55	6	35	0371A06035
55	8	35	0371A08035
55	10	35	0371A10035
55	12	35	0371A12035
55	14	35	0371A14035
55	16	35	0371A16035
55	18	35	0371A18035
55	20	35	0371A20035
60	0.1	40	0371A00140
60	0.5	40	0371A00540
60	1	40	0371A01040
60	2	40	0371A02040
60	3	40	0371A03040
60	4	40	0371A04040
60	5	40	0371A05040
60	6	40	0371A06040
60	8	40	0371A08040

D	B	d	COD.
60	10	40	0371A10040
60	12	40	0371A12040
60	14	40	0371A14040
60	16	40	0371A16040
60	18	40	0371A18040
60	20	40	0371A20040
70	0.1	50	0371A00150
70	0.5	50	0371A00550
70	1	50	0371A01050
70	2	50	0371A02050
70	3	50	0371A03050
70	4	50	0371A04050
70	5	50	0371A05050
70	6	50	0371A06050
70	8	50	0371A08050
70	10	50	0371A10050
70	12	50	0371A12050
70	14	50	0371A14050
70	16	50	0371A16050
70	18	50	0371A18050
70	20	50	0371A20050
80	0.1	60	0371A00160
80	0.5	60	0371A00560
80	1	60	0371A01060
80	3	60	0371A03060
80	4	60	0371A04060
80	5	60	0371A05060
80	6	60	0371A06060
80	8	60	0371A08060
80	10	60	0371A10060
80	12	60	0371A12060
80	14	60	0371A14060
80	16	60	0371A16060
80	18	60	0371A18060
80	20	60	0371A20060



Spacing rings.



Anillos distanciadores.



Bagues de réglage.



Zwischenringe.

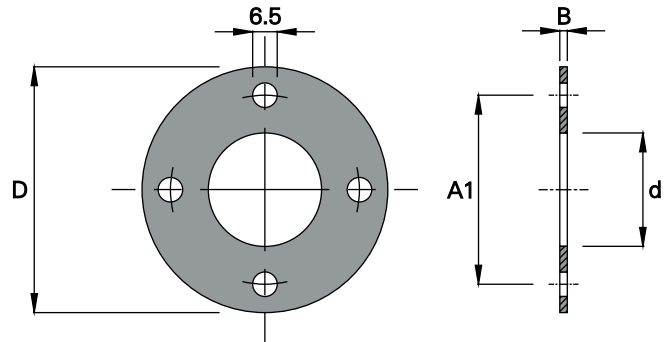

D	B	d	A1	COD.
65	0.1	30	50	0371B00130
65	0.5	30	50	0371B00530
65	1	30	50	0371B01030
65	2	30	50	0371B02030
65	4	30	50	0371B04030
65	6	30	50	0371B06030
65	8	30	50	0371B08030
65	0.1	31.75	50	0371B00131
65	0.5	31.75	50	0371B00531
65	1	31.75	50	0371B01031
65	2	31.75	50	0371B02031
65	4	31.75	50	0371B04031
65	6	31.75	50	0371B06031
65	8	31.75	50	0371B08031
65	0.1	35	50	0371B00135
65	0.5	35	50	0371B00535
65	1	35	50	0371B01035
65	2	35	50	0371B02035
65	4	35	50	0371B04035
65	6	35	50	0371B06035
65	8	35	50	0371B08035
65	0.1	40	50	0371B00140
65	0.5	40	50	0371B00540
65	1	40	50	0371B01040
65	2	40	50	0371B02040
65	4	40	50	0371B04040
65	6	40	50	0371B06040
65	8	40	50	0371B08040
80	0.1	50	65	0371B00150
80	0.5	50	65	0371B00550
80	1	50	65	0371B01050
80	2	50	65	0371B02050
80	4	50	65	0371B04050
80	6	50	65	0371B06050
80	8	50	65	0371B08050

 Spacing rings.

 Anillos distanciadores.

 Bagues de réglage.

 Zwischenringe.



# 371 - C

## Anelli distanziali

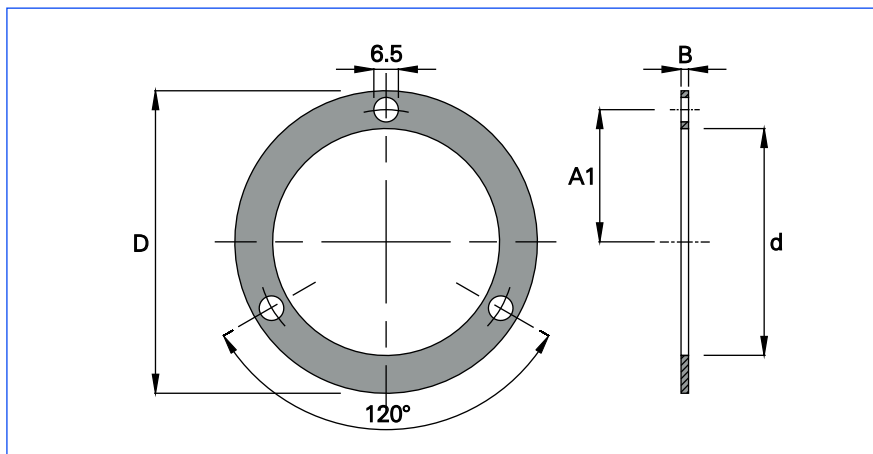

D	B	d	A1	COD.
80	0.1	60	35	0371C00160
80	0.5	60	35	0371C00560
80	1	60	35	0371C01060
80	3	60	35	0371C03060
80	4	60	35	0371C04060
80	5	60	35	0371C05060
80	6	60	35	0371C06060
80	7	60	35	0371C07060
80	8	60	35	0371C08060
80	9	60	35	0371C09060
80	10	60	35	0371C10060
80	12	60	35	0371C12060
80	14	60	35	0371C14060
80	16	60	35	0371C16060
80	20	60	35	0371C20060
80	25	60	35	0371C25060

# 371 - D

## Anelli distanziali

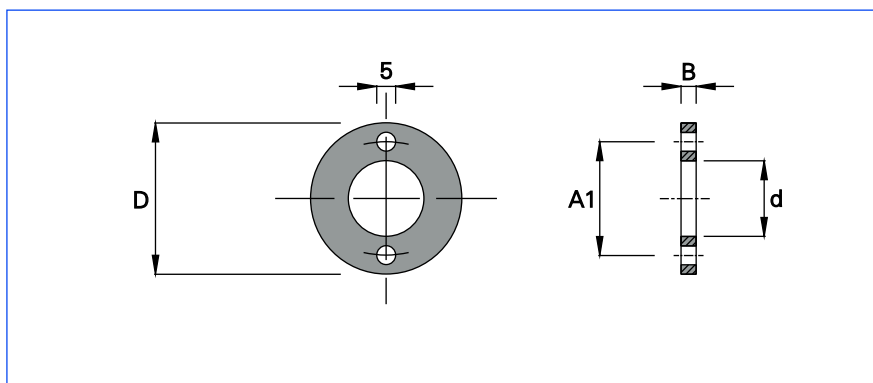

D	B	d	A1	COD.
40	0.1	20	30	0371D00120
40	0.5	20	30	0371D00520
40	1	20	30	0371D01020
40	3	20	30	0371D03020
40	4	20	30	0371D04020
40	6	20	30	0371D06020
40	8	20	30	0371D08020
40	10	20	30	0371D10020
40	16	20	30	0371D16020

 Spacing rings.

 Anillos distanciadores.

 Bagues de réglage.

 Zwischenringe.

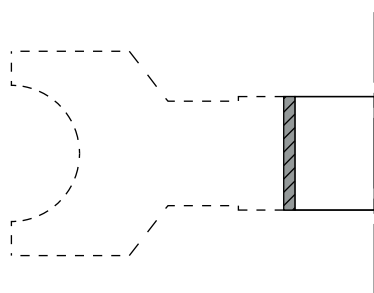
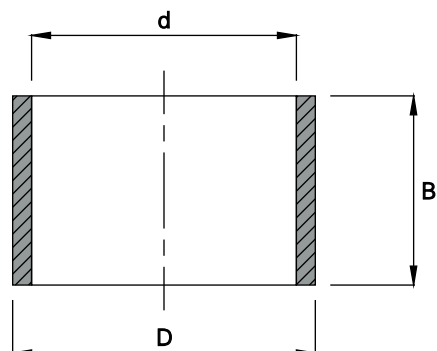

D	B	d	COD.
25	2	20	0372250220
30	2	20	0372300220
30	2	25	0372300225
32	2	20	0372320220
32	2	25	0372320225
32	2	30	0372320230
35	2	20	0372350220
35	2	25	0372350225
35	2	30	0372350230
35	5	30	0372350530
35	10	30	0372351030
35	15	30	0372351530
35	20	30	0372352030
35	25	30	0372352530
35	30	30	0372353030
35	40	30	0372354030
35	50	30	0372355030
35	2	32	0372350232
40	2	30	0372400230
40	2	35	0372400235
40	5	35	0372400535
40	10	35	0372401035
40	15	35	0372401535
40	20	35	0372402035
40	25	35	0372402535
40	30	35	0372403035
40	40	35	0372404035
40	50	35	0372405035

 Reducing bushes.

 Bagues de réductions.

 Anillos reduccion eje.

 Reduzierbüchsen.

# 373

## Coppia di bussole di riduzione con flangia

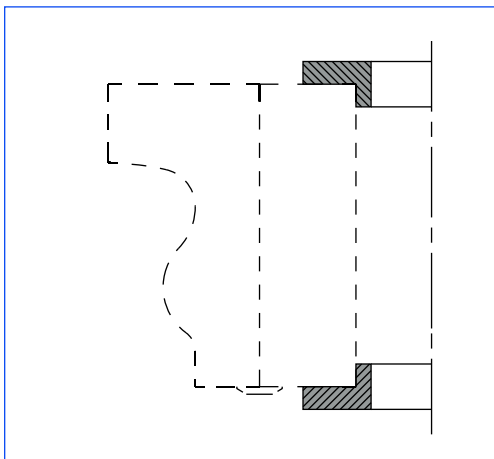
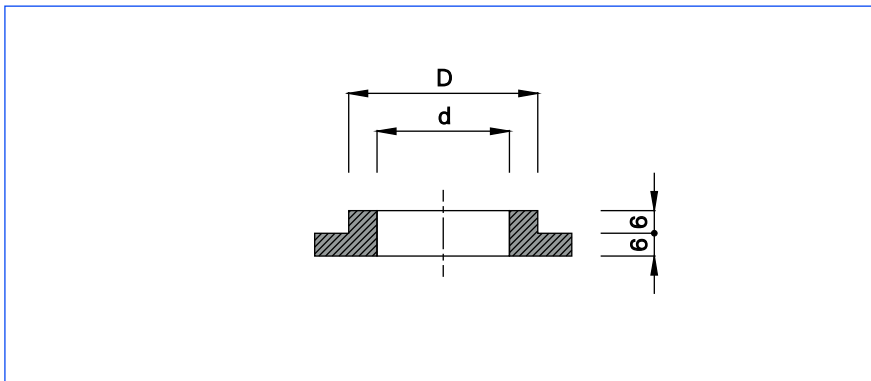

D	d	COD. (COPPIA/PAIR)
35	30	0373353000
40	30	0373403000
40	35	0373403500
50	30	0373503000
50	35	0373503500
50	40	0373504000
SPECIALE		0373SPECIA

# 373 - A

## Coppia di bussole di riduzione con flangia

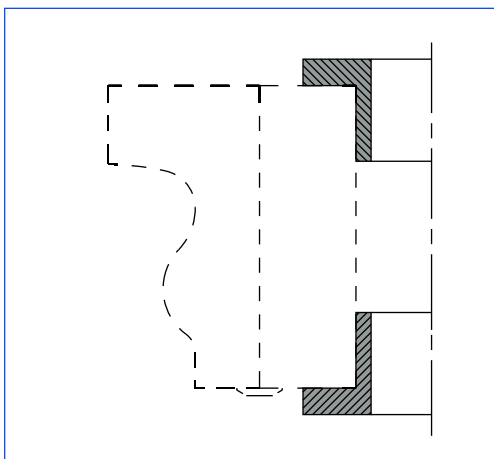
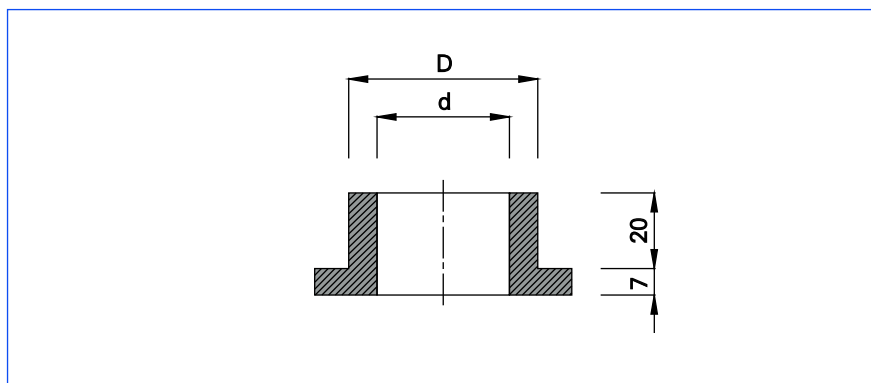

D	d	COD. (COPPIA/PAIR)
50	30	0373A50300
50	31.75	0373A50310
50	35	0373A50350
50	40	0373A50400



Pair of reducing bushes with collar.



Par de anillos reduccion con borde.



Paire de bagues de réductions avec épaulement.



Paar von Reduzierbüchsen mit Bund.

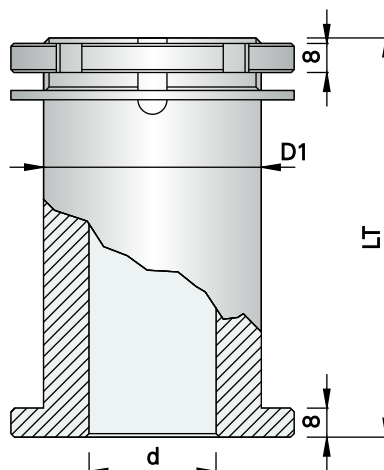

- Completo di ghiera filettata e anello anti - svitamento.
- Utilizzabile per utensili con rotazione sia oraria che anti - oraria.

D1	LT	d	COD.
50	95	30	0302059530
50	110	30	0302051130
50	130	30	0302051330
50	95	31.75	0302059531
50	110	31.75	0302051131
50	130	31.75	0302051331
50	95	35	0302059535
50	110	35	0302051135
50	130	35	0302051335
50	95	40	0302059540
50	110	40	0302051140
50	130	40	0302051340

D1	LT	d	COD.
60	110	30	0302061130
60	130	30	0302061330
60	110	31.75	0302061131
60	130	31.75	0302061331
60	110	35	0302061135
60	130	35	0302061335
60	110	40	0302061140
60	130	40	0302061340
60	60	50	0302066050
60	70	50	0302067050
60	80	50	0302068050
60	90	50	0302069050
60	100	50	0302061050
60	110	50	0302061150
60	120	50	0302061250
60	130	50	0302061350
60	140	50	0302061450

#### Ricambi / Spare parts / Rechanges / Repuestos / Ersatzteile

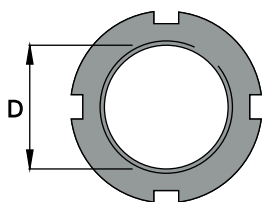

D	COD.
50	03020GH050
60	03020GH060

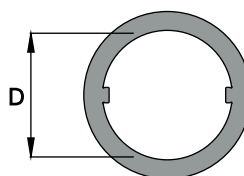

D	COD.
50	03020AAS50
60	03020AAS60



Sleeve for set of tools.  
Complete with locking nut and with anti - unscrewing ring for tools with LH and RH rotation.



Manchon pour jeu de porte - outils.  
Complet avec écrou et bague anti - devissage pour outillage avec rotation LH et RH.



Casquillo para juego de cabezales.  
Completo con tuerca y con anillo anti - aflojamiento para herramientas con rotacion LH y RH.



Spannbüchse für Werkzeugsatz.  
Komplett mit Nutmutter und Sicherungsring für Werkzeuge mit LH und RH Drehrichtung.

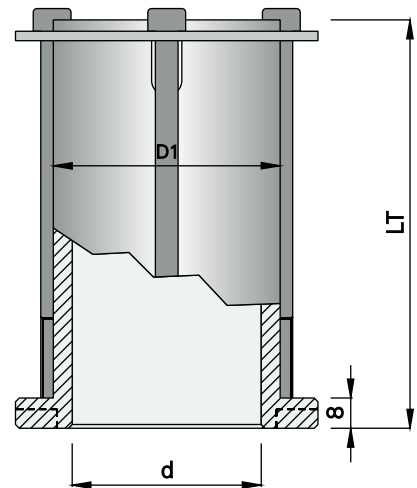

- Utilizzabile per utensili con rotazione sia oraria che anti - oraria.

D1	LT	d	COD.
60	40	50	0302C04050
60	50	50	0302C05050
60	60	50	0302C06050
60	70	50	0302C07050
60	80	50	0302C08050
60	90	50	0302C09050
60	100	50	0302C10050
60	110	50	0302C11050
60	120	50	0302C12050

### Ricambi / Spare parts / Rechanges / Repuestos / Ersatzteile

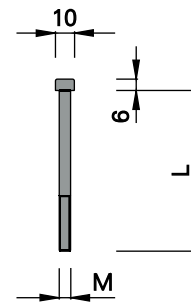
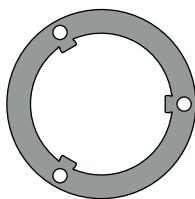

COD.
0302CAAS00

MxL	COD.
6x35	048072B635
6x45	048072B645
6x55	048072B655
6x65	048072B665
6x75	048072B675
6x85	048072B685
6x95	048072B695
6x105	048072B696
6x110	048072B697
6x115	048072B698

 Sleeve for set of tools.

 Casquillo para juego de cabezales.

 Manchon pour jeu de porte - outils.

 Spannbüchse für Werkzeugsatz.

# 303 - A

## Chiave a settore per ghiera

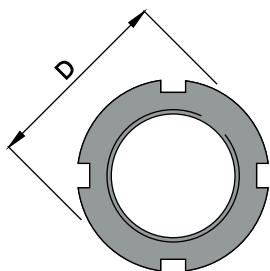
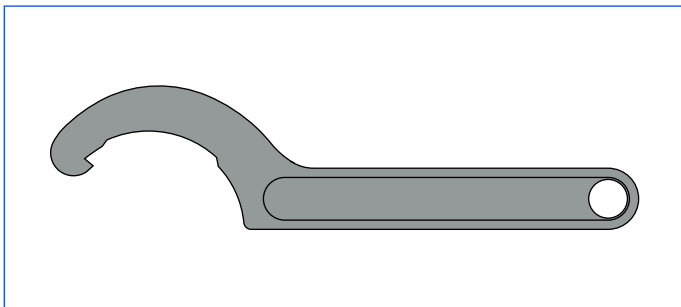
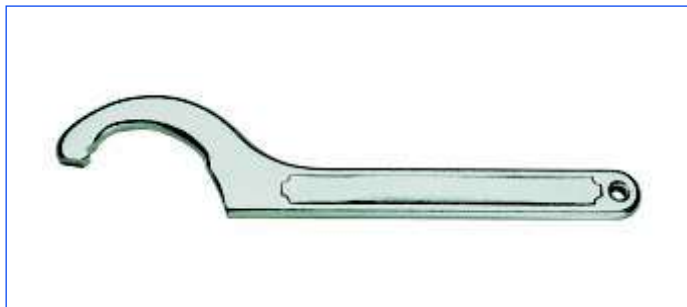

D	COD.
40 - 42	0303A40420
52 - 55	0303A52550
62 - 65	0303A62650
68 - 75	0303A68750
80 - 90	0303A80900

 Hooked wrench for locking nut.

 Llave a sector para tuerca.

 Clef à secteur pour écrou.

 Hakenschlüssel für Nutmutter.

# 303 - F

## Chiave a tubo per ghiera

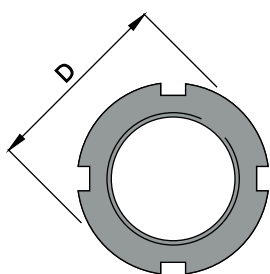
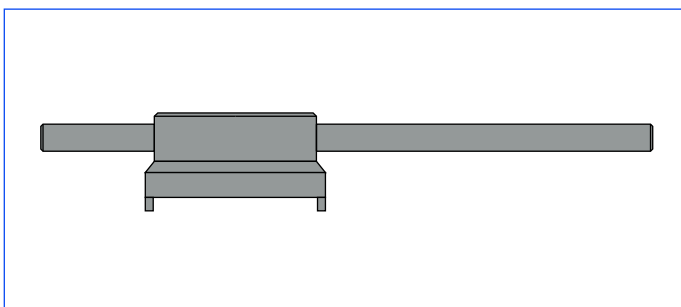

D	COD.
70	0303F70000
80	0303F80000

 Tube - Wrench for locking nut.

 Llave a tubo para tuerca.

 Clef à tube pour écrou.

 Steckschlüssel für Nutmutter.

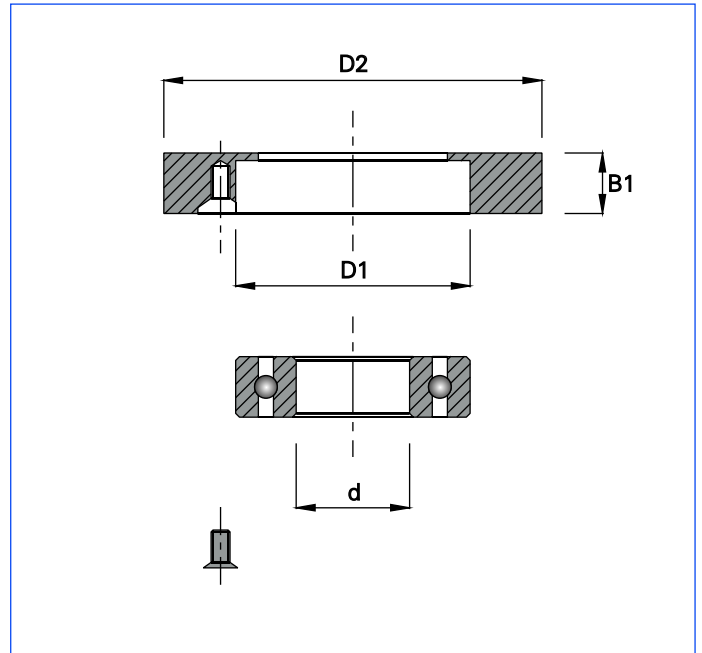

Il set é composto da :

- N° 1 cuscinetto
- N° 9 anelli in lega leggera D2 = 100 - 105 - 110 - 115 - 120 - 125 - 130 - 135 - 140
- N° 1 valigetta in plastica

d	COD. SET
30	0374AL3000
31.75	0374AL3100
35	0374AL3500
40	0374AL4000
50	0374AL5000



Ball bearing with butting ring set.

The set includes :

- 1 ball bearing ;
- 9 light alloy butting rings D2 = 100-105-110-115-120-125-130-135-140;
- 1 plastic case.



Juego de anillos de ataque con cojinete.

El juego comprende :

- 1 cojinete ;
- 9 anillos de ataque de aleacion leggera D2 = 100-105-110-115-120-125-130-135-140;
- 1 estuche de plástico.



Jeu de bagues de copiage avec roulement.

Le jeu comprend :

- 1 roulement ;
- 9 bagues de copiage alliage léger D2 = 100-105-110-115-120-125-130-135-140;
- 1 boîte en plastique.



Anlaufriingsatz mit Kugellager.

Der Satz besteht aus :

- 1 Kugellager ;
- 9 Anlaufriingen aus Leichtmetall D2 = 100-105-110-115-120-125-130-135-140;
- Plastik-Etui.

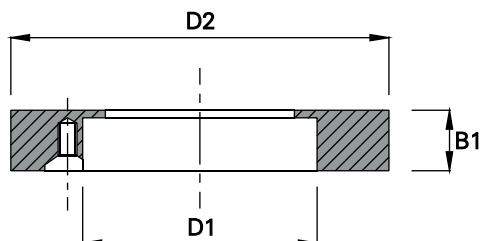

D2	B1	D1	COD.
100	16.5	62	0374100306
100	18.5	80	0374100406
105	16.5	62	0374105306
105	18.5	80	0374105406
110	16.5	62	0374110306
110	18.5	80	0374110406
115	16.5	62	0374115306
115	18.5	80	0374115406
120	16.5	62	0374120306
120	18.5	80	0374120406
125	16.5	62	0374125306
125	18.5	80	0374125406
130	16.5	62	0374130306
130	18.5	80	0374130406
135	16.5	62	0374135306
135	18.5	80	0374135406
140	16.5	62	0374140306
140	18.5	80	0374140406
SPECIALE	16.5	62	0374SPE306
SPECIALE	18.5	80	0374SPE406

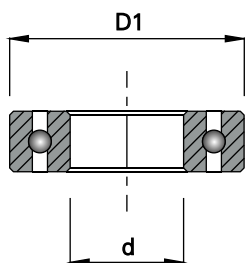

D1	d	COD.
62	30	0374CU3000
62	31.75	0374CU3100
62	35	0374CU3500
80	40	0374CU4000
80	50	0374CU5000

Ricambi / Spare parts / Rechanges / Repuestos / Ersatzteile



COD.

0480720510

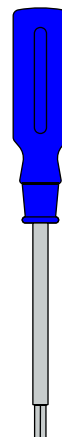

COD.

048078C030



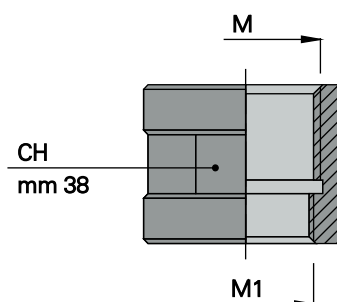

M	M 1	COD. RH	COD. LH
M 33 x 3	∅ 20 x 14 Fil. x 1"	0527D200R0	0527D200L0
M 33 x 3	M 30 x 1.5	0527D300R0	0527D300L0



Locking nut for router.



Tuerca de sujecion para fresadora.



Ecrou de serrage pour défonceuse.



Spannmutter für Oberfräser.

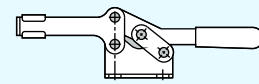
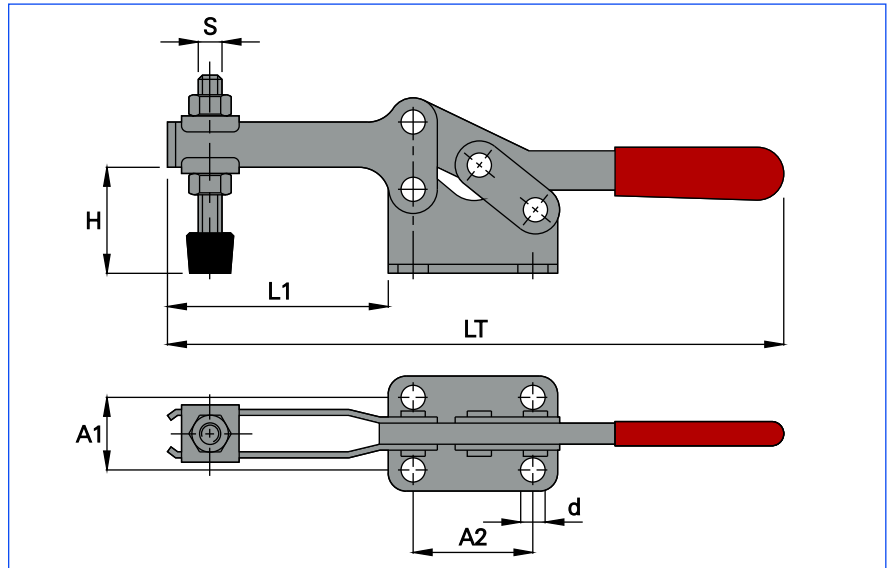

Modello	A1	A2	d	S	H	L1	LT	COD.	COD.
A 240	23	28	6.2	M6	34	55	160	0702A24000	0702PUA240
A 400	26	40	6.5	M8	37	65	200	0702A40000	0702PUA400
A 600	39	56	8.5	M10	51	95	262	0702A60000	0702PUA600
A 700	39	56	8.5	M12	51	110	277	0702A70000	0702PUA700

 Clamping device.

 Dispositivo de sujecion.

 Outil pour blocage.

 Blockierung - Gerät.

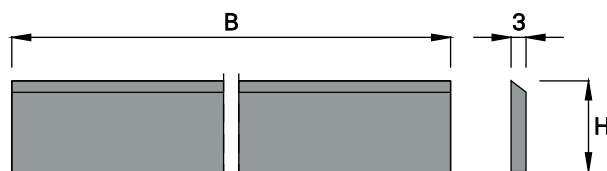
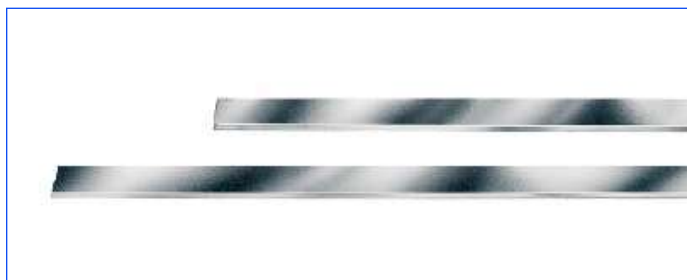

HS - HW

B	H	COD. HS	COD. HW
60	30	03670630HS	03670630HW
80	30	03670830HS	03670830HW
100	30	03671030HS	03671030HW
120	25	03671225HS	03671225HW
120	30	03671230HS	03671230HW
130	30	03671330HS	03671330HW
140	30	03671430HS	03671430HW
150	30	03671530HS	03671530HW
160	30	03671630HS	03671630HW
170	30	03671730HS	03671730HW
180	30	03671830HS	03671830HW
190	25	03671925HS	03671925HW
190	30	03671930HS	03671930HW
200	30	03672030HS	03672030HW
210	30	03672130HS	03672130HW
220	20	03672220HS	03672220HW
220	30	03672230HS	03672230HW
230	30	03672330HS	03672330HW
250	30	03672530HS	03672530HW
260	20	03672620HS	03672620HW
260	30	03672630HS	03672630HW
300	20	03673020HS	03673020HW
300	25	03673025HS	03673025HW
300	30	03673030HS	03673030HW
300	35	03673035HS	03673035HW
310	25	03673125HS	03673125HW
310	30	03673130HS	03673130HW
350	20	03673520HS	03673520HW
350	25	03673525HS	03673525HW
350	30	03673530HS	03673530HW
350	35	03673535HS	03673535HW
400	20	03674020HS	03674020HW
400	30	03674030HS	03674030HW
400	35	03674035HS	03674035HW

B	H	COD. HS	COD. HW
410	30	03674130HS	03674130HW
410	35	03674135HS	03674135HW
500	30	03675030HS	03675030HW
500	35	03675035HS	03675035HW
510	30	03675130HS	03675130HW
510	35	03675135HS	03675135HW
520	30	03675230HS	03675230HW
520	35	03675235HS	03675235HW
530	30	03675330HS	03675330HW
530	35	03675335HS	03675335HW
600	30	03676030HS	03676030HW
600	35	03676035HS	03676035HW
610	30	03676130HS	03676130HW
610	35	03676135HS	03676135HW
630	30	03676330HS	03676330HW
630	35	03676335HS	03676335HW
700	30	03677030HS	03677030HW
700	35	03677035HS	03677035HW



Planing knives.



Cuchillas cepilladoras.



Couteaux à raboter.



Streifenhobelmesser.

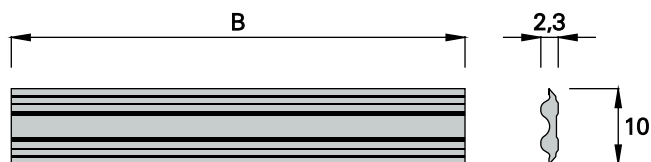

HS - HW

B	COD. HS	COD. HS 18%W	COD. HS M42	COD. HW
60	0368A060HS	0368A06018	0368A06042	0368A060HW
75	0368A075HS	0368A07518	0368A07542	0368A075HW
80	0368A080HS	0368A08018	0368A08042	0368A080HW
90	0368A090HS	0368A09018	0368A09042	0368A090HW
95	0368A095HS	0368A09518	0368A09542	0368A095HW
100	0368A100HS	0368A10018	0368A10042	0368A100HW
110	0368A110HS	0368A11018	0368A11042	0368A110HW
115	0368A115HS	0368A11518	0368A11542	0368A115HW
120	0368A120HS	0368A12018	0368A12042	0368A120HW
125	0368A125HS	0368A12518	0368A12542	0368A125HW
130	0368A130HS	0368A13018	0368A13042	0368A130HW
135	0368A135HS	0368A13518	0368A13542	0368A135HW
140	0368A140HS	0368A14018	0368A14042	0368A140HW
145	0368A145HS	0368A14518	0368A14542	0368A145HW
150	0368A150HS	0368A15018	0368A15042	0368A150HW
160	0368A160HS	0368A16018	0368A16042	0368A160HW
170	0368A170HS	0368A17018	0368A17042	0368A170HW
180	0368A180HS	0368A18018	0368A18042	0368A180HW
185	0368A185HS	0368A18518	0368A18542	0368A185HW
190	0368A190HS	0368A19018	0368A19042	0368A190HW
200	0368A200HS	0368A20018	0368A20042	0368A200HW
210	0368A210HS	0368A21018	0368A21042	0368A210HW
220	0368A220HS	0368A22018	0368A22042	0368A220HW
230	0368A230HS	0368A23018	0368A23042	0368A230HW
235	0368A235HS	0368A23518	0368A23542	0368A235HW
240	0368A240HS	0368A24018	0368A24042	0368A240HW
250	0368A250HS	0368A25018	0368A25042	0368A250HW
260	0368A260HS	0368A26018	0368A26042	0368A260HW
265	0368A265HS	0368A26518	0368A26542	0368A265HW

B	COD. HS	COD. HS 18%W	COD. HS M42	COD. HW
270	0368A270HS	0368A27018	0368A27042	0368A270HW
280	0368A280HS	0368A28018	0368A28042	0368A280HW
300	0368A300HS	0368A30018	0368A30042	0368A300HW
310	0368A310HS	0368A31018	0368A31042	0368A310HW
320	0368A320HS	0368A32018	0368A32042	0368A320HW
330	0368A330HS	0368A33018	0368A33042	0368A330HW
350	0368A350HS	0368A35018	0368A35042	0368A350HW
360	0368A360HS	0368A36018	0368A36042	0368A360HW
400	0368A400HS	0368A40018	0368A40042	0368A400HW
410	0368A410HS	0368A41018	0368A41042	0368A410HW
415	0368A415HS	0368A41518	0368A41542	0368A415HW
420	0368A420HS	0368A42018	0368A42042	0368A420HW
430	0368A430HS	0368A43018	0368A43042	0368A430HW
450	0368A450HS	0368A45018	0368A45042	0368A450HW
500	0368A500HS	0368A50018	0368A50042	0368A500HW
510	0368A510HS	0368A51018	0368A51042	0368A510HW
520	0368A520HS	0368A52018	0368A52042	0368A520HW
530	0368A530HS	0368A53018	0368A53042	0368A530HW
540	0368A540HS	0368A54018	0368A54042	0368A540HW
600	0368A600HS	0368A60018	0368A60042	0368A600HW
610	0368A610HS	0368A61018	0368A61042	0368A610HW
630	0368A630HS	0368A63018	0368A63042	0368A630HW
635	0368A635HS	0368A63518	0368A63542	0368A635HW
640	0368A640HS	0368A64018	0368A64042	0368A640HW
650	0368A650HS	0368A65018	0368A65042	0368A650HW
COIL				
60	036806MTHS	—	036806MT42	—
mt.				
COIL				
120	036812MTHS	036812MT18	036812MT42	—
mt.				



Planing knives to fit cutter heads.



Cuchillas cepilladoras para cabezales.



Couteaux pour porte-outils à raboter.



Hobelmesser für messerköpfe

# 417 - C

## Coltelli reversibili HW

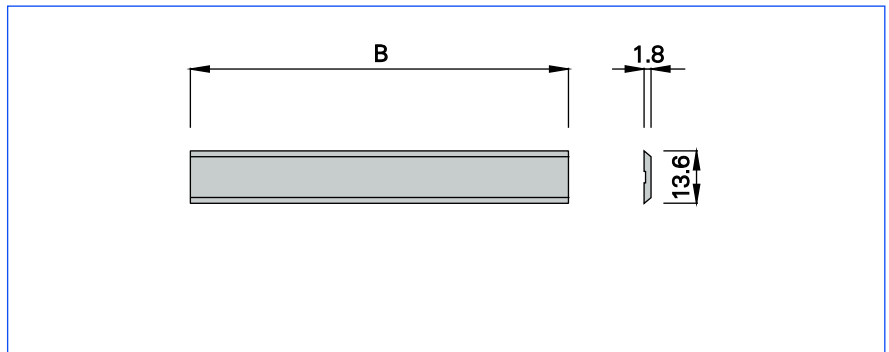

HW

B	COD.
100	0417C100HW
120	0417C120HW
130	0417C130HW
140	0417C140HW
160	0417C160HW
180	0417C180HW
190	0417C190HW
210	0417C210HW
230	0417C230HW
245	0417C245HW
265	0417C265HW



HW turnover knives.



Cuchillas reversibles de HW.



Couteaux réversibles en HW.



HW - Wendemesser.

# 387 - C

## Coltelli per teste pialla art. 386

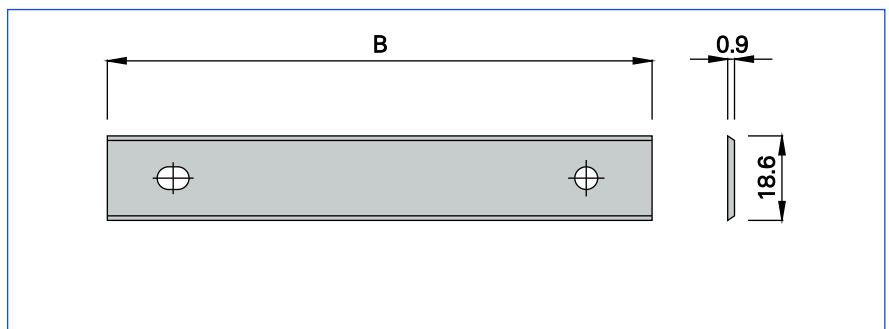

HS

B	COD.
60	0387C060HS
80	0387C080HS
100	0387C100HS
120	0387C120HS
130	0387C130HS
140	0387C140HS
150	0387C150HS
170	0387C170HS
180	0387C180HS
190	0387C190HS
200	0387C200HS
210	0387C210HS
230	0387C230HS



Turnover knives for planing heads art. 386.



Cuchillas reversibles para cabezales art. 386.



Couteaux réversibles pour porte - outils art. 386.



Wendemesser für Hobelmesserkopf art. 386.

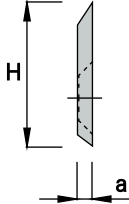
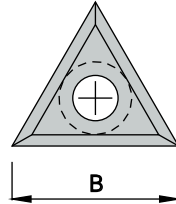

HW			B	H	a	COD.
			22	20	2	0480020000

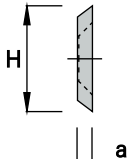
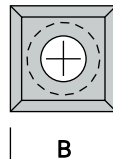
HW			B	H	a	COD.
			14	14	2	0480030014

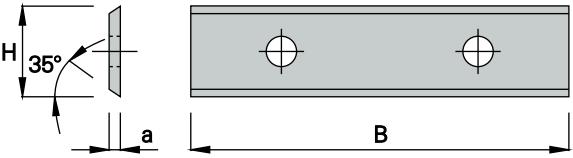
HW		B	H	a	COD.
		7.6	12	1.5	0480050007
		9	12	1.5	0480050009
		9.6	12	1.5	0480050096
		11	12	1.5	0480050011
		12	12	1.5	0480050012
		15	12	1.5	0480050015
		16	12	1.5	0480050016
		17	12	1.5	0480050017
		20	12	1.5	0480050020
		30	12	1.5	0480050030
		40	12	1.5	0480050040
		50	12	1.5	0480050050
		60	12	1.5	0480050060
		80	13	2.2	0480050080
		100	13	2.2	0480050100

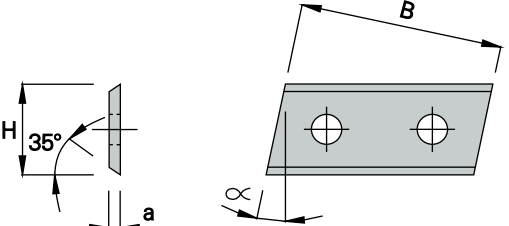
HW		B	H	$\alpha$	a	COD.
		7.5	12	6°	1.5	0480070607
		9	12	6°	1.5	0480070609
		18.5	12	6°	1.5	0480070618
		28.5	12	6°	1.5	0480070628
		7.5	12	12°	1.5	0480071207
		9	12	12°	1.5	0480071209
		17	12	12°	1.5	0480071217
		26.8	12	12°	1.5	0480071226
		7.5	12	15°	1.5	0480071507
		9	12	15°	1.5	0480071509
		16	12	15°	1.5	0480071516
		25.8	12	15°	1.5	0480071525

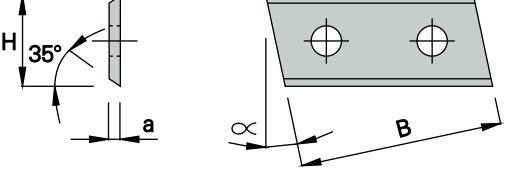
HW		B	H	$\alpha$	a	COD.
		7.5	12	6°	1.5	0480080607
		9	12	6°	1.5	0480080609
		18.5	12	6°	1.5	0480080618
		28.5	12	6°	1.5	0480080628
		7.5	12	12°	1.5	0480081207
		9	12	12°	1.5	0480081209
		17	12	12°	1.5	0480081217
		26.8	12	12°	1.5	0480081226
		7.5	12	15°	1.5	0480081507
		9	12	15°	1.5	0480081509
		16	12	15°	1.5	0480081516
		25.8	12	15°	1.5	0480081525



**HW**

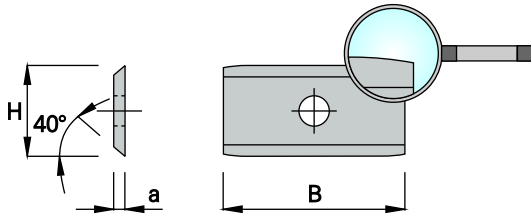

B	H	a	COD.
24	12	1.5	048015E240

**HW**

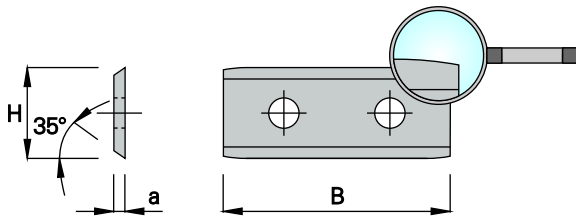

B	H	a	COD.
30	12	1.5	048015E300
50	12	1.5	048015E500

**HW** MICROGRANO  
MICROGRAIN

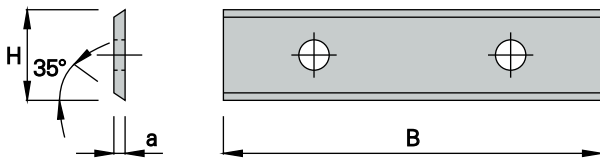

B	H	a	COD.
7.5	12	1.5	0480051007
12	12	1.5	0480051012
15	12	1.5	0480051015
20	12	1.5	0480051020
30	12	1.5	0480051030
50	12	1.5	0480051050
60	12	1.5	0480051060

**HW** PER LEGNI TENERI  
FOR SOFT WOOD

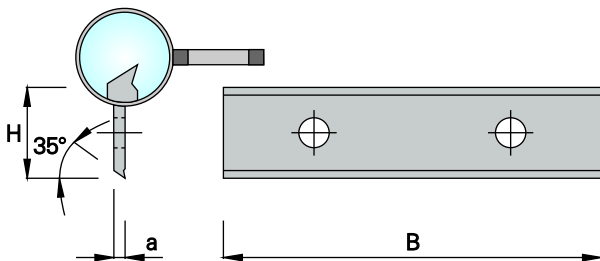

B	H	a	COD.
20	12	1.5	0480053020
30	12	1.5	0480053030
50	12	1.5	0480053050

**HW** PER LEGNI TENERI  
FOR SOFT WOOD

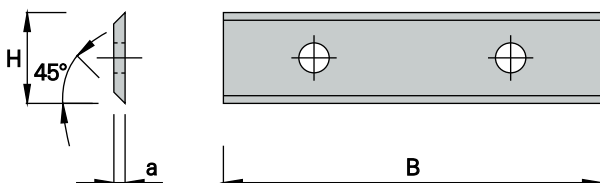

B	H	a	COD.
7,5	12	1.5	0480055007
12	12	1.5	0480055012
15	12	1.5	0480055015
20	12	1.5	0480055020
30	12	1.5	0480055030
40	12	1.5	0480055040
50	12	1.5	0480055050
60	12	1.5	0480055060



**HW**

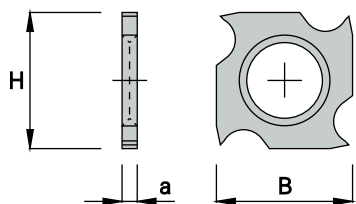

B	H	a	COD.
18	18	1.95	048020A000

**HW**

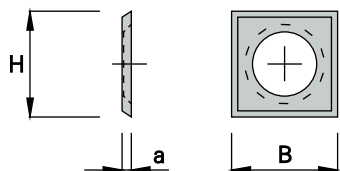

B	H	a	COD.
14	14	1.2	048020B000

**HW**

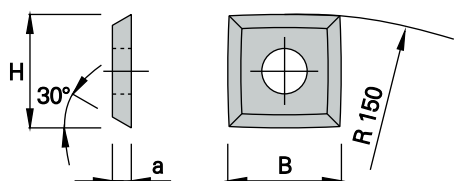

B	H	a	COD.
15	15	2.5	048125A000

**HW**

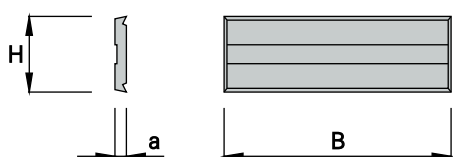

B	H	a	COD.
20	5.5	1.1	0517A00000
30	6.5	1.1	0517B00000
30	10	1.5	0517C00000





HW	B	H	a	COD.
	8.2	11	1.5	0519A00000
	9.2	11	1.5	0519B00000
	10.2	11	1.5	0519C00000
	11.2	11.2	1.5	0519D00000

HW	45°	R 1.5	R 3	R 5
	K480110000	K480130000	K480150000	K48015R500

HW	45°	R 1.5	R 3	R 5
	K480120000	K480140000	K480160000	K48016R500

HW	45°	R 2	R 3
	0480110000	0480120000	0480150000

HW	45°	R 2	R 3
	0480130000	0480140000	0480160000



<b>HW</b> 	B	COD.
	2.5	048019M000

<b>HW</b> 	B	COD.
	3	048019A000
	4	048019B000
	5	048019C000
	6	048019D000

<b>HW</b> 	B	COD.①	COD.②	COD.③
	3	048019A00I	048019A00S	048019A00T

<b>HW</b> 	B	COD.①	COD.②
	4	048019B00I	048019B00S
	5	048019C00I	048019C00S

<b>HW</b> 	B	COD.
	4	048019N000
	5	048019P000
	6	048019Q000



HW						Tipo	COD.
	A	B	C	D	A	K480183500	
					B	K48018R300	
					C	K480185700	
					D	K48018R400	

HW		B	COD.
		8	0480188400

HW		B	COD.
		5	048017R000

HW		B x P	ROT.	COD.
		3 x 6	RH	048017A0RH
		3 x 6	LH	048017A0LH
		4 x 8	LH	048017B000
		5 x 9	RH	048017C000
		4 x 8	RH	048017E000
		5 x 5	RH	048017F000
		3 x 8	RH	048017G000
		3 x 8	LH	048017H000
		4 x 12	RH	048017L100
		4 x 12	LH	048017L200

HW		Tipo	B	R	ROT.	COD.	
		A	4		RH	04801800RH	
		B	4		LH	04801800LH	
		C	6	3			048018R300
			8	4			048018R400

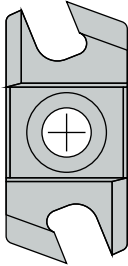
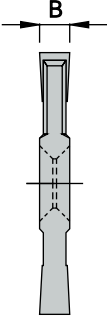

<b>HW</b> 		B	COD.
		3	K48017A000
		4	K48017E000
		5	K48017F000

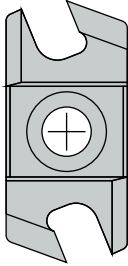
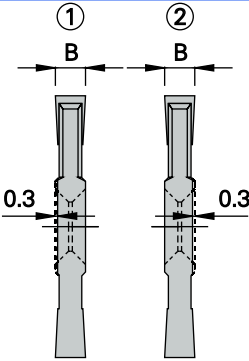
<b>HW</b> 		B	COD.①	COD.②
		3	K48017A00I	K48017A00S
		4	K48017E00I	K18017E00S
		5	K48017F00I	K48017F00S

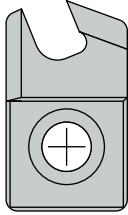
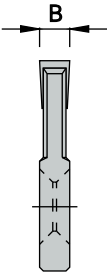
<b>HW</b> 		B	COD.
		4	K48017L000

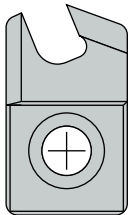
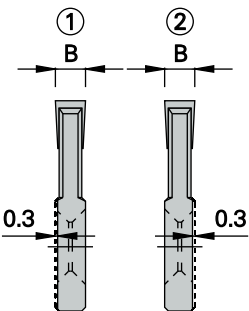
<b>HW</b> 		B	COD.①	COD.②
		4	K48017L00I	K48017L00S

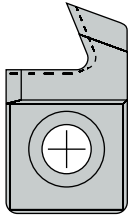
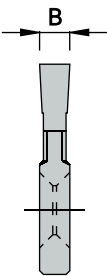
<b>HW</b> 		B	COD.
		4	048017LSL0



	<b>Tipo</b>	<b>COD.</b>
	A	048060A000
	B	048060B000
	C	048060C000

	<b>L</b>	<b>COD.</b>
	7	0480500700
	10	0480501000
	13	0480501300
	18	0480501800
	26	0480502600
	36	0480503600
	46	0480504600
	56	0480505600
	76	0480507600
	96	0480509600

	<b>L</b>	<b>COD.</b>
	15	0480571500
	18	0480571800

	<b>L</b>	<b>COD.</b>
	15	0480581500
	18	0480581800

<p><b>COD.</b> 04805715EC</p>	<p><b>COD.</b> 04805715EL</p>
-----------------------------------	-----------------------------------

<p><b>COD.</b> 048050AUVZ</p>	<p><b>COD.</b> 048050AST1</p>	<p><b>COD.</b> 048050AST2</p>
-----------------------------------	-----------------------------------	-----------------------------------

<p><b>COD.</b> K48050APQ5</p>
-----------------------------------

<p><b>COD.</b> K48050APQ6</p>
-----------------------------------

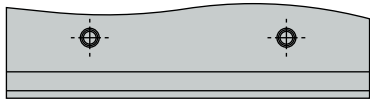

COD.  
K48050AK10

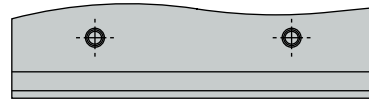
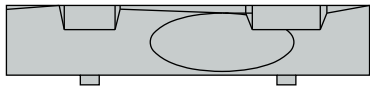

COD.  
K48050AK20

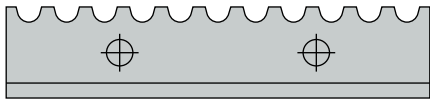
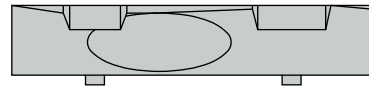

COD.  
0480505628

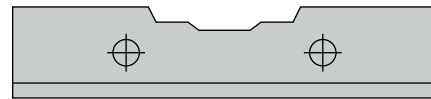
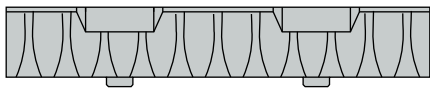

COD.  
048050AET0

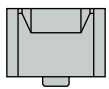
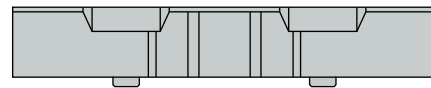

COD.  
048053K439

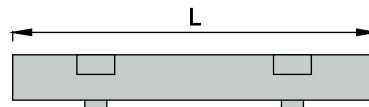
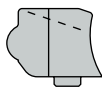

L	COD.
38	048050ZPA0
48	048050Z000

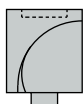

COD.  
048053B000

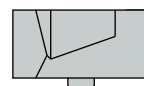
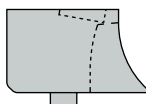

COD.  
048053H000

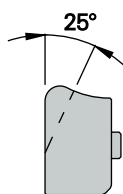
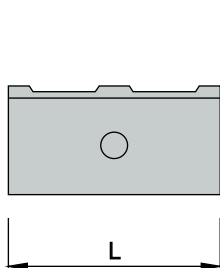
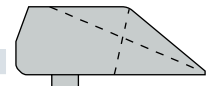

L	COD.
10	0480521025
13	0480521325
18	0480521825
23	0480522325
28	0480522825
38	0480523825
58	0480525825
78	0480527825

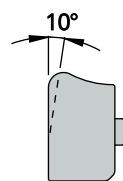
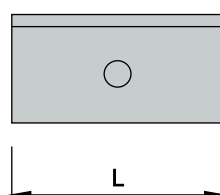

L	COD.
10	0480521010
13	0480521310
18	0480521810
23	0480522310
28	0480522810
38	0480523810
58	0480525810
78	0480527810



	L	COD.
	13	048053132R
	18	048053182R
	23	048053232R
	28	048053282R
	38	048053382R
	58	048053582R

	L	COD.
	13	048053131R
	18	048053181R
	23	048053231R
	28	048053281R
	38	048053381R
	58	048053581R

	L	COD.
	13	048053132L
	18	048053182L
	23	048053232L
	28	048053282L
	38	048053382L
	58	048053582L

	L	COD.
	13	048053131L
	18	048053181L
	23	048053231L
	28	048053281L
	38	048053381L
	58	048053581L

	L	COD.
	28	04805128F0
	38	04805138F0
	58	04805158F0
	78	04805178F0



	L	COD.
	28	04805128G0
	38	04805138G0
	58	04805158G0
	78	04805178G0

	L	COD.
	28	04805128H0
	38	04805138H0
	58	04805158H0

	L	COD.
	28	04805128L0
	38	04805138L0
	58	04805158L0

	L	COD.
	28	04805128T0

	L	COD.
	38	04805138T0





L	COD.
60	048050P060
80	048050P080
100	048050P100
120	048050P120
130	048050P130
140	048050P140
150	048050P150
170	048050P170
180	048050P180
190	048050P190
210	048050P210
230	048050P230

L	COD.
60	048050R060
80	048050R080
100	048050R100
120	048050R120
130	048050R130
140	048050R140
150	048050R150
170	048050R170
180	048050R180
190	048050R190
210	048050R210
230	048050R230

**COD.**  
048062A000

**COD.**  
048062B000

**COD.**  
048062C000

**COD.**  
K48062E000

**PER TESTE ART. 394-T E K394-T  
FOR CUTTER HEADS ART.394-T AND K394-T**

**COD.**  
048053394T

**PER ART.426-1 E K426-1 / FOR ART.426-1 AND K426-1**

**COD.**  
0480791000



	MxLT	COD.		MxLT	COD.
	5x12	0480700512		6x20	0480705620
	6x8	0480700608			
	6x12	0480700612			
	6x15	0480700615			
	6x20	0480700620			
	8x12	0480700812			
	8x15	0480700815			
	8x20	0480700820			
	10x20	0480701020			
12x25	0480701225				

	MxLT	COD.		MxLT	COD.
	5x6.5	0480710700		2.5x2.5	048070P202
	5x10	0480711000		4x4	048070P404
				5x5	048070P505

	MxLT	COD.		MxLT	COD.
	5x6.5	048074A507		5x10	048074B510
	5x10	048074A510		5x12	048074B512
				5x15	048074B515
				5x18	048074B518

	MxLT	COD.		MxLT	COD.
	5x16	048074C516		5x14	048074C514

	MxLT	COD.		MxLT	COD.
	5x11	048074C512		5x15	048074C515



MxLT	COD.	MxL	COD.
4x14	0480720414	3x10	048072B310
5x10	0480720510	4x10	048072B410
5x12	0480720512	5x10	048072B510
5x15	0480720515	5x16	048072B516
5x18	0480720518	6x10	048072B610
5x20	0480720520	6x16	048072B616
6x10	0480720610	6x20	048072B620
		6x35	048072B635
		6x45	048072B645
		6x55	048072B655
		6x65	048072B665
		6x75	048072B675
		6x85	048072B685
		6x95	048072B695
		6x105	048072B696
		6x110	048072B697
		6x115	048072B698

<p>COD. 048073A000</p>	<p>COD. 048073B000</p>	<p>COD. 048074P350</p>	<p>COD. 048074P460</p>
----------------------------	----------------------------	----------------------------	----------------------------

MxLT	COD.	MxLT	COD.
3.5x7	0480730407	4x3.4	048020C000
3.5x9	0480730409		

<p>COD. 048020D000</p>	<p>COD. 048020E000</p>
----------------------------	----------------------------

D2	a	d	COD.
15	0.1	5.25	0480750015
15	0.5	5.25	0480750055
15	1	5.25	0480750105
13	0.1	6.5	0480750016
13	0.5	6.5	0480750056
13	1	6.5	0480750106

<p>COD. 048060P000</p>	<p>COD. 048070Z126</p>
----------------------------	----------------------------

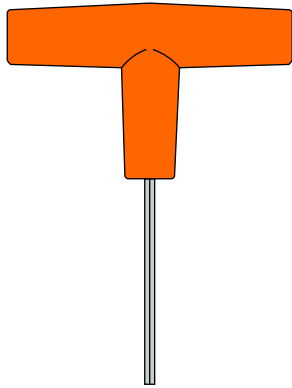

E	COD.
2.5	0480782500
3	0480783000
4	0480784000

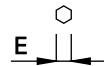
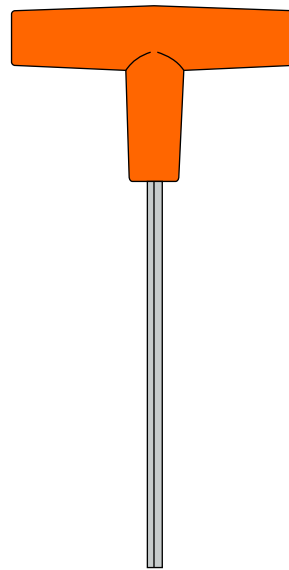

E	COD.
4	048078L400
5	048078L500

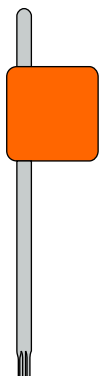

	COD.
T 09	048020F000
T 15	048076T150

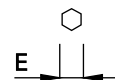
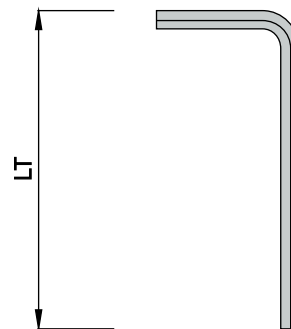

E	LT	COD.
1.3	45	048078Z013
2	62	048078Z020
2.5	59	048078Z025
5	85	048078Z050
5	162	048078ZL50
6	98	048078Z060



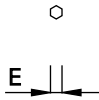
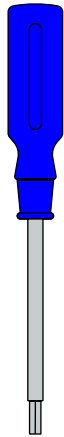

E COD.

3 048078C030

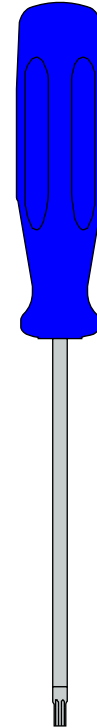

COD.

T 15 048078T150

T 20 048078T200

TOP QUALITY

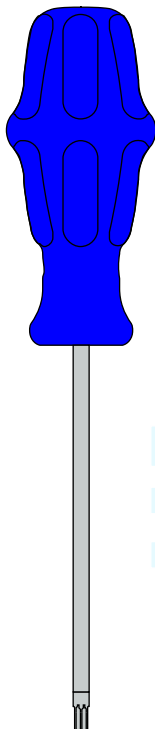

COD.

T 09 048078T09E

T 15 048078T15E

T 20 048078T20E



COD.

T 20 048078T20L



PER ART. 405 - A / FOR ART. 405 - A

**HW**

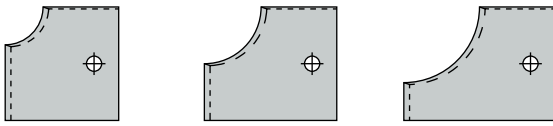

COD.  
0754R10002

COD.  
0754R15002

COD.  
0754R20002

PER ART. 405 - B / FOR ART. 405 - B

**HW**

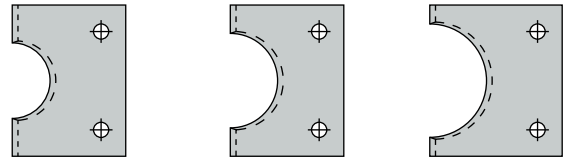

COD.  
0742R10002

COD.  
0742R12502

COD.  
0742R15002

SUPPORTI PER ART. 405 - A / SUPPORT PLATES FOR ART. 405 - A

**SP**

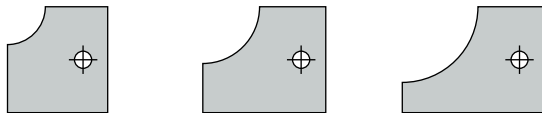

COD.  
0754R10001

COD.  
0754R15001

COD.  
0754R20001

SUPPORTI PER ART. 405 - B / SUPPORT PLATES FOR ART. 405 - B

**SP**

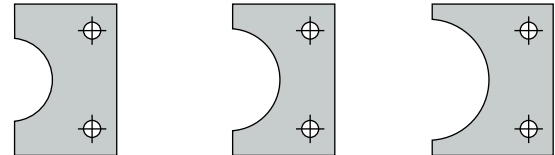

COD.  
0742R10001

COD.  
0742R12501

COD.  
0742R15001

PER ART. K423 / FOR ART. K423

**HW**

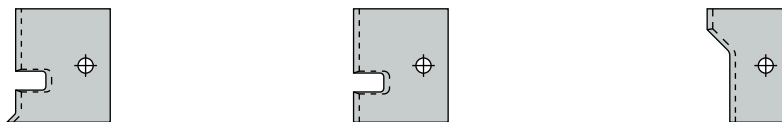

COD.  
K48023E100

COD.  
K48023F100

COD.  
K48023G100

PER ART. 421 - 422 / FOR ART. 421 - 421

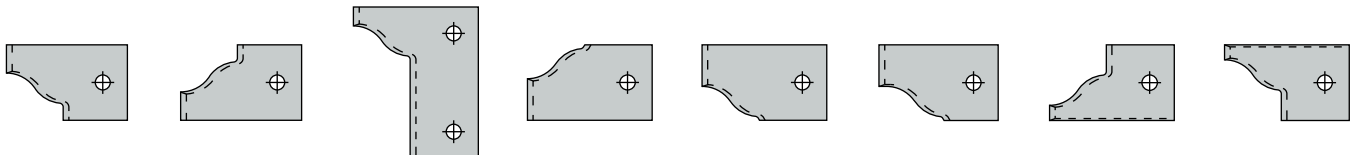

COD.  
048021A000

COD.  
048021B000

COD.  
048021C000

COD.  
048021D000

COD.  
048021G000

COD.  
048021H000

COD.  
048022C000

COD.  
048022D000

PER ART. K421 - K422 / FOR ART. K421 - K421

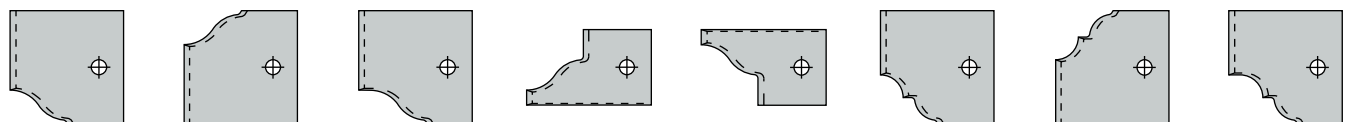

COD.  
K48021A000

COD.  
K48021B000

COD.  
K48021F000

COD.  
K48022A000

COD.  
K48022B000

COD.  
K48021H000

COD.  
K48021K000

COD.  
K48021L000

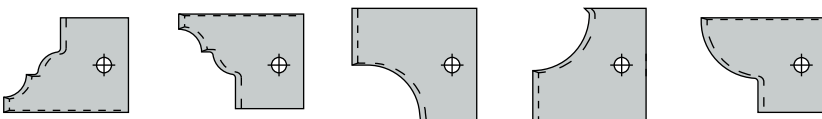

COD.  
K48022C000

COD.  
K48022D000

COD.  
K48021S000

COD.  
K48021T000

COD.  
K48022E000

Inserts for items out of production.  
Ref.catalogue "OMAS 24".

Cuchillas para herramientas fuera de produccion.  
Ref.catalogo "OMAS 24".

Plaquettes pour articles hors de production.  
Ref.catalogue "OMAS 24".

Platten für Artikel aus der Produktion.  
Sieh Katalog "OMAS 24".



**HW**

PER ART. 427-1  
FOR ART. 427-1



COD.  
048027L100



COD.  
048027M100



COD.  
048027E100



COD.  
048027F100

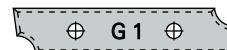

COD.  
048027G100

**HW**

PER ART. 427-2  
FOR ART. 427-2



COD.  
048027L200



COD.  
048027M200

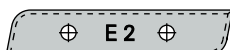

COD.  
048027E200

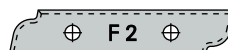

COD.  
048027F200

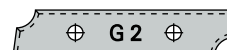

COD.  
048027G200

**HW**

PER ART. 427-3 / FOR ART. 427-3



COD.  
K48027K100



COD.  
K48027M100

**HW**

PER ART. 427-4 / FOR ART. 427-4



COD.  
K48027K200



COD.  
K48027M200

**HW**

PER ART. 427-5 / FOR ART. 427-5



COD.  
K48027P100

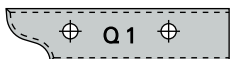

COD.  
K48027Q100



COD.  
K48027R100

**HW**

PER ART. 427-6 / FOR ART. 427-6

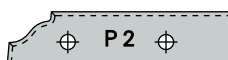

COD.  
K48027P200

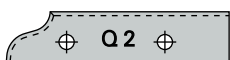

COD.  
K48027Q200



COD.  
K48027R200





Inserts for items out of production.  
Ref.catalogue "OMAS 24".

Cuchillas para herramientas fuera de produccion.  
Ref.catalogo "OMAS 24".

Plaquettes pour articles hors de production.  
Ref.catalogue "OMAS 24".

Platten für Artikel aus der Produktion.  
Sieh Katalog "OMAS 24".

## *Attrezzature per Infissi*

-  Window tool sets
-  Outillage pour fenêtres
-  Herramientas para ventanas
-  Fenster-Garnituren





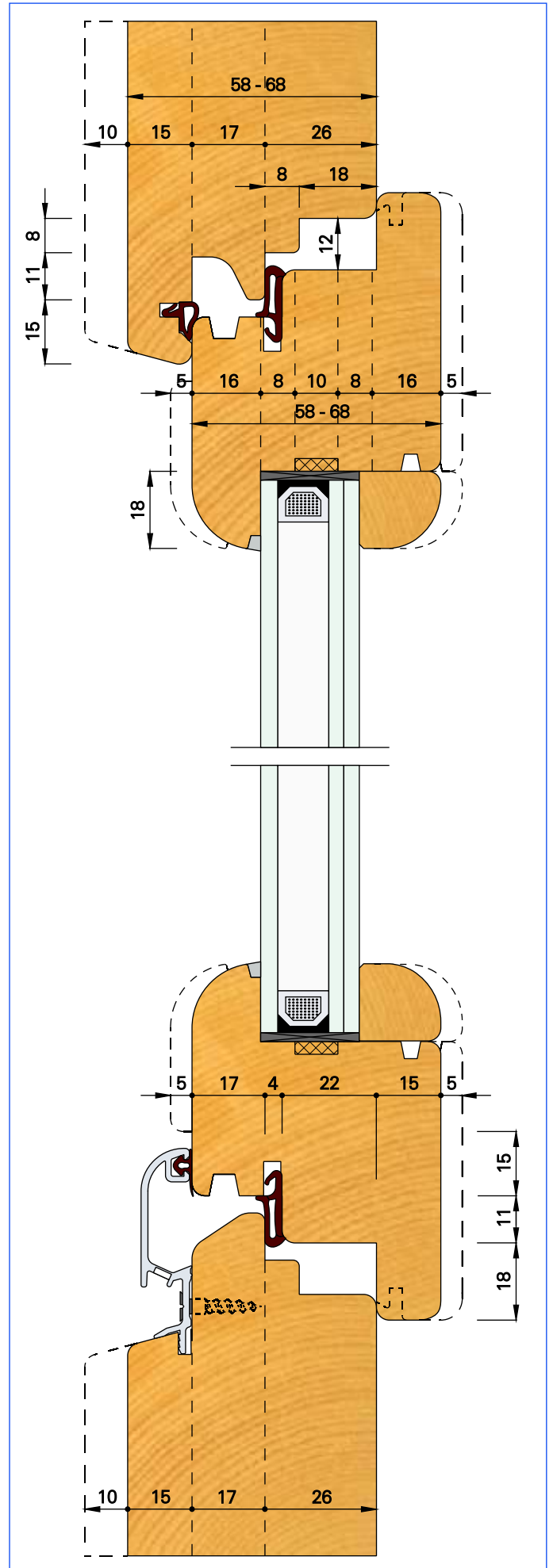
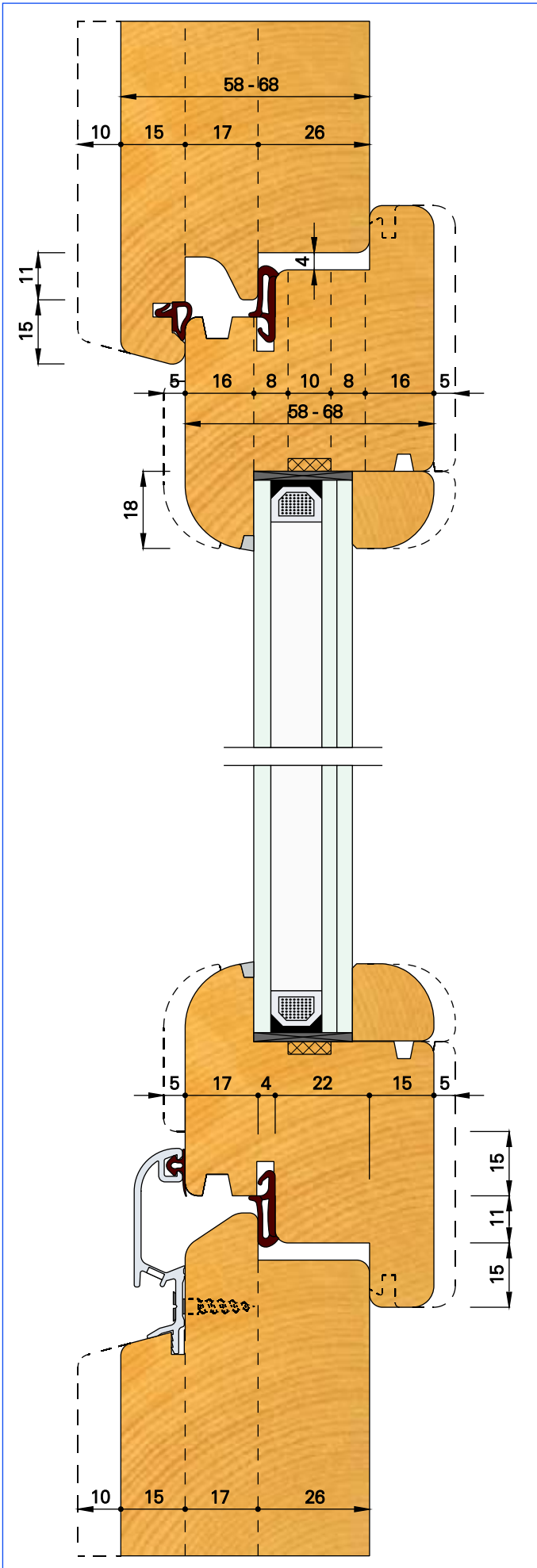

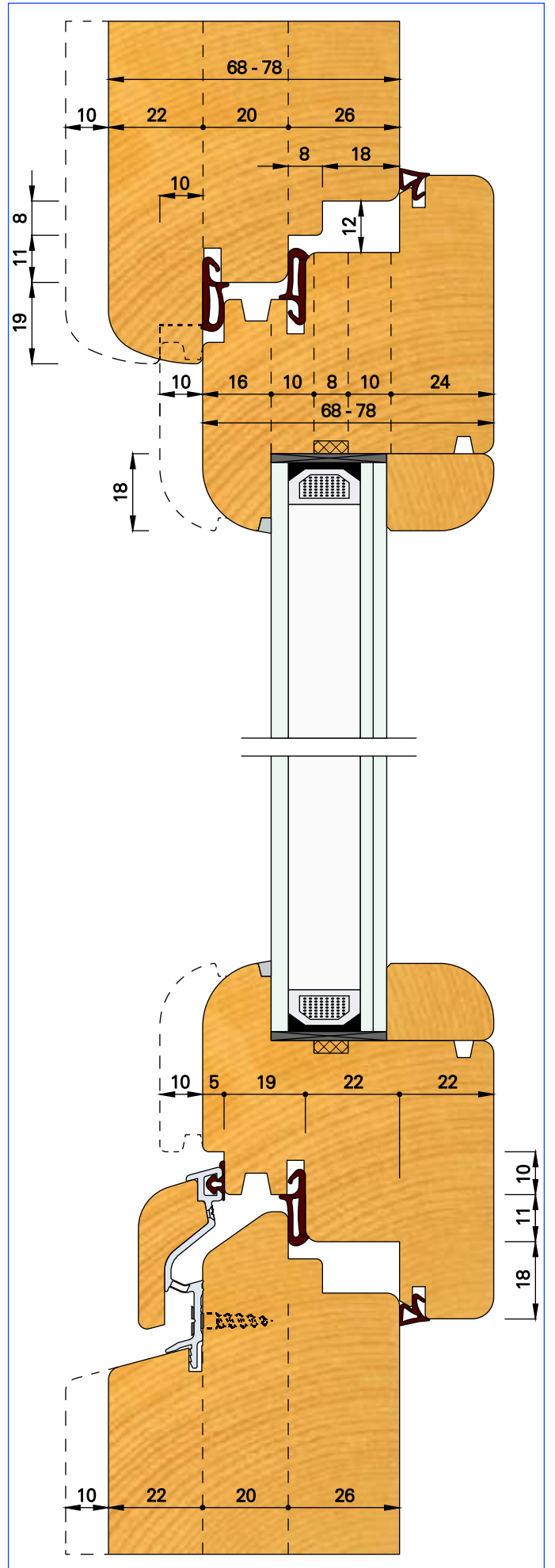
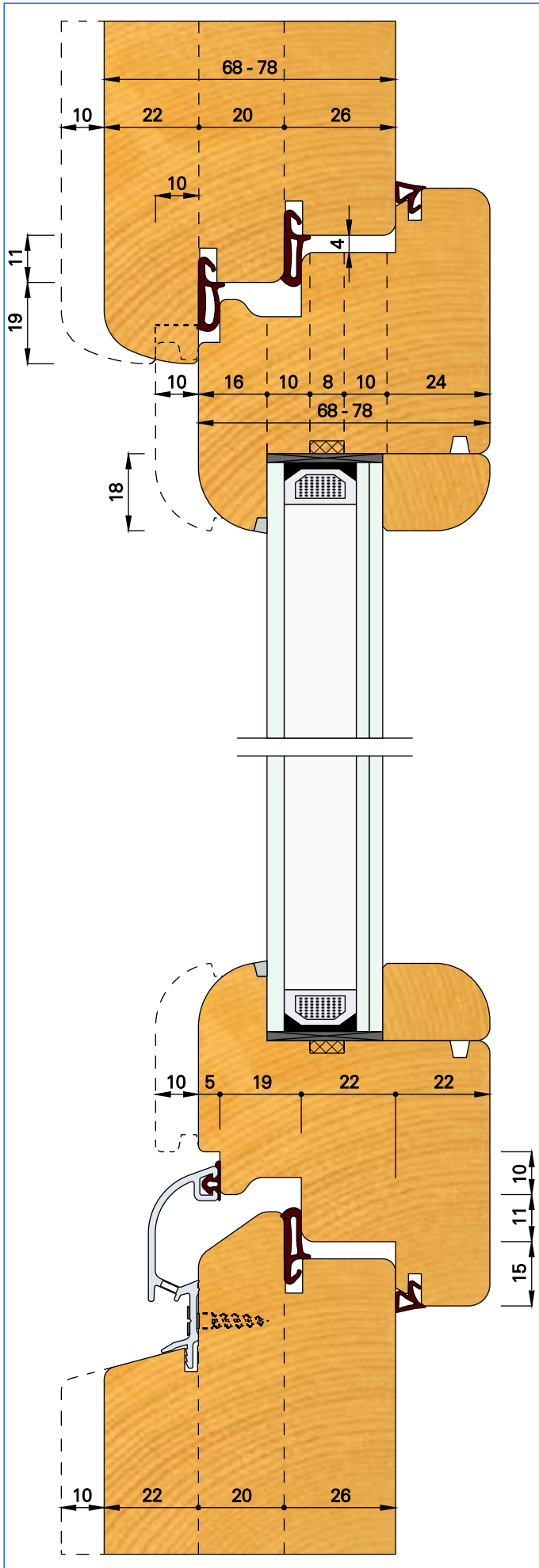

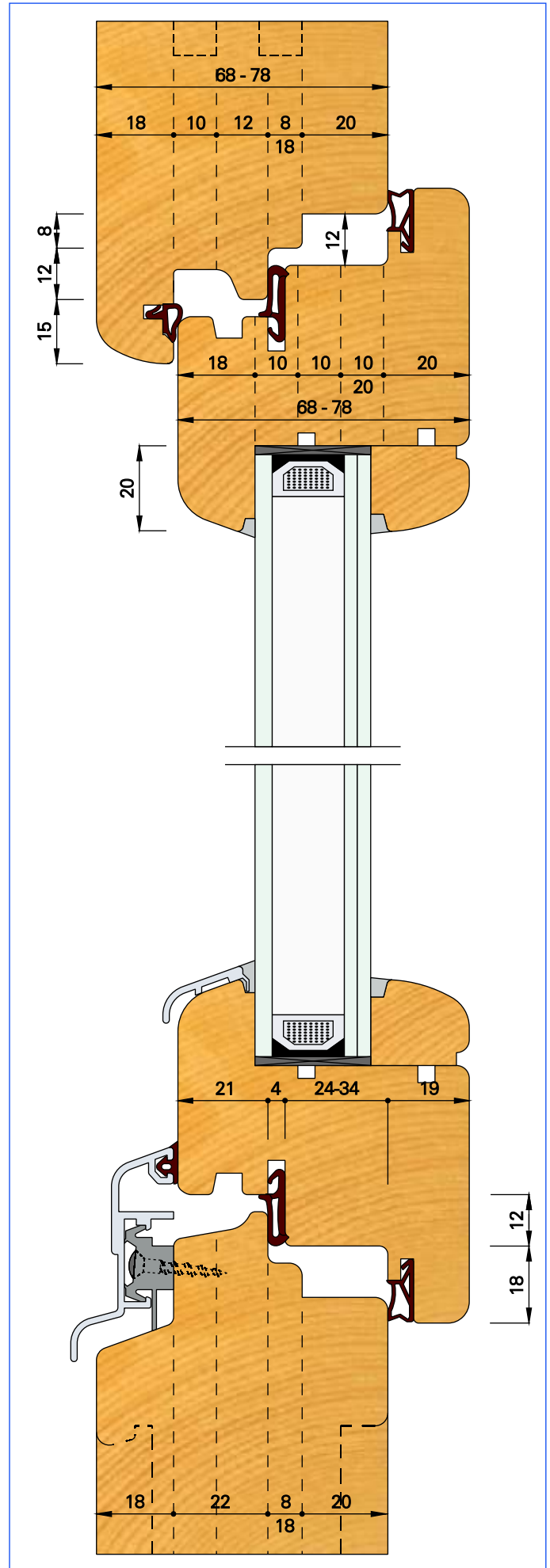
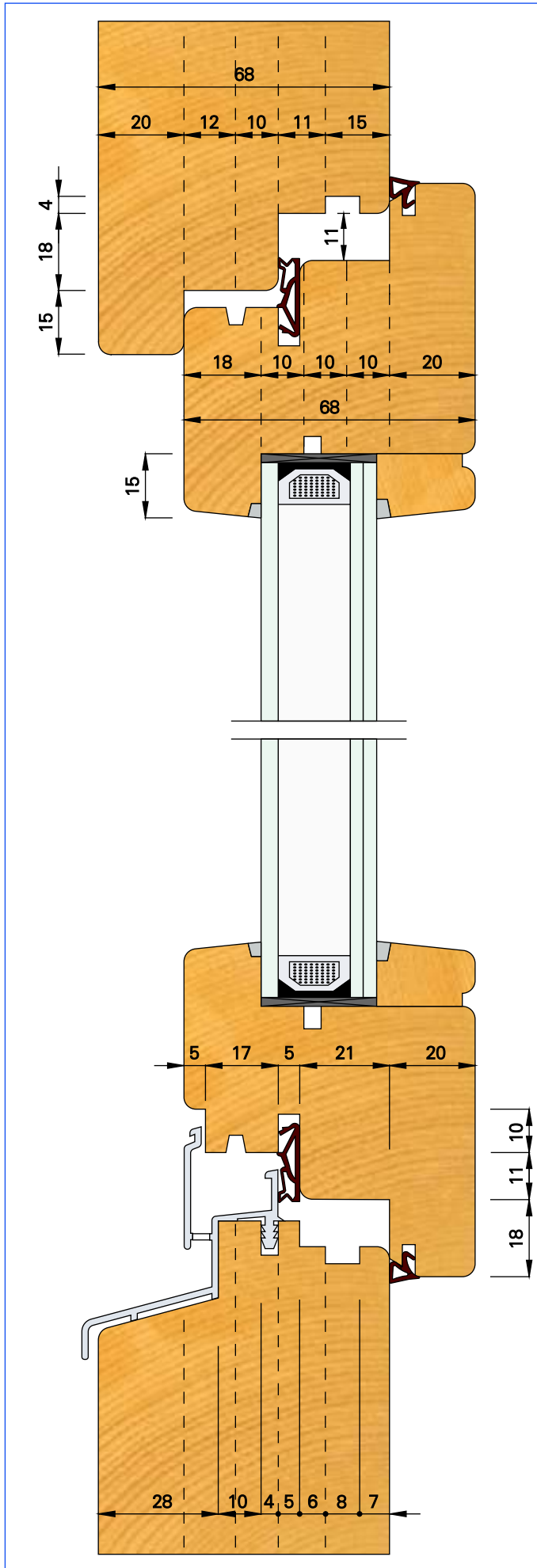

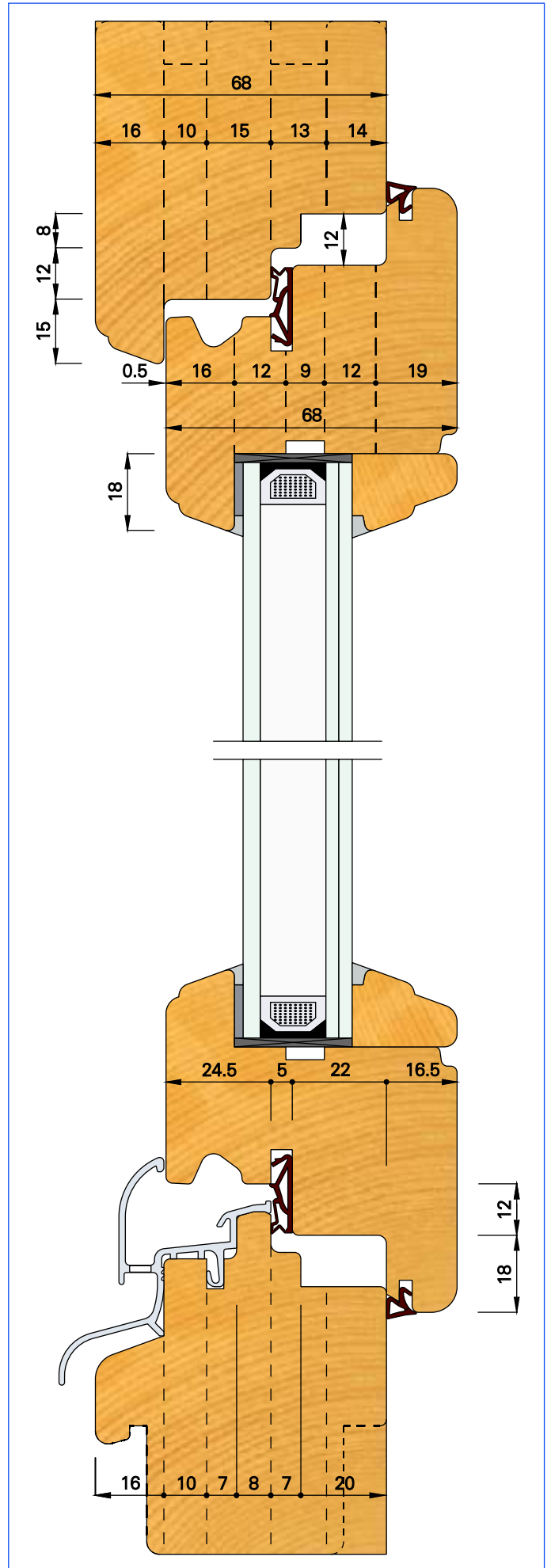
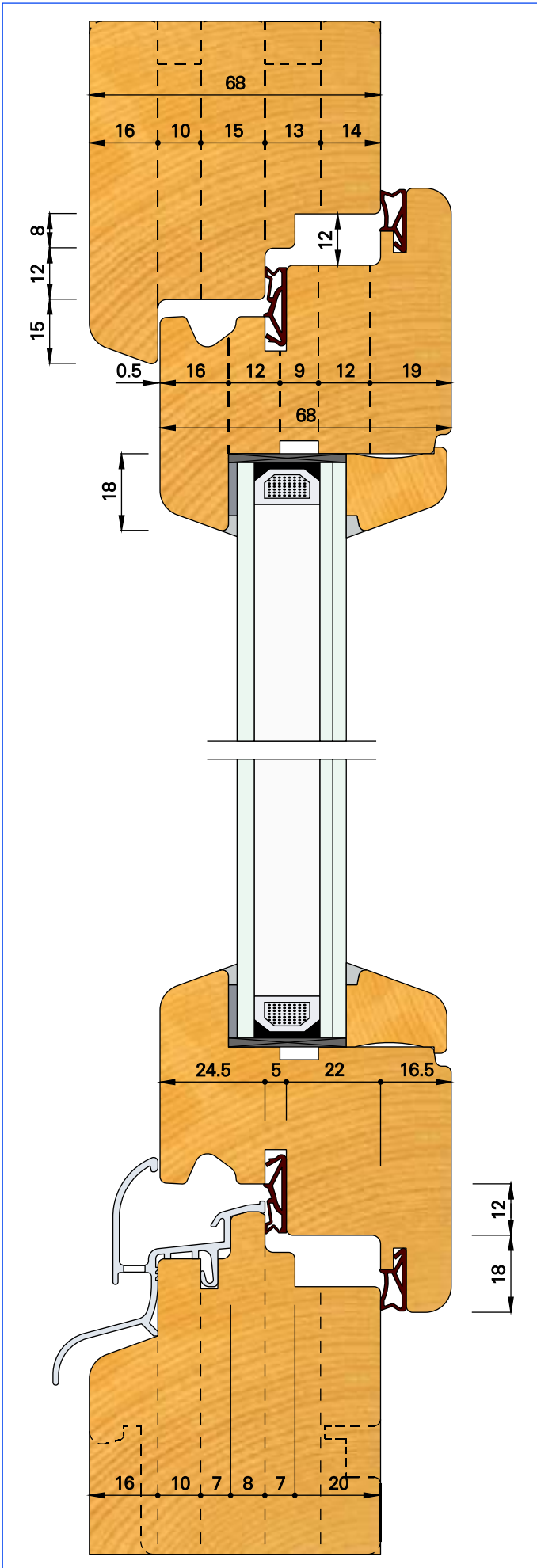

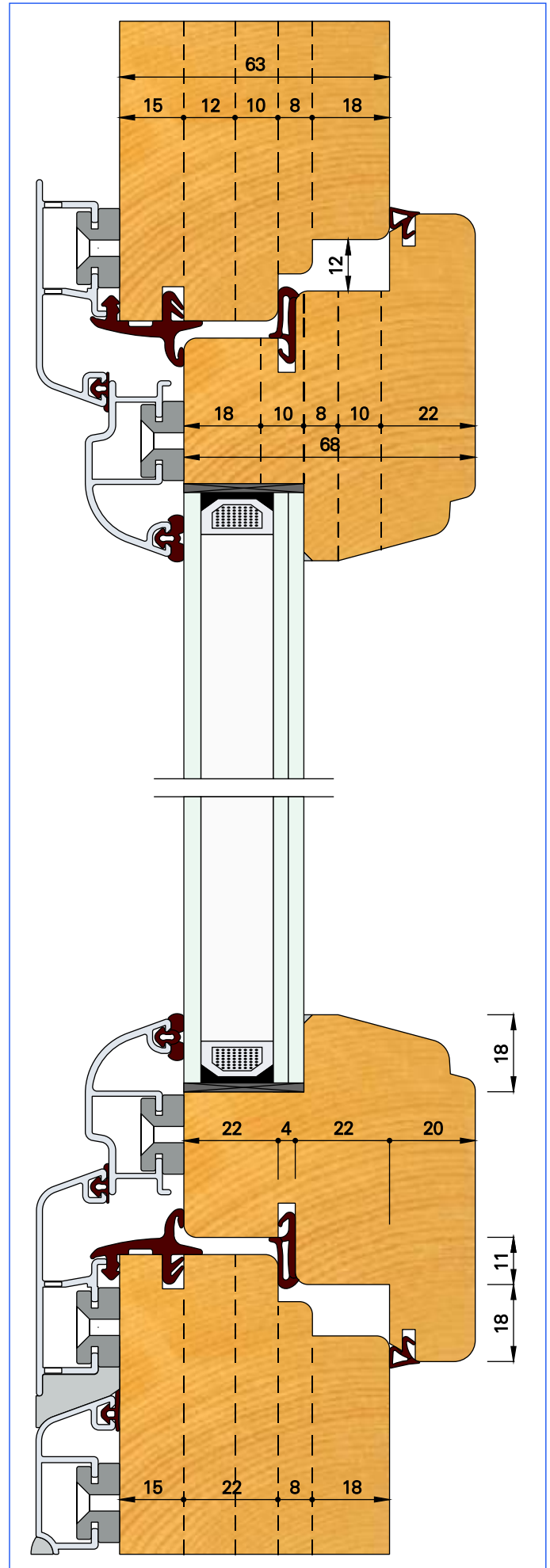
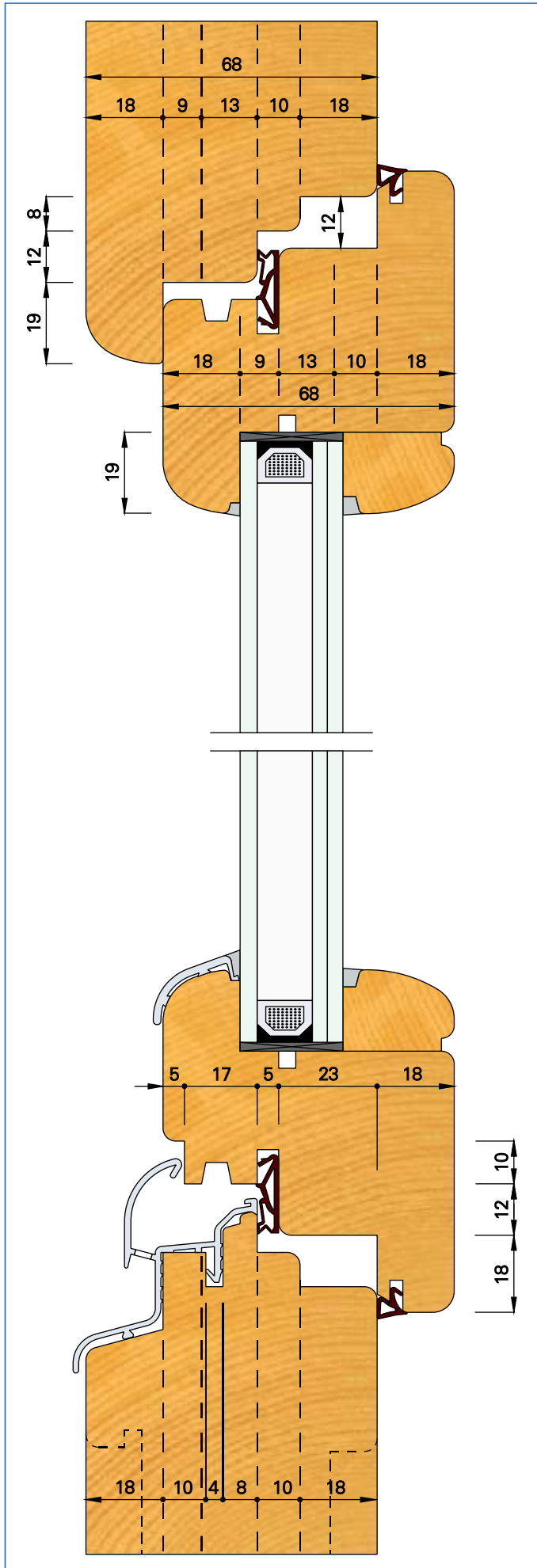

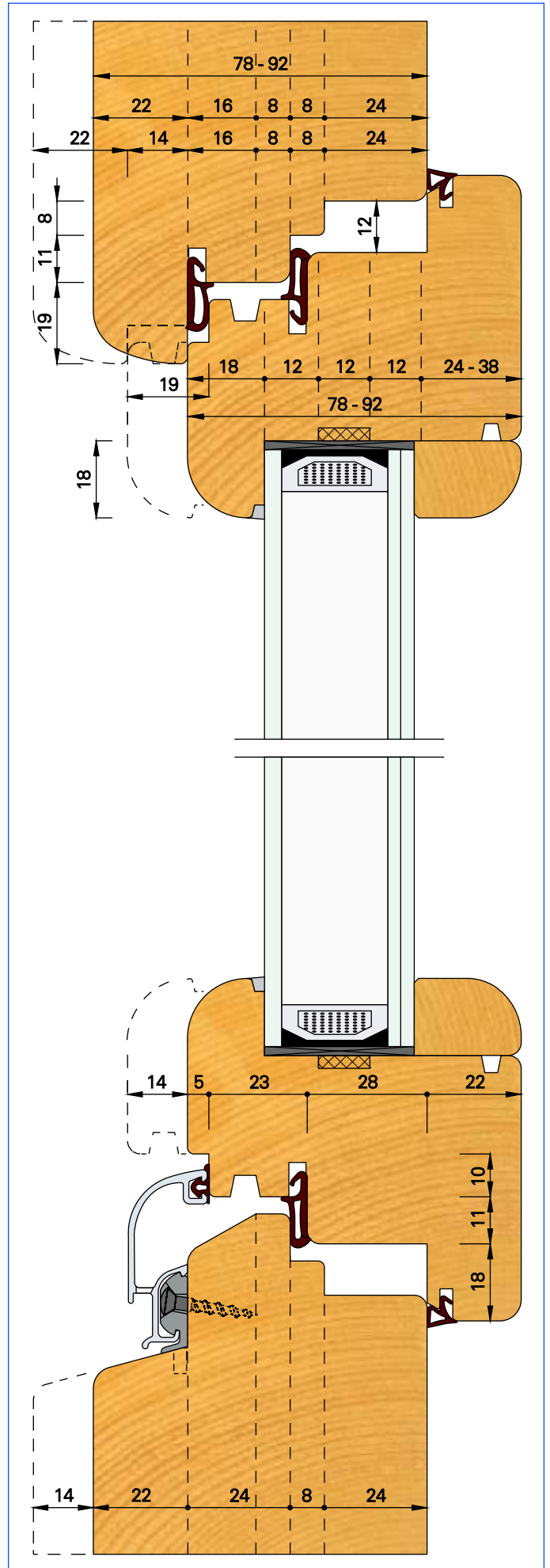
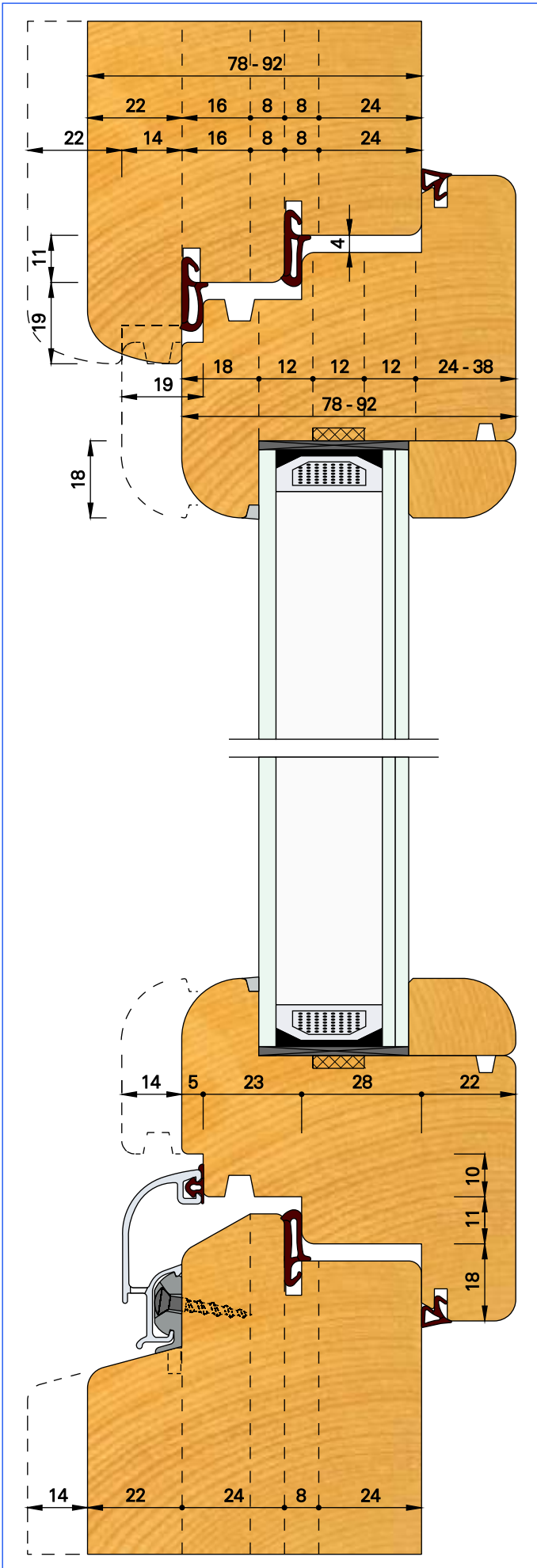

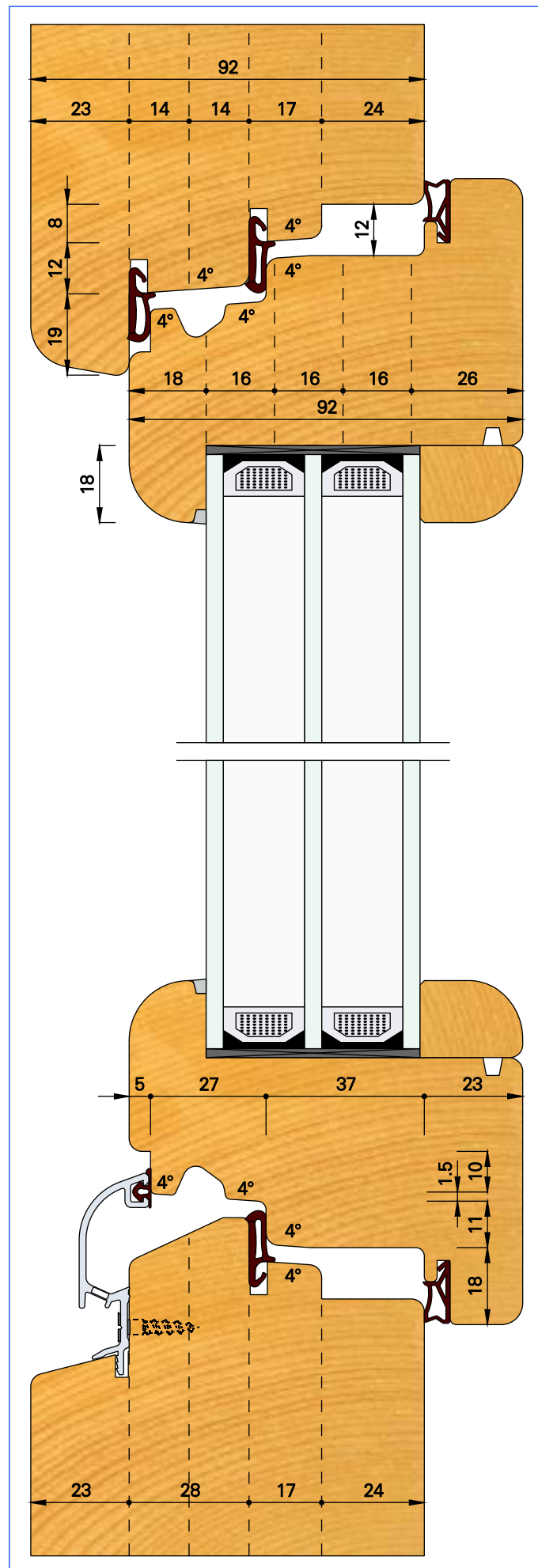
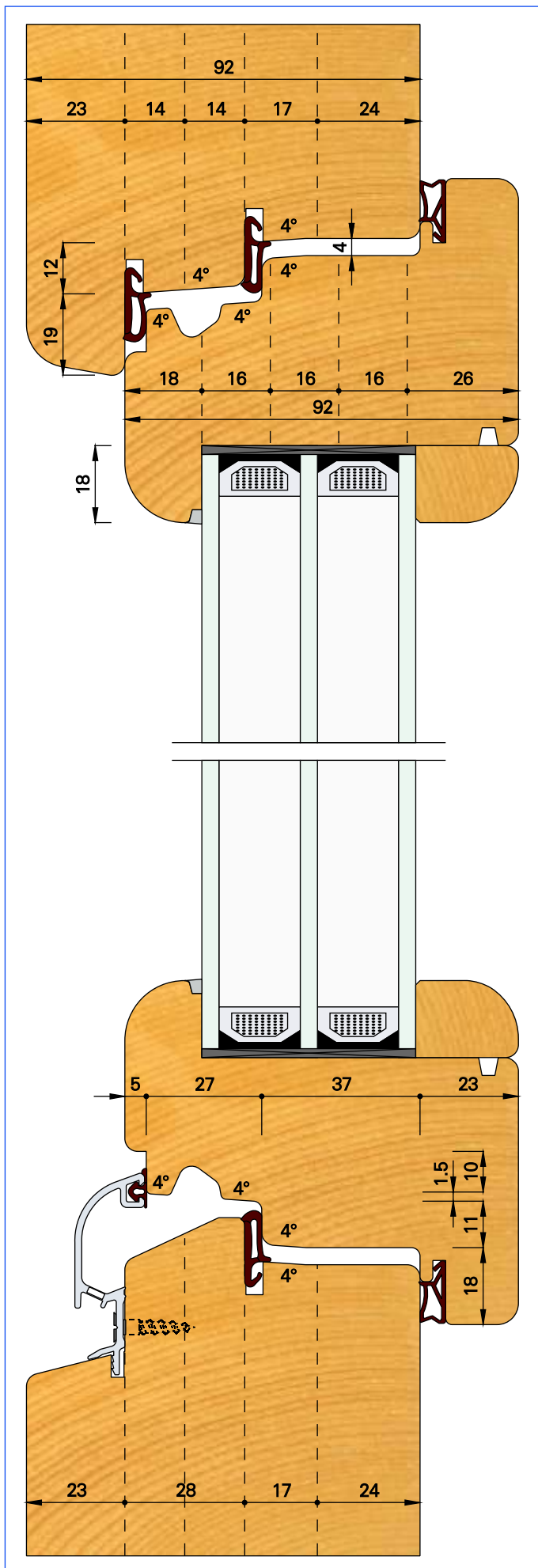

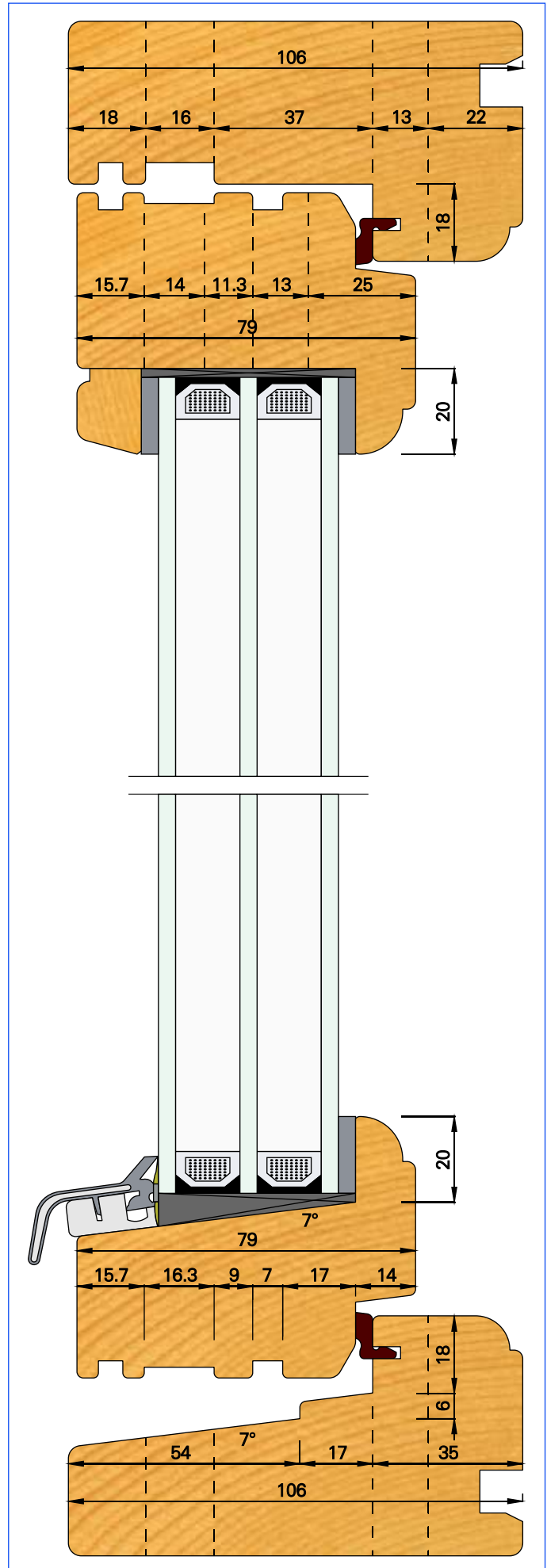
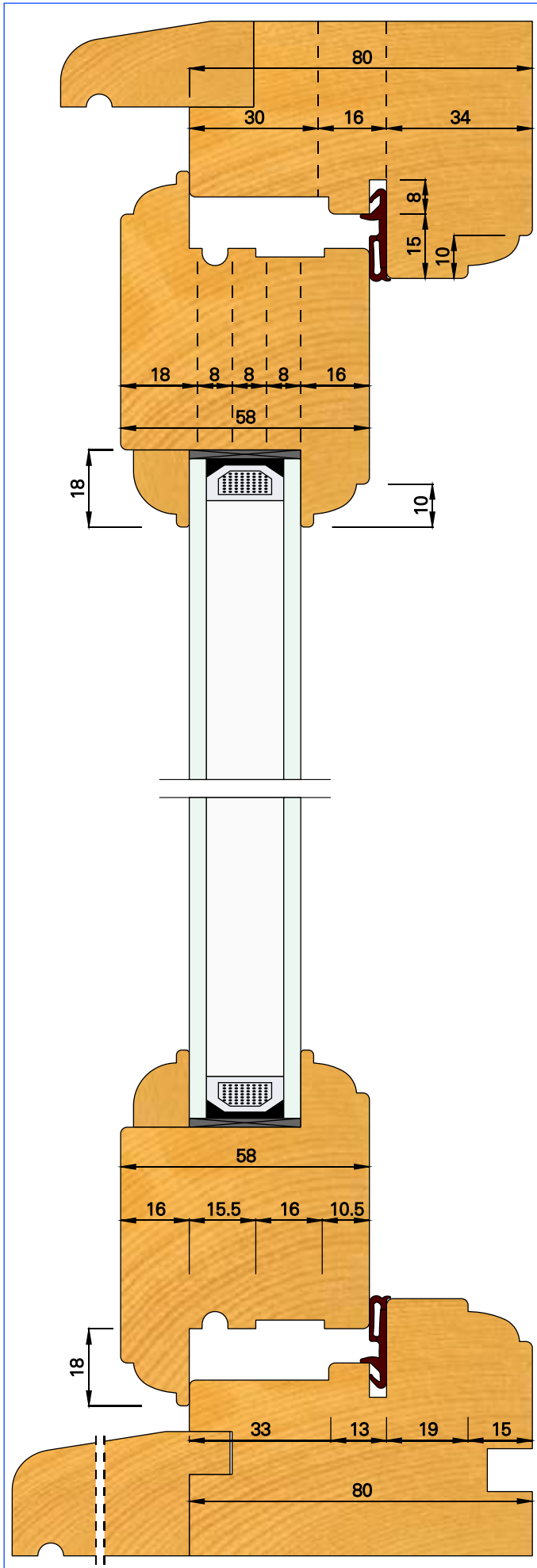



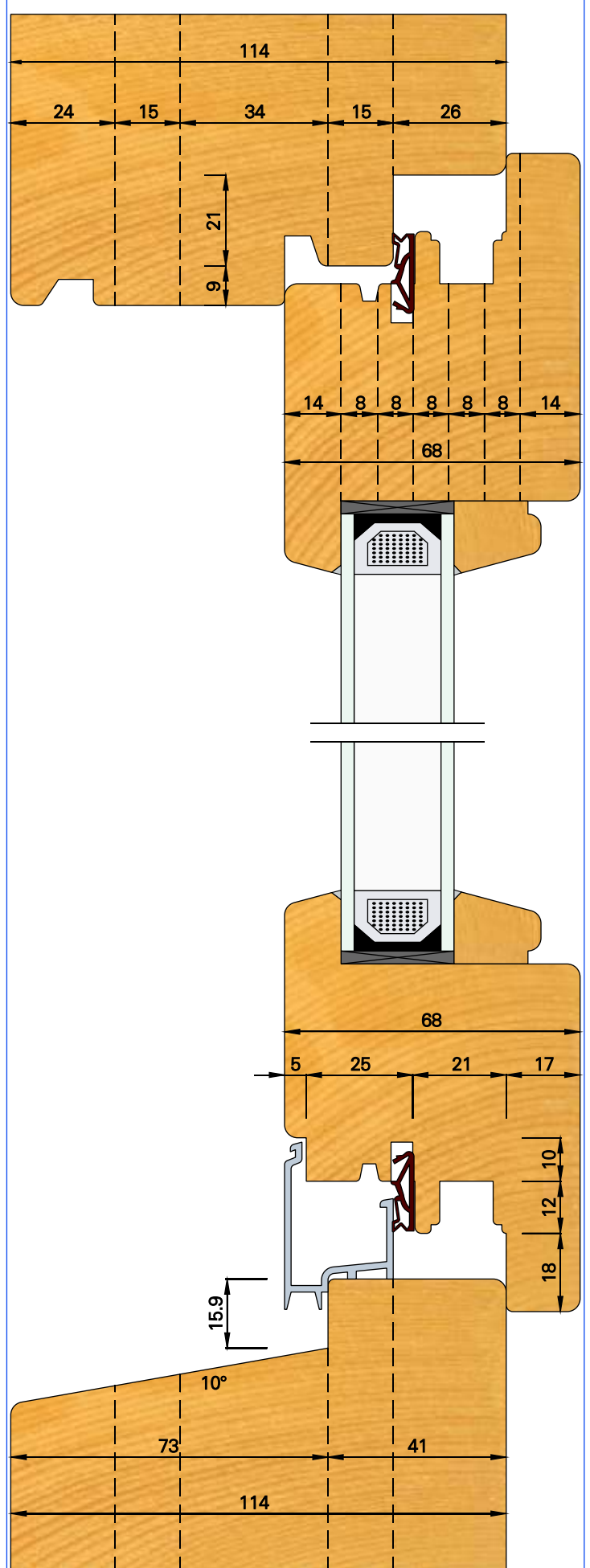
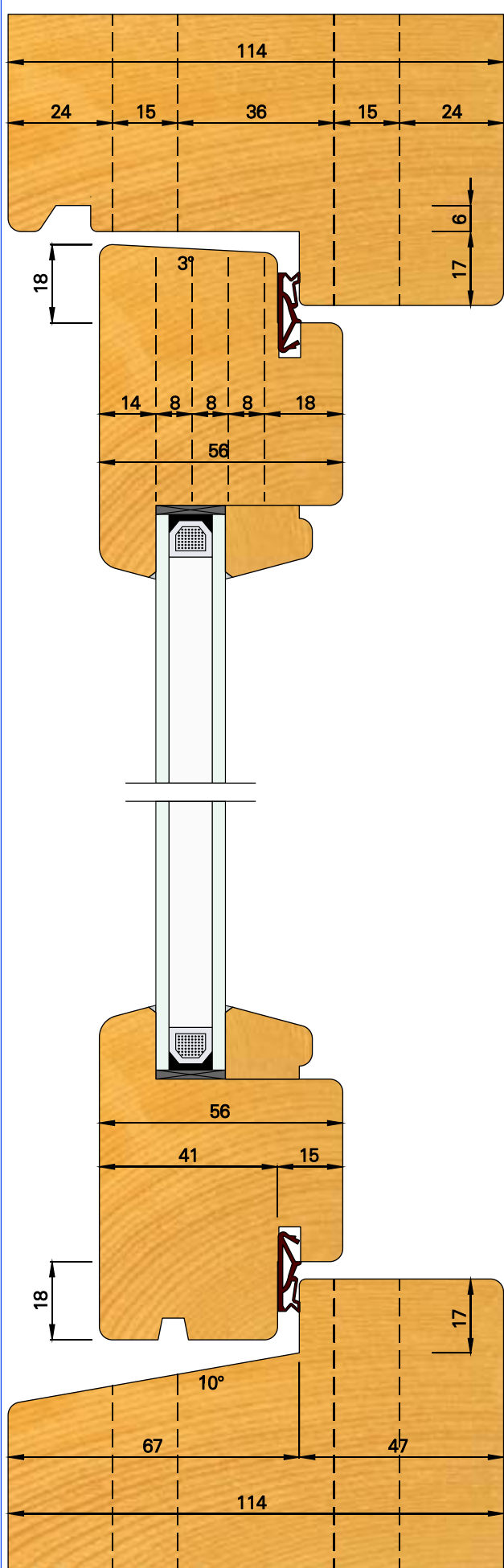



I disegni, le fotografie ed i dati tecnici relativi agli utensili illustrati in questo catalogo sono da intendersi come indicativi e possono subire modifiche, anche senza preavviso.

Questo catalogo è di proprietà esclusiva della OMAS Spa.

Tutti i diritti sono riservati a norma di legge e a norma delle convenzioni internazionali.

La riproduzione intera o parziale di questo catalogo è vietata, salvo il caso di preventiva autorizzazione scritta della OMAS Spa.

Drawings, pictures and specifications regarding the tools shown in this catalogue are approximate and may be changed, even without notice.

This catalogue belongs only to OMAS Spa.

All rights are reserved according to law and to international conventions.

Full or partial reproduction of this catalogue is forbidden if there is not a preventive written authorization from OMAS Spa.